

Annette Huber and Stefan Müller-Stach,
with contributions by Benjamin Friedrich and
Jonas von Wangenheim

Periods and Nori Motives

November 3, 2016

Springer

Contents

Part I Background Material

1	General Set-up	3
1.1	Varieties	3
1.1.1	Linearising the category of varieties	3
1.1.2	Divisors with normal crossings	4
1.2	Complex analytic spaces	5
1.2.1	Analytification	5
1.3	Complexes	6
1.3.1	Basic definitions	6
1.3.2	Filtrations	7
1.3.3	Total complexes and signs	8
1.4	Hypercohomology	9
1.4.1	Definition	10
1.4.2	Godement resolutions	11
1.4.3	Čech cohomology	13
1.5	Simplicial objects	15
1.6	Grothendieck topologies	19
1.7	Torsors	22
1.7.1	Sheaf-theoretic definition	22
1.7.2	Torsors in the category of sets	24
1.7.3	Torsors in the category of schemes (without groups)	27
2	Singular Cohomology	31
2.1	Relative cohomology	31
2.2	Singular (co)homology	34
2.3	Simplicial cohomology	35
2.4	The Künneth formula and Poincaré duality	41
2.5	The Basic Lemma	45
2.5.1	Formulations of the Basic Lemma	45
2.5.2	Direct proof of Basic Lemma I	47

2.5.3	Nori's proof of Basic Lemma II	49
2.5.4	Beilinson's proof of Basic Lemma II	52
2.5.5	Perverse sheaves and Artin vanishing	56
2.6	Triangulation of algebraic varieties	59
2.6.1	Semi-algebraic Sets	60
2.6.2	Semi-algebraic singular chains	66
2.7	Singular cohomology via the h' -topology	70
3	Algebraic de Rham cohomology	73
3.1	The smooth case	73
3.1.1	Definition	73
3.1.2	Functoriality	76
3.1.3	Cup product	77
3.1.4	Change of base field	78
3.1.5	Étale topology	80
3.1.6	Differentials with log poles	80
3.2	The general case: via the h -topology	82
3.3	The general case: alternative approaches	86
3.3.1	Deligne's method	86
3.3.2	Hartshorne's method	90
3.3.3	Using geometric motives	90
3.3.4	The case of divisors with normal crossings	93
4	Holomorphic de Rham cohomology	97
4.1	Holomorphic de Rham cohomology	97
4.1.1	Definition	97
4.1.2	Holomorphic differentials with log poles	99
4.1.3	GAGA	100
4.2	Holomorphic de Rham cohomology via the h' -topology	101
4.2.1	h' -differentials	101
4.2.2	Holomorphic de Rham cohomology	102
4.2.3	GAGA	103
5	The period isomorphism	107
5.1	The category $(k, \mathbb{Q})\text{-Vect}$	107
5.2	A triangulated category	108
5.3	The period isomorphism in the smooth case	109
5.4	The general case (via the h' -topology)	111
5.5	The general case (Deligne's method)	113
6	Categories of (mixed) motives	117
6.1	Pure motives	117
6.2	Geometric motives	119
6.3	Absolute Hodge motives	123
6.4	Mixed Tate motives	128

Part II Nori Motives

7	Nori's diagram category	135
7.1	Main results	135
7.1.1	Diagrams and representations	135
7.1.2	Explicit construction of the diagram category	137
7.1.3	Universal property: statement	138
7.1.4	Discussion of the Tannakian case	142
7.2	First properties of the diagram category	143
7.3	The diagram category of an abelian category	148
7.3.1	A calculus of tensors	148
7.3.2	Construction of the equivalence	154
7.3.3	Examples and applications	162
7.4	Universal property of the diagram category	163
7.5	The diagram category as a category of comodules	166
7.5.1	Preliminary discussion	167
7.5.2	Coalgebras and comodules	167
8	More on diagrams	175
8.1	Multiplicative structure	175
8.2	Localisation	186
8.3	Nori's rigidity criterion	189
8.4	Comparing fibre functors	193
8.4.1	The space of comparison maps	193
8.4.2	Some examples	198
8.4.3	The description as formal periods	201
9	Nori motives	205
9.1	Essentials of Nori motives	205
9.1.1	Definition	205
9.1.2	Main results	206
9.2	Yoga of good pairs	210
9.2.1	Good pairs and good filtrations	210
9.2.2	Čech complexes	211
9.2.3	Putting things together	214
9.2.4	Comparing diagram categories	216
9.3	Tensor structure	218
9.3.1	Collection of proofs	223
9.4	Artin motives	224
9.5	Change of fields	226
10	Weights and pure Nori motives	231
10.1	Comparison functors	231
10.2	Weights and Nori motives	235
10.2.1	André's motives	235

10.2.2 Weights	236
10.3 Tate motives	239

Part III Periods

11 Periods of varieties	245
11.1 First definition	245
11.2 Periods for the category $(k, \mathbb{Q})\text{-Vect}$	248
11.3 Periods of algebraic varieties	251
11.3.1 Definition	251
11.3.2 First properties	253
11.4 The comparison theorem	254
11.5 Periods of motives	256
12 Kontsevich–Zagier periods	259
12.1 Definition	259
12.2 Comparison of definitions of periods	263
13 Formal periods and the period conjecture	271
13.1 Formal periods and Nori motives	271
13.2 The period conjecture	275
13.2.1 Formulation in the number field case	276
13.2.2 Consequences	277
13.2.3 Special cases and the older literature	280
13.2.4 The function field case	282
13.3 The case of 0-dimensional varieties	285

Part IV Examples

14 Elementary examples	289
14.1 Logarithms	289
14.2 More logarithms	291
14.3 Quadratic forms	292
14.4 Elliptic curves	294
14.5 Periods of 1-forms on arbitrary curves	299
15 Multiple zeta values	305
15.1 A ζ -value, the basic example	305
15.2 Definition of multiple zeta values	308
15.3 Kontsevich’s integral representation	310
15.4 Relations among multiple zeta values	312
15.5 Multiple zeta values and moduli space of marked curves	318
15.6 Multiple Polylogarithms	318
15.6.1 The configuration	319
15.6.2 Singular homology	320
15.6.3 Smooth singular homology	323

15.6.4 Algebraic de Rham cohomology and the period matrix of (X, D)	324
15.6.5 Varying the parameters a and b	328
16 Miscellaneous periods: an outlook	335
16.1 Special values of L -functions	335
16.2 Feynman periods	338
16.3 Algebraic cycles and periods	340
16.4 Periods of homotopy groups	344
16.5 Exponential periods	346
16.6 Non-periods	347
References	351
Index	361

Preface, with an extended Introduction

The aim of this book is to present the theory of period numbers and their structural properties. The second main theme is the theory of motives and cohomology which lies behind these structural properties.

The genesis of this book is involved. Some time ago we were fascinated by a theorem of Kontsevich [Kon99], stating that his algebra of formal periods is a pro-algebraic torsor under the motivic Galois group of motives. He attributed this result to Nori, but no proof was indicated.

We came to understand that it would indeed follow more or less directly from Nori's unpublished description of an abelian category of motives. After realising this, we started to work out many details in our preprint [HMS11] from 2011.

Over the years we have also realised that periods themselves generate a lot of interest, very often from non-specialists who are not familiar with all the techniques contributing to the story. Hence we thought it would be worthwhile to make this background accessible to a wider audience.

We started to write this monograph in a style that is also suited for non-expert readers by adding several introductory chapters and many examples.

General introduction

So what are periods?

A naive point of view

Period numbers are complex numbers defined as values of integrals

$$\int_{\gamma} \omega$$

of closed differential forms ω over certain domains of integration γ . Without giving a precise definition at this point, let us just mention that one requires restrictive conditions on ω and γ , i.e., that γ is a region given by (semi-)algebraic equations with rational coefficients, and the differential form ω is algebraic over \mathbb{Q} . An analogous definition can be made for other fields, but we only consider the main case $k = \mathbb{Q}$ in this introduction.

Many interesting numbers occurring in mathematics can be described in this form:

1. $\log(2)$ is a period because $\int_1^2 \frac{dx}{x} = \log(2)$.
2. π is a period because $\int_{x^2+y^2 \leq 1} dx dy = \pi$.
3. The Cauchy integral yields a complex period

$$\int_{|z|=1} \frac{dz}{z} = 2\pi i.$$

4. Values of the Riemann zeta function such as

$$\zeta(3) = \sum_{n=1}^{\infty} \frac{1}{n^3} = \int_{0 < x < y < z < 1} \frac{dx dy dz}{(1-x)yz}$$

are period numbers as well.

5. More generally, all *multiple zeta values* (see Chapter 15) are period numbers.
6. A basic observation is that all algebraic numbers are periods, e.g., $\sqrt{5}$ can be obtained by integrating the differential form dx on the algebraic curve $y = x^2$ over the real region where $0 \leq y \leq 5$ and $x \geq 0$.

Period numbers turn up in many parts of mathematics, sometimes in very surprising situations. Of course, they are fundamental objects in number theory and have been studied from different points of view. They also generate a lot of interest in mathematical physics because Feynman integrals for rational values of kinematical invariants are period numbers.

It is easy to write down periods. It is much harder to write down numbers which are non-periods. This is surprising, given that the set of all period numbers is a countable algebra containing $\bar{\mathbb{Q}}$. Indeed, we expect that π^{-1} and the Euler number e are non-periods, but this is not known. We refer to Section 16.6 for an actual, not too explicit, example of a non-period.

It is as hard to understand linear or algebraic relations between periods. This aspect of the story starts with Lindemann's 1882 proof of the transcendence of π and the transcendence of $\log(x)$ for $x \in \bar{\mathbb{Q}} \setminus \{0, 1\}$. Grothendieck formulated a conjecture on the transcendence degree of the field generated

by the periods of any smooth projective variety. Historical traces of his ideas seem to go back at least to Leibniz, see Chapter 13. The latest development is Kontsevich–Zagier’s formulation of a period conjecture for the algebra of all periods: the only relations are those induced from the obvious ones, i.e., from functoriality and long exact sequences in cohomology (see p. xv and Chapter 13). The conjecture is very deep. As a very special case it implies the transcendence of $\zeta(n)$ for n odd. This is wide open, the best available results being the irrationality of $\zeta(3)$ and an infinity of irrational odd zeta values.

While this aspect is interesting and important, we really have almost nothing to say about it. Instead, we aim at explaining a more conceptual interpretation of period numbers and shedding light on some structural properties of the algebra of periods numbers.

As an aside: Periods of integrals are also used in the theory of moduli of algebraic varieties. Given a family of projective varieties, Griffiths defined a map into a period domain by studying the function given by varying period numbers. We are not concerned with this point of view either.

A more conceptual point of view

The period integral $\int_{\gamma} \omega$ actually only depends on the class of ω in de Rham cohomology and on the class of γ in singular homology. Integration generalises to the *period pairing* between algebraic de Rham cohomology and singular homology. It has values in \mathbb{C} , and the period numbers are precisely its image. Alternatively, one can formulate the relation as a *period isomorphism* between algebraic de Rham cohomology and singular cohomology — after extension of scalars to \mathbb{C} . The period isomorphism is then described by a matrix whose entries are periods. The most general situation one can allow here is *relative cohomology* of a possibly singular, possibly non-complete algebraic variety over \mathbb{Q} with respect to a closed subvariety also defined over \mathbb{Q} .

In formulas: For a variety X over \mathbb{Q} , a closed subvariety Y over \mathbb{Q} , and every $i \geq 0$, there is an isomorphism

$$\text{per} : H_{\text{dR}}^i(X, Y) \otimes_{\mathbb{Q}} \mathbb{C} \rightarrow H_{\text{sing}}^i(X^{\text{an}}, Y^{\text{an}}; \mathbb{Q}) \otimes_{\mathbb{Q}} \mathbb{C},$$

where X^{an} denotes the analytic space attached to X . If X is smooth, X^{an} is simply the complex manifold defined by the same equations as X . The really important thing to point out is the fact that this isomorphism does not respect the \mathbb{Q} -structures on both sides. Indeed, consider $X = \mathbb{A}^1 \setminus \{0\} = \text{Spec}(\mathbb{Q}[T, T^{-1}])$ and $Y = \emptyset$. The first de Rham cohomology group is one-dimensional and generated by $\frac{dT}{T}$. The first singular cohomology is also one-dimensional, and generated by the dual of the unit circle in $X^{\text{an}} = \mathbb{C}^*$. The comparison factor is the period integral $\int_{S^1} \frac{dT}{T} = 2\pi i$.

Relative singular cohomology of pairs is a standard notion of algebraic topology. The analogue on the de Rham side is much less known, in particular if X and Y are no longer smooth. Experts have been familiar with very general versions of algebraic de Rham cohomology as by-products of advanced Hodge theory, but no elementary discussion seems to be in the literature. One of our intentions is to provide this here in some detail.

An even more conceptual point of view

An even better language to describe periods is the language of motives. The concept was introduced by Grothendieck in his approach to the Weil conjectures. Philosophically, motives are objects in a universal abelian category attached to the category of algebraic varieties whose most important property is to have cohomology: singular and de Rham cohomology in our case. Every variety has a motive $h(X)$ which should decompose into components $h^i(X)$ for $i = 0, \dots, 2 \dim X$. Singular cohomology of $h^i(X)$ is concentrated in degree i and equal to $H_{\text{sing}}^i(X^{\text{an}}, \mathbb{Q})$ there.

Impressive progress has been made. In particular, we now have unconditional constructions. However, the full picture remains conjectural. For pure motives — the ones attached to smooth projective varieties — there is an unconditional construction due to Grothendieck, but their expected properties depend on a choice of equivalence relations and hence on the standard conjectures. An alternative unconditional definition was given by André. His category is abelian and has many of the expected properties, but the full universal property is lacking unless one assumes the standard conjectures. In the mixed case — considering all varieties whether smooth or not — there are (at least) three candidates for an abelian category of mixed motives: the absolute Hodge motives of Deligne and Jannsen, Nori's category, and Ayoub's category. The categories of Nori and Ayoub are now known to agree. Moreover, pure Nori motives are motives in the sense of André. There are also a number of constructions of triangulated motivic categories (due to Hanamura, Levine and Voevodsky) which we think of as derived categories of the true category of mixed motives. They turn out to be equivalent. The relation between triangulated and abelian categories of motives remains the biggest open question.

All standard properties of cohomology are assumed to be induced by properties of the category of motives: the Künneth formula for the product of two varieties is induced by a tensor structure on motives; Poincaré duality is induced by the existence of strong duals on motives. In fact, every abelian category of motives (conjectural or candidate) is a rigid tensor category. Singular cohomology is (supposed to be) a faithful and exact tensor functor on this tensor category. Hence, we have a Tannaka category. By the main theorem of Tannaka theory, the category has a Tannaka dual: an affine pro-algebraic

group scheme whose finite-dimensional representations are precisely mixed motives. This group scheme is the *motivic Galois group* G_{mot} .

This viewpoint admits a reinterpretation of the period algebra: singular and de Rham cohomology are two fibre functors on the same Tannaka category, hence there is a torsor of isomorphisms between them. The period isomorphism is nothing but a \mathbb{C} -valued point of this torsor.

While the finer points of the theory of motives are still in development, the good news is that at least the definition of the period algebra does not depend on the particular definition chosen. This is in fact one of the main results in the present book, see Chapter 11.5. Indeed, all variants of the definition yield the same set of numbers, as we show in Part III. Among those are versions via cohomology of arbitrary pairs of varieties, or only those of smooth varieties relative to divisors with normal crossings, or via semi-algebraic simplices in \mathbb{R}^n , and alternatively, with rational or only regular differential forms, and with rational or algebraic coefficients.

Nevertheless, the point of view of Nori's category of motives turns out to be particularly well-suited to the treatment of periods. Indeed, the most natural proof of the comparison results mentioned above is done in the language of Nori motives, see Chapter 13. This approach also fits nicely with the formulation of the period conjectures of Grothendieck and Kontsevich.

The period conjecture

Kontsevich in [Kon99] introduces a *formal period algebra* $\tilde{\mathbb{P}}^{\text{eff}}$ whose \mathbb{Q} -linear generators are given by quadruples (X, Y, ω, γ) with X an algebraic variety over \mathbb{Q} , Y a closed subvariety, ω a class in $H_{\text{dR}}^n(X, Y)$ and $\gamma \in H_n^{\text{sing}}(X^{\text{an}}, Y^{\text{an}}, \mathbb{Q})$. There are three types of relations:

1. linearity in ω and γ ;
2. functoriality with respect to morphisms $f : (X, Y) \rightarrow (X', Y)$, i.e.,

$$(X, Y, f^*\omega, \gamma) \sim (X', Y, \omega, f_*\gamma);$$

3. compatibility with respect to connecting morphisms, i.e., for $Z \subset Y \subset X$ and $\delta : H_{\text{dR}}^{n-1}(Y, Z) \rightarrow H_{\text{dR}}^n(X, Y)$

$$(Y, Z, \omega, \partial\gamma) \sim (X, Y, \delta\omega, \gamma).$$

The set $\tilde{\mathbb{P}}^{\text{eff}}$ becomes an algebra using the cup-product on cohomology. The relations are defined in such a way that there is a natural evaluation map

$$\tilde{\mathbb{P}}^{\text{eff}} \rightarrow \mathbb{C}, \quad (X, Y, \omega, \gamma) \mapsto \int_{\gamma} \omega.$$

(Actually this is a variant of the original definition, see Chapter 13.) In a second step, we localise with respect to the class of $(\mathbb{A}^1 \setminus \{0\}, \{1\}, dT/T, S^1)$, i.e., the formal period giving rise to $2\pi i$. Essentially by definition, the image of $\tilde{\mathbb{P}}$ is the period algebra.

Conjecture (Kontsevich–Zagier Conjecture, or Period Conjecture)

The evaluation map is injective.

Again, we have nothing to say about this conjecture. However, it shows that the elementary object $\tilde{\mathbb{P}}$ is quite natural in our context.

One of the main results in this book is the following result of Nori, which is already stated in [Kon99].

Theorem 13.1.4 *The formal period algebra $\tilde{\mathbb{P}}$ is a torsor under the motivic Galois group in the sense of Nori, i.e., of the Tannaka dual of Nori’s category of motives.*

Under the period conjecture, this should be read as a deep structural result about the period algebra.

The main aims of this book

The main goal of this book is to explain all the notions mentioned above, give complete proofs, and discuss a number of examples of particular interest.

- We explain singular cohomology, algebraic de Rham cohomology and the period isomorphism.
- We introduce Nori’s abelian category of mixed motives and the necessary generalisation of Tannaka theory needed for its definition.
- Various notions of period numbers are introduced and compared.
- The relation of the formal period algebra to period numbers and the motivic Galois group is explained.
- We work out examples like periods of curves, multiple zeta values, Feynman integrals and special values of L -functions.

We strive for a reasonably self-contained presentation aimed also at non-specialists and graduate students.

Relation to the existing literature

Both periods and the theory of motives have a long and rich history. We prefer not to attempt a historical survey, but rather mention the papers closest to the present book.

The definition of the period algebra was folklore for quite some time. The explicit versions we are treating are due to Kontsevich and Zagier in [Kon99] and [KZ01].

Nori's theory of motives became known through a series of talks that he gave, and notes of these talks that started to circulate, see [Nor00], [Nora]. Levine's survey article in [Lev05] sketches the main points.

The relation between (Nori) motives and formal periods is formulated by Kontsevich [Kon99].

Finally, we would like to mention André's monograph [And04]. Superficially, there is a lot of overlap (motives, Tannaka theory, periods). However, as our perspective is very different, we end up covering a lot of disjoint material as well. We recommend that anyone interested in a deeper understanding also study his exposition.

Recent developments

The ideas of Nori have been taken up by other people in recent years, leading to a rapid development of understanding. We have refrained from trying to incorporate all these results. It is too early to know what the final version of the theory will be. However, we would like to give at least some indications of the direction in which things are going. The category theoretical aspect of the construction of Nori motives has been generalised. Ivorra in [Ivo14] establishes the existence of a universal abelian category attached to the representation of a diagram in a \mathbb{Q} -linear abelian category satisfying finiteness assumptions. Barbieri-Viale, Caramello, L. Lafforgue and Prest have taken the generalisation much further, see [BVCL15], [BV15a], [BVP16].

The construction of Nori motives themselves has been generalised to categories over a base S by Arapura in [Ara13] and Ivorra [Ivo14]. Arapura's approach is based on constructible sheaves. His categories allow pull-back and push-forward functors, the latter being a deep result. The same paper also constructs the weight filtration on Nori motives and establishes the equivalence between Nori motives and André's pure motives. Ivorra's approach is based on perverse sheaves. The existence of the six functors formalism is open in his setting.

Harrer's thesis [Har16] gives full proofs (based on Nori's sketch in [Nor02]) of the construction of the realisation functor from Voevodsky's geometric motives to Nori motives. A comparison result of a different flavour was obtained by Choudhury and Gallauer [CGAdS14]: they are able to show that

Nori's motivic Galois group agrees with Ayoub's. The latter is defined via the Betti realisation functor on triangulated motives over an arbitrary base. This formally yields a Hopf object in a derived category of vector spaces. It is a deep result of Ayoub's that the cohomology of this Hopf object is only concentrated in non-negative degrees. Hence its H^0 is a Hopf algebra, the algebra of functions on Ayoub's motivic Galois group.

The relation between these two objects, whose construction is very different, can be seen as a strong indication that Nori motives are really the true abelian category of mixed motives. One can strengthen this to the conjecture that Voevodsky motives are the derived category of Nori motives.

In the same way as for other questions about motives, the case of 1-motives can be hoped to be more accessible and a very good testing ground for this type of conjecture. Ayoub and Barbieri-Viale have shown in [ABV15] that the subcategory of 1-motives in Nori motives agrees with Deligne's 1-motives, and hence also with 1-motives in Voevodsky's category.

An application of Nori motives to quadratic forms was worked out by Cassou-Nougès and Morin, see [CNM15].

There has also been progress on the period aspect of our book. Ayoub, in [Ayo15], proved a version of the period conjecture in families. There is also independent unpublished work of Nori on a similar question [Norb].

We now turn to a more detailed description of the actual contents of our book.

Nori motives and Tannaka duality

Motives are supposed to be the objects of a universal abelian category through which all cohomology theories factor. In this context, a *cohomology theory* means a (mixed) Weil cohomology theory with properties modelled on singular cohomology. A more refined example of a mixed Weil cohomology theory is the mixed Hodge structure on singular cohomology as defined by Deligne. Another one is ℓ -adic cohomology of the base change of the variety to the algebraic closure of the ground field. The ℓ -adic cohomology carries a natural operation of the absolute Galois group of the ground field. Key properties are for example a Künneth formula for the product of algebraic varieties. There are other cohomology theories of algebraic varieties which do not follow the same pattern. Examples are Chow groups, algebraic K -theory, Deligne cohomology or étale cohomology over the ground field. In all these cases the Künneth formula fails.

Coming back to theories similar to singular cohomology: they all take values in rigid tensor categories, and this is how the Künneth formula makes sense. We expect the conjectural abelian category of mixed motives to also be a Tannakian category with singular cohomology as a fibre functor, i.e.,

a faithful exact tensor functor to \mathbb{Q} -vector spaces. Nori takes this as the starting point of his definition of his candidate for the category of mixed motives. His category is universal for all cohomology theories comparable to singular cohomology. This is not quite what we hope for, but it does in fact cover all examples we have.

Tannaka duality is built into the very definition. The construction has two main steps:

1. Nori first defines an abelian category which is universal for all cohomology theories compatible with singular cohomology. By construction, it comes with a functor from the category of pairs (X, Y) where X is a variety and Y a closed subvariety. Moreover, it is compatible with the long exact cohomology sequence for triples $Z \subset Y \subset X$.
2. He then introduces a tensor product and establishes rigidity.

The first step is completely formal and rests firmly on representation theory. The same construction can be made for any oriented graph and any representation in a category of modules over a noetherian ring. The abstract construction of this *diagram category* is explained in Chapter 7. Note that neither the tensor product nor rigidity is needed at this point. Nevertheless, Tannaka theory is woven into proving that the diagram category has the necessary universal property: it is initial among all abelian categories over which the representation factors. Looking closely at the arguments in Chapter 7, in particular Section 7.3, we find the same arguments that are used in [DMOS82] in order to establish the existence of a Tannaka dual. In the case of a rigid tensor category, by Tannaka duality it is equal to the category of representations of an affine group scheme or equivalently co-representations of a Hopf algebra A . If we do not have rigidity, we do not have the antipodal map. We are left with a bialgebra. If we do not have a tensor product, we do not have a multiplication. We are left with a coalgebra. Indeed, the diagram category can be described as the co-representations of an explicit coalgebra, if the coefficient ring is a Dedekind ring or a field.

Chapter 8 aims at introducing a rigid tensor structure on the diagram category, or equivalently a Hopf algebra structure on the coalgebra. The product is induced by a product structure on the diagram and multiplicative representations. Rigidity is actually deduced as a property of the diagram category. Nori has a strong criterion for rigidity. Instead of asking for a unit and a counit, we only need one of the two such that it becomes a duality under the representation. This rests on the fact that an algebraic submonoid of an algebraic group is an algebraic group. The argument is analogous to showing that a submonoid of a finite abstract group is a group. Multiplication by an element is injective in these cases, because it is injective on the group. If the monoid is finite, it also has to be surjective. Everything can also be applied to the diagram defined by any Tannaka category. Hence the exposition actually contains a full proof of Tannaka duality.

The second step is of completely different nature. It uses an insight on algebraic varieties. This is the famous Basic Lemma of Nori, see Section 2.5. As it turned out, Beilinson and also Vilonen had independently found the lemma earlier. However, it was Nori who recognised its significance in these kind of motivic situations. Let us explain the problem first. We would like to define the tensor product of two motives of the form $H^n(X, Y)$ and $H^{n'}(X', Y')$. The only formula that comes to mind is

$$H^n(X, Y) \otimes H^{n'}(X', Y') = H^N(X \times X', X \times Y' \cup Y \times X')$$

with $N = n + n'$. This is, however, completely false in general. The cup product will give a map from the left to the right. By the Künneth formula, we get an isomorphism when taking the sum over all n, n' with $n + n' = N$ on the left, but not for a single summand.

Nori simply defines a pair (X, Y) to be *good* if its singular cohomology is concentrated in a single degree and, moreover, a free module. In the case of good pairs, the Künneth formula is compatible with the naive tensor product of motives. The Basic Lemma implies that the category of motives is generated by good pairs. The details are explained in Chapter 9, in particular Section 9.2.

We would like to mention an issue that was particularly puzzling to us. How is the graded commutativity of the Künneth formula dealt with in Nori's construction? This is one of the key problems in pure motives because it causes singular cohomology *not* to be compatible with the tensor structure on Chow motives. The signs can be fixed, but only after assuming the Künneth standard conjecture. Nori's construction seems to ignore this problem. So, how does it go away? The answer is the commutative diagram on page 179: the outer diagrams have signs, but luckily they cancel.

Once the category is constructed as a category, the most important property to check is rigidity. We give Nori's original proof and also explain an alternative argument using the comparison with the rigid category of Voevodsky motives. The same comparison functor also allows us to define the weight filtration motivically, see Chapter 10. As first shown by Arapura, the category of pure Nori motives turns out to be equivalent to André's category of pure motives via motivated cycles.

Cohomology theories

In Part I, we develop singular cohomology and algebraic de Rham cohomology of algebraic varieties and the period isomorphism between them in some detail.

In Chapter 2, we recall as much of the properties of singular cohomology as is needed in the sequel. We view it primarily as sheaf cohomology of the

analytic space associated to a variety over a fixed subfield k of \mathbb{C} . In addition to standard properties like Poincaré duality and the Künneth formula, we also discuss more special properties.

One such property is Nori's Basic Lemma: for a given affine variety X there is a closed subvariety Y such that relative cohomology is concentrated in a single degree. As discussed above, this is a crucial input for the construction of the tensor product on Nori motives. We give three proofs, two of them due to Nori, and an earlier one due to Beilinson.

In addition, in order to compare different possible definitions of the set of periods numbers, we need to understand triangulations of algebraic varieties by semi-algebraic simplices defined over \mathbb{Q} .

Finally, we give a description of singular cohomology in terms of a Grothendieck topology (the h' -topology) on analytic spaces which is used later in order to define the period isomorphism.

Algebraic de Rham cohomology is much less documented in the literature. Through Hodge theory, the specialists have understood for a long time what the correct definitions in the singular case are, but we are not aware of a coherent exposition of algebraic de Rham cohomology. This is what Chapter 3 provides. First we first systematically treat the more standard case of a smooth variety where de Rham cohomology is given as hypercohomology of the de Rham complex. In a second step, starting in Section 3.2, we generalise to the singular case. We choose the approach of the first author and Jörder in [HJ14] via the h -cohomology on the category of k -varieties, but also explain the relation to Deligne's approach via hypercovers and Hartshorne's approach via formal completion at the ideal of definition inside a smooth variety.

The final aim is to construct a natural isomorphism between singular cohomology and algebraic de Rham cohomology. This is established via the intermediate step of holomorphic de Rham cohomology. The comparison between singular and holomorphic de Rham cohomology comes from the Poincaré lemma: the de Rham complex is a resolution of the constant sheaf. The comparison between algebraic and holomorphic de Rham cohomology can be reduced to GAGA. This story is fairly well-known for smooth varieties. In our description with the h -topology, the singular case follows easily.

Periods

We have already discussed periods at some length at the beginning of the introduction. Roughly, a period number is the value of an integral of a differential form over some algebraically defined domain. The definition can be made for any subfield k of \mathbb{C} . There are several versions of the definition in the literature and even more folklore versions around. They fall into three classes:

1. In naive definitions the domains of integration are semi-algebraic simplices in \mathbb{R}^N , over which one integrates rational differential forms defined over k (or over \bar{k}), as long as the integral converges, see Chapter 12.
2. In more advanced versions, let X be an algebraic variety, and let $Y \subset X$ be a subvariety, both defined over k , let ω be a closed algebraic differential form on X defined over k (or a relative de Rham cohomology class), and consider the period isomorphism between de Rham and singular cohomology. Periods are the numbers appearing as entries of the period matrix. Variants include the cases where X is smooth, Y is a divisor with normal crossings, or perhaps where X is affine, and smooth outside Y , see Chapter 11.
3. In the most sophisticated versions, take your favourite category of mixed motives and consider the period isomorphism between their de Rham and singular realisation. Again, the entries of the period matrix are periods, see Chapter 6.

It is one of the main results of the present book that all these definitions agree. A direct proof of the equivalence of the different versions of cohomological periods is given in Chapter 11. A crucial ingredient of the proof is Nori's description of relative cohomology via the Basic Lemma. The comparison with periods of geometric Voevodsky motives, absolute Hodge motives and Nori motives is discussed in Chapter 6. In Chapter 12, we discuss periods as in 1. above and show that they agree with cohomological periods.

The concluding Chapter 13 explains the deeper relation between periods of Nori motives and Kontsevich's period conjecture, as already mentioned earlier in the introduction. We also discuss the period conjecture itself.

Leitfaden

Part I, II, III and IV are supposed to be somewhat independent of each other, whereas the chapters in each part depend more or less linearly on each other. In fact, Part IV may be a good starting point for reading the book or at least a good companion for the more general theory developed elsewhere.

Part I is mostly meant as a reference for facts on cohomology that we need in the development of the theory. Chapter 6 is a survey on the different notions of motives that will play a role. Most readers will skip this part and only come back to it when needed.

Part II is a self-contained introduction to the theory of Nori motives. Chapter 9 gives the actual definition. It needs the input from Chapter 2 on singular cohomology.

Part III develops the theory of period numbers. Chapter 11 on cohomological periods needs the period isomorphism of Chapter 5, and of course singular cohomology (Chapter 2) and algebraic de Rham cohomology (Chapter 3). Chapter 11 also develops the linear algebra part of the theory of

period numbers needed in the rest of Part III. Chapter 11 uses Nori motives, but should be understandable based just on the survey in Section 9.1. Chapter 12 on the alternative notion of Kontsevich–Zagier periods is mostly self-contained, with some input from Chapter 11. Finally, Chapter 13 on formal periods relies on the full force of the theory of Nori motives, in particular on the abstract results on the comparison of fibre functors in Section 8.4.

Part IV has a different flavour: Rather than developing the theory, we go through many examples of period numbers. The following picture summarises the dependencies inside the book. An arrow denotes that the previous material has a considerable effect on the chapter it is pointing to.

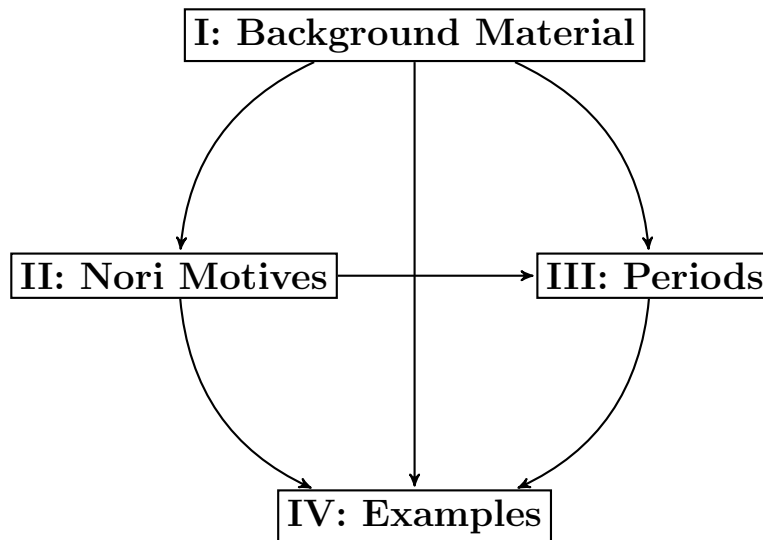

Acknowledgments

This work is fundamentally based on some unpublished work of Madhav Nori. We thank him for several conversations. The presentation of his work in this book is ours and hence, of course, all mistakes are ours.

Besides the preprint [HMS11] of the main authors, this book is built on the work of Benjamin Friedrich [Fri04] on periods and Jonas von Wangenheim [vW11] on diagram categories. We are very grateful to Benjamin Friedrich and Jonas von Wangenheim for allowing us to use their work in this book. The material of Friedrich’s preprint is contained in Section 2.6, Chapters 11, 12, 14, and also 15. The diploma thesis of Wangenheim essentially coincides with Chapter 7.

Special thanks go to Joseph Ayoub and Gisbert Wüstholz for organising with us the Alpbach Workshop “Motives, periods and transcendence” on [HMS11] and related topics in 2011. We thank all participants for their careful reading and subsequent corrections. In particular, we would like to mention Martin Gallauer, who found a severe flaw in Chapter 8 and fixed it himself.

We have benefited from discussions and comments of Kévin Francois, Martin Gallauer, Daniel Harrer, Fritz Hörmann, Peter Jossen, Stefan Kebekus, Shane Kelly, Jan Nagel, Claus Scheiderer, Duco van Straten, Konrad Völkel, and Matthias Wendt.

We are very grateful to Wolfgang Soergel for his continuous support in the Tannakian aspects of Part II. His insights greatly improved the exposition. We thank Jörg Schürmann for his patient explanations on weakly constructible sheaves in Section 2.5. We would not have been able to find all these references without him.

We thank Yves André for sharing his insights on the period conjecture and its relation to the Hodge conjecture. Chapter 10 on the relation between Nori motives and motivated cycles was added after discussions with him.

We thank Javier Fresán, Chris Peters, Thomas Weißschuh, and Matthias Wendt for their careful reading of large portions of our manuscript. We also thank all participants of the lectures on the topic held in Mainz and in Freiburg in 2014 and 2015.

Freiburg and Mainz,
November, 2016

Annette Huber
Stefan Müller-Stach

Part I
Background Material

Chapter 1

General Set-up

In this chapter we collect some standard notation used throughout the book.

1.1 Varieties

Let k be a field. It will almost always be of characteristic zero or even a subfield of \mathbb{C} .

By a *scheme* over k we mean a separated scheme of finite type over k . Let Sch be the category of k -schemes. By a *variety* over k we mean a quasi-projective reduced scheme of finite type over k . Let Var be the category of varieties over k . Let Sm and Aff be the full subcategories of smooth varieties and affine varieties, respectively.

1.1.1 Linearising the category of varieties

We also need the additive categories generated by these categories of varieties. More precisely:

Definition 1.1.1. Let $\mathbb{Z}[\text{Var}]$ be the category with objects the objects of Var . If $X = X_1 \cup \dots \cup X_n$, $Y = Y_1 \cup \dots \cup Y_m$ are varieties with connected components X_i, Y_j , we put

$$\text{Mor}_{\mathbb{Z}[\text{Var}]}(X, Y) = \bigoplus_{i=1}^n \bigoplus_{j=1}^m \left\{ \sum_k a_k f_k \mid a_k \in \mathbb{Z}, f_k \in \text{Mor}_{\text{Var}}(X_i, Y_j) \right\}$$

with the addition of formal linear combinations. Composition of morphisms is defined by extending composition of morphisms of varieties \mathbb{Z} -linearly.

Analogously, we define $\mathbb{Z}[\text{Sm}]$, $\mathbb{Z}[\text{Aff}]$ from Sm and Aff . Moreover, let $\mathbb{Q}[\text{Var}]$, $\mathbb{Q}[\text{Sm}]$ and $\mathbb{Q}[\text{Aff}]$ be the analogous \mathbb{Q} -linear additive categories where the morphisms are formal \mathbb{Q} -linear combinations of morphisms of varieties.

Let $F = \sum a_k f_k : X \rightarrow Y$ be a morphism in $\mathbb{Z}[\text{Var}]$. The *support* of F is the set of f_k with $a_k \neq 0$.

$\mathbb{Z}[\text{Var}]$ is an additive category with direct sum given by the disjoint union of varieties. The zero object corresponds to the empty variety (which does not have any connected components).

We will also need the category of *smooth correspondences* SmCor . It has the same objects as Sm and as morphisms *finite correspondences* (see also Definition 6.2.1)

$$\text{Mor}_{\text{SmCor}}(X, Y) = \text{Cor}(X, Y),$$

where $\text{Cor}(X, Y)$ is the free \mathbb{Z} -module with generators integral subschemes $\Gamma \subset X \times Y$ such that $\Gamma \rightarrow X$ is finite and dominant over a component of X . Sometimes, we use $\text{SmCor}_{\mathbb{Q}}$ with the same objects but with morphisms tensored by \mathbb{Q} , i.e., \mathbb{Q} -linear combinations of finite correspondences.

Remark 1.1.2. $\mathbb{Z}[\text{Var}]$ satisfies a universal property with respect to functors $F : \text{Var} \rightarrow \mathcal{A}$ into additive categories such that disjoint unions are mapped to direct sums.

1.1.2 Divisors with normal crossings

Definition 1.1.3. Let X be a smooth variety of dimension n and $D \subset X$ a closed subvariety of codimension 1. The subvariety D is called a *divisor with normal crossings* if for every point of D there is an affine neighbourhood U of x in X which is étale over \mathbb{A}^n via coordinates t_1, \dots, t_n and such that $D|_U$ has the form

$$D|_U = V(t_1 t_2 \cdots t_r)$$

for some $1 \leq r \leq n$.

D is called a *divisor with simple normal crossings* if in addition the irreducible components of D are smooth.

In other words, D looks étale locally like an intersection of coordinate hyperplanes.

Example 1.1.4. Let $D \subset \mathbb{A}^2$ be the nodal curve given by the equation $y^2 = x^2(x - 1)$. It is smooth at all points different from $(0, 0)$ and looks étale locally like $xy = 0$ near the origin. Hence it is a divisor with normal crossings but not a simple normal crossings divisor.

1.2 Complex analytic spaces

A classical reference for complex analytic spaces is the book of Grauert and Remmert [GR77].

Definition 1.2.1. A *complex analytic space* is a locally ringed space $(X, \mathcal{O}_X^{\text{hol}})$ with X paracompact and Hausdorff, and such that $(X, \mathcal{O}_X^{\text{hol}})$ is locally isomorphic to the vanishing locus Z of a set S of holomorphic functions in some open $U \subset \mathbb{C}^n$ and $\mathcal{O}_Z^{\text{hol}} = \mathcal{O}_U^{\text{hol}} / \langle S \rangle$, where $\mathcal{O}_U^{\text{hol}}$ is the sheaf of holomorphic functions on U .

A *morphism* of complex analytic spaces is a morphism $f : (X, \mathcal{O}_X^{\text{hol}}) \rightarrow (Y, \mathcal{O}_Y^{\text{hol}})$ of locally ringed spaces, which is given by a morphism of sheaves $f^\# : \mathcal{O}_Y^{\text{hol}} \rightarrow f_* \mathcal{O}_X^{\text{hol}}$ that sends a germ $h \in \mathcal{O}_{Y,y}^{\text{hol}}$ of a holomorphic function h near y to the germs $h \circ f$, which are holomorphic near x for all x with $f(x) = y$. A morphism will sometimes simply be called a holomorphic map, and will be denoted in short form as $f : X \rightarrow Y$.

Let An be the category of complex analytic spaces.

Example 1.2.2. Let X be a complex manifold. Then it can be viewed as a complex analytic space. The structure sheaf is defined via the charts.

Definition 1.2.3. A morphism $X \rightarrow Y$ between complex analytic spaces is called *proper* if the preimage of any compact subset in Y is compact.

1.2.1 Analytification

Polynomials over \mathbb{C} can be viewed as holomorphic functions. Hence an affine variety X immediately defines a complex analytic space X^{an} . If X is smooth, X^{an} is even a complex manifold. This assignment is well-behaved under gluing and hence it globalises. A general reference for this is [Gro71], exposé XII by M. Raynaud.

Proposition 1.2.4. *There is a functor*

$$(\cdot)^{\text{an}} : \text{Sch}_{\mathbb{C}} \rightarrow \text{An}$$

which assigns to a scheme of finite type over \mathbb{C} its analytification. There is a natural morphism of locally ringed spaces

$$\alpha : (X^{\text{an}}, \mathcal{O}_{X^{\text{an}}}^{\text{hol}}) \rightarrow (X, \mathcal{O}_X)$$

and $(\cdot)^{\text{an}}$ is universal with this property. Moreover, α is the identity on closed points.

If X is smooth, then X^{an} is a complex manifold. If $f : X \rightarrow Y$ is proper, then so is f^{an} .

Proof. By the universal property it suffices to consider the affine case where the obvious construction works. Note that X^{an} is Hausdorff because X is separated, and it is paracompact because it has a finite cover by closed subsets of some \mathbb{C}^n . If X is smooth, then X^{an} is smooth by [Gro71], Prop. 2.1 in exposé XII, or simply by the Jacobi criterion. The fact that f^{an} is proper if f is proper is shown in [Gro71], Prop. 3.2 in exposé XII. \square

1.3 Complexes

1.3.1 Basic definitions

Let \mathcal{A} be an additive category. Unless specified otherwise, a *complex* will always mean a cohomological complex, i.e., a sequence A^i for $i \in \mathbb{Z}$ of objects of \mathcal{A} with ascending differential $d^i : A^i \rightarrow A^{i+1}$ such that $d^{i+1} \circ d^i = 0$ for all $i \in \mathbb{Z}$. The category of complexes is denoted by $C(\mathcal{A})$. We write $C^+(\mathcal{A})$, $C^-(\mathcal{A})$ and $C^b(\mathcal{A})$ for the full subcategories of complexes bounded below, bounded above and bounded, respectively.

If $K^\bullet \in C(\mathcal{A})$ is a complex, we define the *shifted complex* $K^\bullet[1]$ with

$$(K^\bullet[1])^i = K^{i+1}, \quad d_{K^\bullet[1]}^i = -d_{K^\bullet}^{i+1}.$$

If $f : K^\bullet \rightarrow L^\bullet$ is a morphism of complexes, its *cone* is the complex $\text{Cone}(f)^\bullet$ with

$$\text{Cone}(f)^i = K^{i+1} \oplus L^i, \quad d_{\text{Cone}(f)}^i = (-d_K^{i+1}, f^{i+1} + d_L^i).$$

By construction there are morphisms

$$L^\bullet \rightarrow \text{Cone}(f) \rightarrow K^\bullet[1].$$

Let $K(\mathcal{A})$, $K^+(\mathcal{A})$, $K^-(\mathcal{A})$ and $K^b(\mathcal{A})$ be the corresponding homotopy categories where the objects are the same and the morphisms are homotopy classes of morphisms of complexes. Note that these categories are always triangulated with the above shift functor and the class of distinguished triangles are those homotopy equivalent to

$$K^\bullet \xrightarrow{f} L^\bullet \rightarrow \text{Cone}(f) \rightarrow K^\bullet[1]$$

for some morphism of complexes f . Now recall:

Definition 1.3.1. Let \mathcal{A} be an abelian category. A morphism $f^\bullet : K^\bullet \rightarrow L^\bullet$ of complexes in \mathcal{A} is called a *quasi-isomorphism* if

$$H^i(f) : H^i(K^\bullet) \rightarrow H^i(L^\bullet)$$

is an isomorphism for all $i \in \mathbb{Z}$.

We will always assume that an abelian category has enough injectives, or is essentially small, in order to avoid set-theoretic problems. If \mathcal{A} is abelian, let $D(\mathcal{A})$, $D^+(\mathcal{A})$, $D^-(\mathcal{A})$ and $D^b(\mathcal{A})$ be the induced *derived categories* where the objects are the same as in $K^?(\mathcal{A})$ and morphisms are obtained by localising $K^?(\mathcal{A})$ with respect to the class of quasi-isomorphisms. A triangle is *distinguished* if it is isomorphic in $D^?(\mathcal{A})$ to a distinguished triangle in $K^?(\mathcal{A})$.

Example 1.3.2. Let \mathcal{A} be abelian. If $f : K^\bullet \rightarrow L^\bullet$ is a morphism of complexes, then

$$0 \rightarrow L^\bullet \rightarrow \text{Cone}(f) \rightarrow K^\bullet[1] \rightarrow 0$$

is an exact sequence of complexes. Indeed, it is degreewise split-exact.

1.3.2 Filtrations

Filtrations on complexes are used in order to construct spectral sequences. We mostly need two standard cases.

Definition 1.3.3. Let \mathcal{A} be an additive category, K^\bullet a complex in \mathcal{A} .

1. The *trivial filtration* (“*filtration bête*” in the French literature) $F^{\geq p}K^\bullet$ on K^\bullet is given by

$$F^{\geq p}K^\bullet = \begin{cases} K^i & i \geq p, \\ 0 & i < p. \end{cases}$$

The quotient $K^\bullet/F^{\geq p}K^\bullet$ is given by

$$F^{< p}K^\bullet = \begin{cases} 0 & i \geq p, \\ K^i & i < p. \end{cases}$$

2. The *canonical filtration* $\tau_{\leq p}K^\bullet$ on K^\bullet is given by

$$\tau_{\leq p}K^\bullet = \begin{cases} K^i & i < p, \\ \text{Ker}(d^p) & i = p, \\ 0 & i > p. \end{cases}$$

The quotient $K^\bullet/\tau_{\leq p}K^\bullet$ is given by

$$\tau_{> p}K^\bullet = \begin{cases} 0 & i < p, \\ K^p/\text{Ker}(d^p) & i = p, \\ K^i & i > p. \end{cases}$$

The associated graded pieces of the trivial filtration are given by

$$F^{\geq p}K^\bullet / F^{\geq p+1}K^\bullet = K^p.$$

The associated graded pieces of the canonical filtration are given by

$$\tau_{\leq p}K^\bullet / \tau_{\leq p-1}K^\bullet = H^p(K^\bullet).$$

1.3.3 Total complexes and signs

We return to the more general case of an additive category \mathcal{A} . We consider double complexes $K^{\bullet, \bullet} \in C(\mathcal{A})$, i.e., double complexes consisting of a set of objects $K^{i,j} \in \mathcal{A}$ for $i, j \in \mathbb{Z}$ with differentials

$$d_1^{i,j} : K^{i,j} \rightarrow K^{i,j+1}, \quad d_2^{i,j} : K^{i,j} \rightarrow K^{i+1,j}$$

such that $(K^{i, \bullet}, d_2^{i, \bullet})$ and $(K^{\bullet, j}, d_1^{\bullet, j})$ are complexes and the diagrams

$$\begin{array}{ccc} K^{i,j+1} & \xrightarrow{d_2^{i,j+1}} & K^{i+1,j+1} \\ d_1^{i,j} \uparrow & & \uparrow d_1^{i+1,j} \\ K^{i,j} & \xrightarrow{d_2^{i,j}} & K^{i+1,j} \end{array}$$

commute for all $i, j \in \mathbb{Z}$. The *associated simple complex* or *total complex* $\text{Tot}(K^{\bullet, \bullet})$ is defined as

$$\text{Tot}(K^{\bullet, \bullet})^n = \bigoplus_{i+j=n} K^{i,j}, \quad d_{\text{Tot}(K^{\bullet, \bullet})}^n = \sum_{i+j=n} (d_1^{i,j} + (-1)^j d_2^{i,j}).$$

In order to take the direct sum, either the category has to allow infinite direct sums or we have to assume boundedness conditions to make sure that only finite direct sums occur. This is the case if $K^{i,j} = 0$ unless $i, j \geq 0$.

Examples 1.3.4. 1. Our definition of the cone is a special case: for $f : K^\bullet \rightarrow L^\bullet$

$$\text{Cone}(f) = \text{Tot}(\tilde{K}^{\bullet, \bullet}), \quad \tilde{K}^{\bullet, -1} = K^\bullet, \tilde{K}^{\bullet, 0} = L^\bullet, d_1^{i, -1} = f^i.$$

2. Another example is given by the tensor product. Given two complexes (F^\bullet, d_F) and (G^\bullet, d_G) of R -modules for some commutative ring R , the tensor product

$$(F^\bullet \otimes G^\bullet)^n = \bigoplus_{i+j=n} F^i \otimes G^j$$

has a natural structure of a double complex with $K^{i,j} = F^i \otimes G^j$, and the differential is given by $d = \text{id}_F \otimes d_G + (-1)^i d_F \otimes \text{id}_G$.

Remark 1.3.5. There is a choice of signs in the definition of the total complex. See, for example, [Hub95, §2.2] for a discussion. We use the convention opposite to the one of loc. cit. For most formulae it does not matter which choice is used, as long as it is used consistently. However, it does have an asymmetric effect on the formula for the compatibility of cup-products with boundary maps. We spell out the source of this asymmetry.

Lemma 1.3.6. *Let F^\bullet, G^\bullet be complexes in an additive tensor category. Then:*

1. $F^\bullet \otimes (G^\bullet[1]) = (F^\bullet \otimes G^\bullet)[1]$.
2. $\epsilon : (F^\bullet[1]) \otimes G^\bullet \rightarrow (F^\bullet \otimes G^\bullet)[1]$ with $\epsilon = (-1)^j$ on $F^i \otimes G^j$ (in degree $i + j - 1$) is an isomorphism of complexes.

Proof. We compute the differential on $F^i \otimes G^j$ in all three complexes. Note that

$$F^i \otimes G^j = (F[1])^{i-1} \otimes G^j = F^i \otimes (G[1])^{j-1}.$$

For better readability, we drop $\otimes \text{id}$, $\text{id} \otimes$ and $|_{F^i \otimes G^j}$ everywhere. Hence we have

$$\begin{aligned} d_{(F^\bullet \otimes G^\bullet)[1]}^{i+j-1} &= -d_{F^\bullet \otimes G^\bullet}^{i+j} \\ &= -\left(d_{G^\bullet}^j + (-1)^j d_{F^\bullet}^i\right) \\ &= -d_{G^\bullet}^j + (-1)^{j-1} d_{F^\bullet}^i \\ d_{F^\bullet \otimes (G^\bullet[1])}^{i+j-1} &= d_{G^\bullet[1]}^{j-1} + (-1)^{j-1} d_{F^\bullet}^i \\ &= -d_{G^\bullet}^j + (-1)^{j-1} d_{F^\bullet}^i \\ d_{(F^\bullet[1]) \otimes G^\bullet}^{i+j-1} &= d_{G^\bullet}^j + (-1)^j d_{F^\bullet[1]}^{i-1} \\ &= d_{G^\bullet}^j + (-1)^{j-1} d_{F^\bullet}^i \end{aligned}$$

We see that the first two complexes agree, whereas the differential of the third is different. Multiplication by $(-1)^j$ on the summand $F^i \otimes G^j$ is a morphism of complexes. \square

1.4 Hypercohomology

Let X be a topological space and $\text{Sh}(X)$ the abelian category of sheaves of abelian groups on X .

We want to extend the definition of sheaf cohomology on X , as explained in [Har77, Chapter III], to complexes of sheaves.

1.4.1 Definition

Definition 1.4.1. Let \mathcal{F}^\bullet be a bounded below complex of sheaves of abelian groups on X . An *injective resolution* of \mathcal{F}^\bullet is a quasi-isomorphism

$$\mathcal{F}^\bullet \rightarrow \mathcal{I}^\bullet$$

where \mathcal{I}^\bullet is a bounded below complex with \mathcal{I}^n *injective* for all n , i.e., $\text{Hom}(-, \mathcal{I}^n)$ is exact.

Sheaf cohomology of X with coefficients in \mathcal{F}^\bullet is defined as

$$H^i(X, \mathcal{F}^\bullet) = H^i(\Gamma(X, \mathcal{I}^\bullet)) \quad i \in \mathbb{Z}$$

where $\mathcal{F}^\bullet \rightarrow \mathcal{I}^\bullet$ is an injective resolution.

Remark 1.4.2. In the older literature, it is customary to write $\mathbb{H}^i(X, \mathcal{F}^\bullet)$ instead of $H^i(X, \mathcal{F}^\bullet)$ and call it *hypercohomology*. We do not see any need for this. Note that in the special case $\mathcal{F}^\bullet = \mathcal{F}[0]$ of a sheaf viewed as a complex concentrated in degree 0, the notion of an injective resolution in the above sense agrees with the ordinary one in homological algebra.

Remark 1.4.3. In the language of derived categories, we have

$$H^i(X, \mathcal{F}^\bullet) = \text{Hom}_{D^+(\text{Sh}(X))}(\mathbb{Z}, \mathcal{F}^\bullet[i])$$

because $\Gamma(X, \cdot) = \text{Hom}_{\text{Sh}(X)}(\mathbb{Z}, \cdot)$.

Lemma 1.4.4. $H^i(X, \mathcal{F}^\bullet)$ is well-defined and functorial in \mathcal{F}^\bullet .

Proof. We first need the existence of injective resolutions. Recall that the category $\text{Sh}(X)$ has enough injectives. Hence every sheaf has an injective resolution. This extends to bounded below complexes in \mathcal{A} by [Wei94, Lemma 5.7.2] (or rather, its analogue for injective rather than projective objects).

Let $\mathcal{F}^\bullet \rightarrow \mathcal{I}^\bullet$ and $\mathcal{G}^\bullet \rightarrow \mathcal{J}^\bullet$ be injective resolutions. By loc. cit. Theorem 10.4.8,

$$\text{Hom}_{D^+(\text{Sh}(X))}(\mathcal{F}^\bullet, \mathcal{G}^\bullet) = \text{Hom}_{K^+(\text{Sh}(X))}(\mathcal{I}^\bullet, \mathcal{J}^\bullet).$$

This means in particular that every morphism of complexes lifts to a morphism of injective resolutions and that the lift is unique up to homotopy of complexes. Hence the induced maps

$$H^i(\Gamma(X, \mathcal{I}^\bullet)) \rightarrow H^i(\Gamma(X, \mathcal{J}^\bullet))$$

agree. This implies that $H^i(X, \mathcal{F}^\bullet)$ is well-defined and a functor. \square

Remark 1.4.5. Injective sheaves are abundant (by our general assumption that there are enough injectives), but not suitable for computations. Every injective sheaf \mathcal{F} is *flasque* [Har75, III. Lemma 2.4], i.e., the restriction maps

$\mathcal{F}(U) \rightarrow \mathcal{F}(V)$ between non-empty open sets $V \subset U$ are always surjective. Below we will introduce the canonical flasque Godement resolution for any sheaf \mathcal{F} . More generally, every flasque sheaf \mathcal{F} is *acyclic*, i.e., $H^i(X, \mathcal{F}) = 0$ for $i > 0$. One may compute sheaf cohomology of \mathcal{F} using any acyclic resolution F^\bullet . This follows from the hypercohomology spectral sequence

$$E_2^{p,q} = H^p(H^q(F^\bullet)) \Rightarrow H^{p+q}(X, \mathcal{F})$$

which is supported entirely on the line $q = 0$.

Special acyclic resolutions on X are the so-called *fine resolutions*. See [War83, p. 170] for a definition of fine sheaves involving partitions of unity. Their importance comes from the fact that sheaves of \mathcal{C}^∞ -functions and sheaves of \mathcal{C}^∞ -differential forms on X are fine sheaves.

1.4.2 Godement resolutions

For many purposes, it is useful to have functorial resolutions of sheaves. One such is given by the *Godement resolution*, introduced in [God58, Chapter II, §3].

Let X be a topological space. Recall that a sheaf on X vanishes if and only if the stalks at all $x \in X$ vanish. For all $x \in X$ we denote by $i_x : x \rightarrow X$ the natural inclusion.

Definition 1.4.6. Let $\mathcal{F} \in \text{Sh}(X)$. Put

$$I(\mathcal{F}) = \prod_{x \in X} i_{x*} \mathcal{F}_x.$$

Inductively, we define the Godement resolution $Gd^\bullet(\mathcal{F})$ of \mathcal{F} by

$$\begin{aligned} Gd^0(\mathcal{F}) &= I(\mathcal{F}), \\ Gd^1(\mathcal{F}) &= I(\text{Coker}(\mathcal{F} \rightarrow Gd^0(\mathcal{F}))), \\ Gd^{n+1}(\mathcal{F}) &= I(\text{Coker}(Gd^{n-1}(\mathcal{F}) \rightarrow Gd^n(\mathcal{F}))) \quad n > 0. \end{aligned}$$

Lemma 1.4.7. 1. Gd^\bullet is an exact functor with values in $C^+(\text{Sh}(X))$.
2. The natural map $\mathcal{F} \rightarrow Gd^\bullet(\mathcal{F})$ is a flasque resolution.

Proof. Functoriality is obvious. The sheaf $I(\mathcal{F})$ is given by

$$U \mapsto \prod_{x \in U} i_{x*} \mathcal{F}_x.$$

All the sheaves involved are flasque, hence acyclic. In particular, taking direct products is exact (it is not in general), turning $I(\mathcal{F})$ into an exact functor.

$\mathcal{F} \rightarrow I(\mathcal{F})$ is injective, and hence by construction, $Gd^\bullet(\mathcal{F})$ is then a flasque resolution. \square

We extend this to a functor on complexes:

Definition 1.4.8. Let $\mathcal{F}^\bullet \in C^+(\text{Sh}(X))$ be a complex of sheaves. We call

$$Gd(\mathcal{F}^\bullet) := \text{Tot}(Gd^\bullet(\mathcal{F}^\bullet))$$

the *Godement resolution* of \mathcal{F}^\bullet .

Corollary 1.4.9. *The natural map*

$$\mathcal{F}^\bullet \rightarrow Gd(\mathcal{F}^\bullet)$$

is a quasi-isomorphism and

$$H^i(X, \mathcal{F}^\bullet) = H^i(\Gamma(X, Gd(\mathcal{F}^\bullet))).$$

Proof. By Lemma 1.4.7, the first assertion holds if \mathcal{F}^\bullet is concentrated in a single degree. The general case follows by the hypercohomology spectral sequence or by induction on the length of the complex using the trivial filtration.

All terms in $Gd(\mathcal{F}^\bullet)$ are flasque, hence acyclic for $\Gamma(X, \cdot)$. \square

We now study functoriality of the Godement resolution. For a continuous map $f : X \rightarrow Y$ we denote by f^{-1} the pull-back functor on sheaves of abelian groups. Recall that it is exact.

Lemma 1.4.10. *Let $f : X \rightarrow Y$ be a continuous map between topological spaces and $\mathcal{F}^\bullet \in C^+(\text{Sh}(Y))$. Then there is a natural quasi-isomorphism*

$$f^{-1}Gd_Y(\mathcal{F}^\bullet) \rightarrow Gd_X(f^{-1}\mathcal{F}^\bullet).$$

Proof. First consider a single sheaf \mathcal{F} on Y . We want to construct

$$f^{-1}I(\mathcal{F}) \rightarrow I(f^{-1}\mathcal{F}) = \prod_{x \in X} i_{x*}(f^{-1}\mathcal{F})_x = \prod_{x \in X} i_{x*}\mathcal{F}_{f(x)}.$$

By the universal property of the direct product and adjunction for f^{-1} , this is equivalent to specifying for all $x \in X$

$$\prod_{y \in Y} i_{y*}\mathcal{F}_y = I(\mathcal{F}) \rightarrow f_*i_{x*}\mathcal{F}_{f(x)} = i_{f(x)*}\mathcal{F}_{f(x)}.$$

For this, we use the natural projection map. By construction, we have a natural commutative diagram

$$\begin{array}{ccccc}
f^{-1}\mathcal{F} & \longrightarrow & f^{-1}I(\mathcal{F}) & \longrightarrow & \text{Coker}(f^{-1}\mathcal{F} \rightarrow f^{-1}I(\mathcal{F})) \\
\parallel & & \downarrow & & \\
f^{-1}\mathcal{F} & \longrightarrow & I(f^{-1}\mathcal{F}) & \longrightarrow & \text{Coker}(f^{-1}\mathcal{F} \rightarrow I(f^{-1}\mathcal{F})).
\end{array}$$

It induces a map between the cokernels. Proceeding inductively, we obtain a morphism of complexes

$$f^{-1}Gd_Y^\bullet(\mathcal{F}) \rightarrow Gd_X^\bullet(f^{-1}\mathcal{F}).$$

It is a quasi-isomorphism because both are resolutions of $f^{-1}\mathcal{F}$. This transformation of functors extends to double complexes and hence defines a transformation of functors on $C^+(\text{Sh}(Y))$. \square

Remark 1.4.11. We are going to apply the theory of Godement resolutions in the case where X is a variety over a field k , a complex manifold or more generally a complex analytic space. The continuous maps that we need to consider are those in these categories, but also the maps of schemes $X_K \rightarrow X_k$ for the change of base field K/k and a variety over k ; and the continuous map $X^{\text{an}} \rightarrow X$ for an algebraic variety over \mathbb{C} and its analytification.

1.4.3 Čech cohomology

Neither the definition of sheaf cohomology via injective resolutions nor Godement resolutions are convenient for concrete computations. We introduce Čech cohomology for this task. We follow [Har77, Chapter III, §4], but extend to hypercohomology.

Let k be a field. We work in the category of varieties over k . Let $I = \{1, \dots, n\}$ as an ordered set and $\mathfrak{U} = \{U_i | i \in I\}$ an affine open cover of X indexed by I . For any subset $J \subset \{1, \dots, n\}$ we define

$$U_J := \bigcap_{j \in J} U_j.$$

As X is separated, these intersections are all affine.

Definition 1.4.12. Let X and \mathfrak{U} be as above. Let $\mathcal{F} \in \text{Sh}(X)$. We define the Čech complex of \mathcal{F} as

$$C^p(\mathfrak{U}, \mathcal{F}) = \prod_{J \subset I, |J|=p+1} \mathcal{F}(U_J), \quad p \geq 0$$

with differential $\delta^p : C^p(\mathfrak{U}, \mathcal{F}) \rightarrow C^{p+1}(\mathfrak{U}, \mathcal{F})$ given by

$$(\delta^p \alpha)_{(i_0, i_1, \dots, i_p)} = \sum_{j=0}^{p+1} (-1)^j \alpha_{(i_0, \dots, \hat{i}_j, \dots, i_{p+1})} |_{U_{i_0 \dots \hat{i}_j \dots i_{p+1}}},$$

where, as usual, $(i_0, \dots, \hat{i}_j, \dots, i_{p+1})$ means the tuple with i_j removed.

We define the p -th Čech cohomology of X with coefficients in \mathcal{F} as

$$\check{H}^p(\mathfrak{U}, \mathcal{F}) = H^p(C^\bullet(\mathfrak{U}, \mathcal{F}), \delta).$$

Remark 1.4.13. In the literature, we often find the version where only strictly ordered tuples are used. The two complexes are homotopy equivalent. The full complex has better functorial properties because it does not depend on an ordering of the indices. On the other hand, the restricted complex has the advantage of being bounded for finite index sets.

Proposition 1.4.14 ([Har77, Chapter III, Theorem 4.5]). *Let X be a variety and \mathfrak{U} be an affine open cover as before. Let \mathcal{F} be a coherent sheaf of \mathcal{O}_X -modules on X . Then there is a natural isomorphism*

$$H^p(X, \mathcal{F}) = \check{H}^p(\mathfrak{U}, \mathcal{F}).$$

We now extend to complexes. We can apply the functor $C^\bullet(\mathfrak{U}, \cdot)$ to all terms in a complex \mathcal{F}^\bullet and obtain a double complex $C^\bullet(\mathfrak{U}, \mathcal{F}^\bullet)$.

Definition 1.4.15. Let X and \mathfrak{U} be as before. Let $\mathcal{F}^\bullet \in C^+(\text{Sh}(X))$. We define the Čech complex of \mathfrak{U} with coefficients in \mathcal{F}^\bullet as

$$C^\bullet(\mathfrak{U}, \mathcal{F}^\bullet) = \text{Tot}(C^\bullet(\mathfrak{U}, \mathcal{F}^\bullet)),$$

and Čech cohomology as

$$\check{H}^p(\mathfrak{U}, \mathcal{F}^\bullet) = H^p(C^\bullet(\mathfrak{U}, \mathcal{F}^\bullet)).$$

Proposition 1.4.16. *Let X be a variety and \mathfrak{U} be, as before, an open affine cover of X . Let $\mathcal{F}^\bullet \in C^+(\text{Sh}(X))$ be a complex such that all \mathcal{F}^n are coherent sheaves of \mathcal{O}_X -modules. Then there is a natural isomorphism*

$$H^p(X, \mathcal{F}^\bullet) = \check{H}^p(\mathfrak{U}, \mathcal{F}^\bullet).$$

Proof. The essential step is to define the map. We first consider a single sheaf \mathcal{G} . Let $C^\bullet(\mathfrak{U}, \mathcal{G})$ be a sheafified version of the Čech complex for a sheaf \mathcal{G} . By [Har77, Chapter III, Lemma 4.2], it is a resolution of \mathcal{G} . We apply the Godement resolution and obtain a flasque resolution of \mathcal{G} by

$$\mathcal{G} \rightarrow C^\bullet(\mathfrak{U}, \mathcal{G}) \rightarrow Gd(C^\bullet(\mathfrak{U}, \mathcal{G})).$$

By Proposition 1.4.14, the induced map

$$C^\bullet(\mathfrak{U}, \mathcal{G}) \rightarrow \Gamma(X, Gd(C^\bullet(\mathfrak{U}, \mathcal{G})))$$

is a quasi-isomorphism as both sides compute $H^i(X, \mathcal{G})$.

The construction is functorial in \mathcal{G} , hence we can apply it to all components of a complex \mathcal{F}^\bullet and obtain double complexes. We use the previous results for all \mathcal{F}^n and take total complexes. Hence

$$\mathcal{F}^\bullet \rightarrow \text{Tot} \mathcal{C}^\bullet(\mathfrak{U}, \mathcal{F}^\bullet) \rightarrow \text{Gd}(\mathcal{C}^\bullet(\mathfrak{U}, \mathcal{F}^\bullet))$$

are quasi-isomorphisms. Taking global sections we get a quasi-isomorphism

$$\text{Tot} \mathcal{C}^\bullet(\mathfrak{U}, \mathcal{F}^\bullet) \rightarrow \text{Tot} \Gamma(X, \text{Gd}(\mathcal{C}^\bullet(\mathfrak{U}, \mathcal{F}^\bullet))).$$

By definition, the complex on the left computes Čech cohomology of \mathcal{F}^\bullet and the complex on the right computes hypercohomology of \mathcal{F}^\bullet . \square

Corollary 1.4.17. *Let X be an affine variety and $\mathcal{F}^\bullet \in C^+(\text{Sh}(X))$ such that all \mathcal{F}^n are coherent sheaves of \mathcal{O}_X -modules. Then*

$$H^i(\Gamma(X, \mathcal{F}^\bullet)) = H^i(X, \mathcal{F}^\bullet).$$

Proof. We use the affine covering $\mathfrak{U} = \{X\}$ and apply Proposition 1.4.16. \square

1.5 Simplicial objects

We introduce simplicial varieties in order to carry out some of the constructions in [Del74b]. Good general references on the topic are [May67] or [Wei94, Chapter 8].

Definition 1.5.1. Let Δ be the category whose objects are finite ordered sets

$$[n] = \{0, 1, \dots, n\} \quad n \in \mathbb{N}_0$$

with morphisms non-decreasing monotone maps. Let Δ_N be the full subcategory with objects the $[n]$ with $n \leq N$.

If \mathcal{C} is a category, we denote by \mathcal{C}^Δ the *category of simplicial objects* in \mathcal{C} defined as contravariant functors

$$X_\bullet : \Delta \rightarrow \mathcal{C}$$

with transformation of functors as morphisms. We denote by $\mathcal{C}^{\Delta^\circ}$ the *category of cosimplicial objects* in \mathcal{C} defined as covariant functors

$$X^\bullet : \Delta \rightarrow \mathcal{C}.$$

Similarly, we define the categories \mathcal{C}^{Δ_N} and $\mathcal{C}^{\Delta_N^\circ}$ of *N -truncated simplicial and cosimplicial objects*.

Example 1.5.2. Let X be an object of \mathcal{C} . The constant functor

$$\Delta^\circ \rightarrow \mathcal{C}$$

which maps all objects to X and all morphism to the identity morphism is a simplicial object. It is called the *constant simplicial object* associated to X .

In Δ , we have in particular the *face maps*

$$\epsilon_i : [n-1] \rightarrow [n] \quad i = 0, \dots, n,$$

the unique injective map leaving out the index i , and the *degeneracy maps*

$$\eta_i : [n+1] \rightarrow [n] \quad i = 0, \dots, n,$$

the unique surjective map with two elements mapping to i . More generally, a map in Δ is called *face* or *degeneracy* if it is a composition of ϵ_i 's or η_i 's, respectively. Any morphism in Δ can be decomposed into a degeneracy followed by a face ([Wei94, Lemma 8.12]).

For all $m \geq n$, we denote by $S_{m,n}$ the set of all degeneracy maps $[m] \rightarrow [n]$.

A simplicial object X_\bullet is determined by a sequence of objects

$$X_0, X_1, \dots$$

and face and degeneracy morphisms between them. In particular, we write

$$\partial_i : X_n \rightarrow X_{n-1}$$

for the image of ϵ_i and

$$s_i : X_n \rightarrow X_{n+1}$$

for the image of η_i .

Example 1.5.3. For every n , there is a simplicial set $\Delta[n]$ with

$$\Delta[n]_m = \text{Mor}_\Delta([n], [m])$$

and the natural face and degeneracy maps. It is called the *simplicial n -simplex*. For $n = 0$, this is the *simplicial point*, and for $n = 1$ the *simplicial interval*. Functoriality in the first argument induces maps of simplicial sets. In particular, there are

$$\delta_0 = \epsilon_0^*, \delta_1 = \epsilon_1^* : \Delta[1] \rightarrow \Delta[0].$$

Definition 1.5.4. Let \mathcal{C} be a category with finite products and coproducts. Let X_\bullet, Y_\bullet be simplicial objects in \mathcal{C} and S_\bullet a simplicial set

1. $X_\bullet \times Y_\bullet$ is the simplicial object with

$$(X_\bullet \times Y_\bullet)_n = X_n \times Y_n$$

with face and degeneracy maps induced from X_\bullet and Y_\bullet .

2. $X_\bullet \times S_\bullet$ is the simplicial object with

$$(X_\bullet \times S_\bullet)_n = \prod_{s \in S_n} X_n$$

with face and degeneracy maps induced from X_\bullet and S_\bullet .

3. Let $f, g : X_\bullet \rightarrow Y_\bullet$ be morphisms of simplicial objects. Then f is said to be *homotopic* to g if there is a morphism

$$h : X_\bullet \times \Delta[1] \rightarrow Y_\bullet$$

such that $h \circ \delta_0 = f$ and $h \circ \delta_1 = g$.

The inclusion $\Delta_N \rightarrow \Delta$ induces a natural restriction functor

$$\text{sq}_N : \mathcal{C}^\Delta \rightarrow \mathcal{C}^{\Delta_N}.$$

For a simplicial object X_\bullet , we call $\text{sq}_N X_\bullet$ its *N-skeleton*. If Y_\bullet is a fixed simplicial object, we also denote by sq_N the restriction functor from the category $\mathcal{C}^\Delta/Y_\bullet$ of simplicial objects over Y_\bullet to the category $\mathcal{C}^{\Delta_N}/\text{sq}_N Y_\bullet$ of truncated simplicial objects over $\text{sq}_N Y_\bullet$.

Remark 1.5.5. The skeleta $\text{sq}_k X_\bullet$ define the *skeletal filtration*, i.e., a chain of maps

$$\text{sq}_0 X_\bullet \rightarrow \text{sq}_1 X_\bullet \rightarrow \cdots \rightarrow \text{sq}_N X_\bullet = X_\bullet.$$

Later, in Section 2.3, we will define the topological realisation $|X_\bullet|$ of a simplicial set X_\bullet . The skeletal filtration then defines a filtration of $|X_\bullet|$ by closed subspaces.

An important example in this book is the case when the simplicial set X_\bullet is a finite set, i.e., all X_n are finite sets, and completely degenerate for $n > N$ sufficiently large. See Section 2.3.

Lemma 1.5.6. *Let \mathcal{C} be a category with finite limits. Then the functor sq_N has a right adjoint*

$$\text{cosq}_N : \mathcal{C}^{\Delta_N} \rightarrow \mathcal{C}^\Delta.$$

If Y_\bullet is a fixed simplicial object, then

$$\text{cosq}_N^{Y_\bullet}(X_\bullet) = \text{cosq}_N X_\bullet \times_{\text{cosq}_N \text{sq}_N Y_\bullet} Y_\bullet$$

is the right adjoint of the relative version of sq_N .

Proof. The existence of cosq_N is an instance of a Kan extension. We refer to [Mac71, Chapter X] or [AM69, Chapter 2] for its existence. The relative case follows from the universal properties of fibre products. \square

If X_\bullet is an N -truncated simplicial object, we call $\text{cosq}_N X_\bullet$ its *coskeleton*.

Remark 1.5.7. We apply this in particular to the case where \mathcal{C} is one of the categories Var , Sm or Aff over a fixed field k . The disjoint union of varieties is a coproduct in these categories and the direct product a product.

Definition 1.5.8. Let S be a class of maps of varieties containing all identity morphisms. A morphism $f : X_\bullet \rightarrow Y_\bullet$ of simplicial varieties (or the simplicial variety X_\bullet itself) is called an S -*hypercovering* if the adjunction morphisms

$$X_n \rightarrow (\text{cosq}_{n-1}^{Y_\bullet} \text{sq}_{n-1} X_\bullet)_n$$

are in S . If S is the class of proper, surjective morphisms, we call X_\bullet a *proper hypercover* of Y_\bullet .

Definition 1.5.9. A simplicial variety X_\bullet is called *split* if for all $n \in \mathbb{N}_0$

$$N(X_n) := X_n \setminus \bigcup_{i=0}^{n-1} s_i(X_{n-1})$$

is an open and closed subvariety of X_n .

We call $N(X_n)$ the *non-degenerate part* of X_n . If X_\bullet is a split simplicial variety, we have a decomposition as varieties

$$X_n = N(X_n) \amalg \coprod_{m < n} \coprod_{s \in S_{m,n}} sN(X_m),$$

where $S_{m,n}$ is the set of degeneracy maps from X_m to X_n .

Theorem 1.5.10 (Deligne). *Let k be a field and Y a variety over k . Then there is a split simplicial variety X_\bullet with all X_n smooth and a proper hypercover $X_\bullet \rightarrow Y$.*

Proof. The construction is given in [Del74b, Section (6.2.5)]. It depends on the existence of resolutions of singularities. In positive characteristic, we may use de Jong's result on alterations [dJ96] instead. \square

The other case we are going to need is the case of additive categories.

Definition 1.5.11. Let \mathcal{A} be an additive category. We define a functor

$$C : \mathcal{A}^\Delta \rightarrow C^-(\mathcal{A})$$

by mapping a simplicial object X_\bullet to the cohomological complex

$$\dots X_{-n} \xrightarrow{d^{-n}} X_{-(n-1)} \rightarrow \dots \rightarrow X_0 \rightarrow 0$$

with differential

$$d^{-n} = \sum_{i=0}^n (-1)^i \partial_i.$$

We define a functor

$$C : \mathcal{A}^{\Delta^\circ} \rightarrow C^+(\mathcal{A})$$

by mapping a cosimplicial object X^\bullet to the cohomological complex

$$0 \rightarrow X^0 \rightarrow \cdots \rightarrow X^n \xrightarrow{d^n} X_{n+1} \rightarrow \cdots$$

with differential

$$d^n = \sum_{i=0}^n (-1)^i \partial_i.$$

Let \mathcal{A} be an abelian category. We define a functor

$$N : \mathcal{A}^{\Delta^\circ} \rightarrow C^+(\mathcal{A})$$

by mapping a cosimplicial object X^\bullet to the *normalised complex* $N(X^\bullet)$ with

$$N(X^\bullet)_n = \bigcap_{i=0}^{n-1} \text{Ker}(s_i : X^n \rightarrow X^{n-1})$$

and differential $d^n|_{N(X^\bullet)}$.

Proposition 1.5.12 (Dold–Kan correspondence). *Let \mathcal{A} be an abelian category and $X^\bullet \in \mathcal{A}^{\Delta^\circ}$ a cosimplicial object. Then the natural map*

$$N(X^\bullet) \rightarrow C(X^\bullet)$$

is a quasi-isomorphism.

Proof. This is the dual result of [Wei94, Theorem 8.3.8]. □

Remark 1.5.13. We are going to apply this in the case of cosimplicial complexes, i.e., to $C(\mathcal{A})^{\Delta^\circ}$, where \mathcal{A} is abelian, e.g., a category of vector spaces.

1.6 Grothendieck topologies

Grothendieck topologies generalise the notion of open covers in topological spaces. Using them one can define cohomology theories in more abstract settings. To define a Grothendieck topology, we need the notion of a *site* (or *situs*). Let \mathcal{C} be a category. A basis for a Grothendieck topology on \mathcal{C} is given by *covering families* in the category \mathcal{C} satisfying the following definition.

Definition 1.6.1. A *site* is a category \mathcal{C} together with a collection of morphisms in \mathcal{C}

$$(\varphi_i : V_i \longrightarrow U)_{i \in I},$$

the *covering families*.

The covering families satisfy the following axioms:

- Any isomorphism $\varphi : V \rightarrow U$ is a covering family with an index set containing only one element.
- If $(\varphi_i : V_i \rightarrow U)_{i \in I}$ is a covering family, and $f : V \rightarrow U$ a morphism in \mathcal{C} , then for each $i \in I$ there exists the pullback diagram

$$\begin{array}{ccc} V \times_U V_i & \xrightarrow{F_i} & V_i \\ \Phi_i \downarrow & & \downarrow \varphi_i \\ V & \xrightarrow{f} & U \end{array}$$

in \mathcal{C} , and $(\Phi_i : V \times_U V_i \rightarrow V)_{i \in I}$ is a covering family of V .

- If $(\varphi_i : V_i \rightarrow U)_{i \in I}$ is a covering family of U , and for each V_i there is given a covering family $(\varphi_j^i : V_j^i \rightarrow V_i)_{j \in J(i)}$, then

$$(\varphi_i \circ \varphi_j^i : V_j^i \rightarrow U)_{i \in I, j \in J(i)}$$

is a covering family of U .

Example 1.6.2. Let X be a topological space. Then the category of open sets in X together with inclusions as morphisms form a site, where the covering maps are the families $(U_i)_{i \in I}$ of open subsets of U such that $\bigcup_{i \in I} U_i = U$. Thus each topological space defines a canonical site. For the Zariski open subsets of a scheme X this is called the (*small*) *Zariski site* of X .

Definition 1.6.3. A *presheaf* \mathcal{F} of abelian groups on a site \mathcal{C} is a contravariant functor

$$\mathcal{F} : \mathcal{C} \rightarrow \text{Ab}, \quad U \mapsto \mathcal{F}(U).$$

A presheaf \mathcal{F} is a *sheaf* if for each covering family $(\varphi_i : V_i \rightarrow U)_{i \in I}$, the difference kernel sequence

$$0 \rightarrow \mathcal{F}(U) \rightarrow \prod_{i \in I} \mathcal{F}(V_i) \rightrightarrows \prod_{(i,j) \in I \times I} \mathcal{F}(V_i \times_U V_j)$$

is exact. This means that a section $s \in \mathcal{F}(U)$ is determined by its restrictions to each V_i , and a tuple $(s_i)_{i \in I}$ of sections comes from a section on U , if one has $s_i = s_j$ on pullbacks to the fibre product $V_i \times_U V_j$.

Once we have a notion of sheaves in a certain Grothendieck topology, then we may define cohomology groups $H^*(X, \mathcal{F})$ by using injective resolutions as in Section 1.4 as the right derived functor of the left-exact global section functor $X \mapsto \mathcal{F}(X) = H^0(X, \mathcal{F})$.

Example 1.6.4. The (*small*) *étale site* over a smooth variety X consists of the category of all étale morphisms $\varphi : U \rightarrow X$ from a smooth variety U to X . See [Har77, Chapter III] for the notion of étale maps. We just note here

that étale maps are quasi-finite, i.e., have finite fibres, are unramified, and the image $\varphi(U) \subset X$ is a Zariski open subset.

A morphism in this site is given by a commutative diagram

$$\begin{array}{ccc} V & \xrightarrow{f} & U \\ \downarrow & & \downarrow \\ X & \xrightarrow{\text{id}} & X. \end{array}$$

Let U be étale over X . A family $(\varphi_i : V_i \rightarrow U)_{i \in I}$ of étale maps over U is called a covering family of U if $\bigcup_{i \in I} \varphi_i(V_i) = U$, i.e., the images form a Zariski open covering of U .

This category has enough injectives by Grothendieck [AGV72], and thus we can define étale cohomology $H_{\text{ét}}^*(X, \mathcal{F})$ for étale sheaves \mathcal{F} .

Example 1.6.5. In Section 2.7 we are going to introduce the h' -topology on the category of analytic spaces.

Definition 1.6.6. Let \mathcal{C} and \mathcal{C}' be sites. A *morphism of sites* $f : \mathcal{C} \rightarrow \mathcal{C}'$ consists of a functor $F : \mathcal{C}' \rightarrow \mathcal{C}$ (sic) which preserves fibre products and such that F applied to a covering family of \mathcal{C}' yields a covering family of \mathcal{C} .

A morphism of sites induces an adjoint pair of functors (f^*, f_*) between sheaves of sets on \mathcal{C} and \mathcal{C}' .

- Example 1.6.7.** 1. Let $f : X \rightarrow Y$ be a continuous map of topological spaces. As in Example 1.6.2 we view them as sites. Then the functor F , mapping an open subset U of Y to its preimage $f^{-1}(U)$, defines a morphism of sites.
2. Let X be a scheme. Then there is a morphism of sites from the small étale site of X to the Zariski site of X . The functor views an open subscheme $U \subset X$ as an étale X -scheme. Open covers are in particular étale covers.

Definition 1.6.8. Let \mathcal{C} be a site. A \mathcal{C} -*hypercover* is an S -hypercover in the sense of Definition 1.5.8 with S the class of morphisms

$$\prod_{i \in I} \phi_i : \prod_{i \in I} U_i \rightarrow U$$

for all covering families $\{\phi_i : U_i \rightarrow U\}_{i \in I}$ in the site.

If X_\bullet is a simplicial object and \mathcal{F} is a presheaf of abelian groups, then $\mathcal{F}(X_\bullet)$ is a cosimplicial abelian group. By applying the functor C of Definition 1.5.11, we get a complex of abelian groups.

Proposition 1.6.9. *Let \mathcal{C} be a site closed under finite products and fibre products and \mathcal{F} a sheaf of abelian groups on \mathcal{C} , $X \in \mathcal{C}$. Then*

$$H^i(X, \mathcal{F}) = \lim_{X_\bullet \rightarrow X} H^i(C(\mathcal{F}(X_\bullet))),$$

where the direct limit runs through the system of all \mathcal{C} -hypercovers of X .

Proof. This is [Ver72, Théorème 7.4.1]. □

Example 1.6.10. If X is a scheme viewed as a site as in Example 1.6.2, this generalises the results of Section 1.4.3. If $\{U_1, \dots, U_n\}$ is an open cover of X , put $p = \coprod_{i=1}^n j_i$. Then $\text{cosq}_0(p)$ (the Č-nerve) is an example of a hypercover. In the coherent situation, it suffices to take the limit over these special hypercovers in Proposition 1.6.9. Moreover, the limit stabilises if we choose the cover to be affine.

1.7 Torsors

Informally, a torsor is a group without a unit. The standard definition in algebraic geometry is sheaf theoretic: a torsor under a sheaf of groups G is a sheaf of sets X with an operation $G \times X \rightarrow X$ such that there is a cover over which X becomes isomorphic to G and the action becomes the group operation. This makes sense on any site.

In this section, we are going to discuss a variant of this idea which does not involve sites or topologies but rather schemes. This approach fits well with the Tannaka formalism that will be discussed in Chapters 8.4 and 13.

It is used by Kontsevich in [Kon99]. This notion goes back at least to a paper of R. Baer [Bae29] from 1929, see the footnote on page 202 of loc. cit. where Baer explains how the notion of a torsor comes up in the context of earlier work of H. Prüfer [Prü24]. In yet another context, ternary operations satisfying these axioms are called associative Malcev operations, see [Joh89] for a short account.

1.7.1 Sheaf-theoretic definition

Definition 1.7.1. Let \mathcal{C} be a category equipped with a Grothendieck topology t . Assume S is a final object of \mathcal{C} . Let G be a group object in \mathcal{C} . A (left) G -torsor is an object X with a (left) operation

$$\mu : G \times X \rightarrow X$$

such that there is a t -covering $U \rightarrow S$ trivialising G . This means that the restriction of G and X to U is the trivial torsor, i.e., $X(U)$ is non-empty, and the choice of any $x \in X(U)$ induces a natural isomorphism

$$\begin{aligned} \mu(\cdot, x) : G(U') &\rightarrow X(U') \\ g &\mapsto \mu(g, x). \end{aligned}$$

for all $U' \rightarrow U$.

This condition can also be formulated by asking the natural map

$$\begin{aligned} G \times U &\rightarrow X \times U \\ (g, u) &\mapsto (g(u), u) \end{aligned}$$

to be an isomorphism.

Remark 1.7.2. 1. As μ is an operation, the isomorphism of the definition is compatible with the operation as well, i.e., the diagram

$$\begin{array}{ccc} G(U') \times X(U') & \xrightarrow{\mu} & X(U') \\ (\text{id}, \mu(\cdot, x)) \uparrow & & \uparrow \mu(\cdot, x) \\ G(U') \times G(U') & \longrightarrow & G(U') \end{array}$$

commutes.

2. If, moreover, $X \rightarrow S$ is a t -cover, then $X(X)$ is always non-empty and we recover a version of the definition that often appears in the literature, namely that

$$G \times X \rightarrow X \times X$$

has to be an isomorphism.

We are interested in the topology that is in use in Tannaka theory. It is basically the flat topology, but we have to be careful what we mean by this because the schemes involved are not of finite type over the base.

Definition 1.7.3. Let S be an affine scheme and \mathcal{C} the category of affine S -schemes. The *fpqc*-topology on \mathcal{C} is generated by covers of the form $X \rightarrow Y$ with $\mathcal{O}(X)$ faithfully flat over $\mathcal{O}(Y)$.

The letters *fpqc* abbreviate the french notion “*fidèlement plat quasi-compact*”. Recall that $\text{Spec}(A)$ is quasi-compact for all rings A .

We do not discuss the non-affine case at all, but see the survey [Vis05] by Vistoli for the general case. The topology is discussed in [Vis05, Section 2.3.2]. The above formulation follows from loc. cit. Lemma 2.60.

Remark 1.7.4. If, moreover, $S = \text{Spec}(k)$ is the spectrum of a field, then any non-trivial morphism $\text{Spec}(A) \rightarrow \text{Spec}(k)$ is an *fpqc*-cover. Hence, we are in the situation of Remark 1.7.2. Note that X still has to be non-empty!

The importance of the *fpqc*-topology is that all representable presheaves are *fpqc*-sheaves, see [Vis05, Theorem 2.55].

1.7.2 Torsors in the category of sets

There is another amazingly simple definition of torsors as sets.

Definition 1.7.5 ([Bae29] p. 202, [Kon99] p. 61, [Fri04] Definition 7.2.1). A *torsor* is a set X together with a map

$$(\cdot, \cdot, \cdot) : X \times X \times X \rightarrow X$$

satisfying:

1. $(x, y, y) = (y, y, x) = x$ for all $x, y \in X$
2. $((x, y, z), u, v) = (x, (u, z, y), v) = (x, y, (z, u, v))$ for all $x, y, z, u, v \in X$.

Morphisms are defined in the obvious way, i.e., maps $X \rightarrow X'$ of sets commuting with the torsor structure.

Lemma 1.7.6. *Let G be a group. Then $(g, h, k) = gh^{-1}k$ defines a torsor structure on G .*

Proof. This is a direct computation:

$$\begin{aligned} (x, y, y) &= xy^{-1}y = x = yy^{-1}x = (y, y, x), \\ ((x, y, z), u, v) &= (xy^{-1}z, u, v) = xy^{-1}zu^{-1}v = (x, y, zu^{-1}v) = (x, y, (z, u, v)), \\ (x, (u, z, y), v) &= (x, uz^{-1}y, v) = x(uz^{-1}y)^{-1}v = xy^{-1}zu^{-1}v. \end{aligned}$$

□

Lemma 1.7.7 ([Bae29] page 202). *Let X be a torsor and $e \in X$ an element. Then $G_e := X$ carries a group structure via*

$$gh := (g, e, h), \quad g^{-1} := (e, g, e).$$

Moreover, the torsor structure on X is given by the formula

$$(g, h, k) = gh^{-1}k$$

in G_e .

Proof. First we show associativity:

$$(gh)k = (g, e, h)k = ((g, e, h), e, k) = (g, e, (h, e, k)) = g(h, e, k) = g(hk).$$

e becomes the neutral element:

$$eg = (e, e, g) = g; \quad ge = (g, e, e) = g.$$

We also have to show that g^{-1} is indeed the inverse element:

$$gg^{-1} = g(e, g, e) = (g, e, (e, g, e)) = ((g, e, e), g, e) = (g, g, e) = e.$$

Similarly one shows that $g^{-1}g = e$. One gets the torsor structure back, since

$$\begin{aligned} gh^{-1}k &= g(e, h, e)k = (g, e, (e, h, e))k = ((g, e, (e, h, e)), e, k) \\ &= (g, (e, (e, h, e), e), k) = (g, ((e, e, h), e, e), k) \\ &= (g, (h, e, e), k) = (g, h, k). \end{aligned}$$

□

Proposition 1.7.8. *Let X be a torsor. Let $\mu_l : X^2 \times X^2 \rightarrow X^2$ be given by*

$$\mu_l((a, b), (c, d)) = ((a, b, c), d).$$

Then μ_l is associative and has (x, x) for $x \in X$ as left-neutral elements. Let $G^l = X^2 / \sim_l$ where $(a, b) \sim_l \mu_l((a, b), (x, x))$ for all $x \in X$ is an equivalence relation. Then μ_l is well-defined on G^l and turns G^l into a group. Moreover, the torsor structure map factors via a simply transitive left G^l -operation on X which is defined by

$$(a, b)x := (a, b, x).$$

Let $e \in X$. Then

$$i_e : G_e \rightarrow G^l, \quad x \mapsto (x, e)$$

is a group isomorphism inverse to $(a, b) \mapsto (a, b, e)$.

In a similar way, using $\mu_r((a, b), (c, d)) := (a, (b, c, d))$ we obtain a group G^r with analogous properties acting transitively on the right on X and such that μ_r factors through the action $X \times G^r \rightarrow X$.

Proof. First we check associativity of μ_l (skipping μ_l in notation):

$$\begin{aligned} (a, b)[(c, d)(e, f)] &= (a, b)((c, d, e), f) = ((a, b, (c, d, e)), f) \\ &= (((a, b, c), d, e), f), \\ [(a, b)(c, d)](e, f) &= ((a, b, c), d)(e, f) = (((a, b, c), d, e), f). \end{aligned}$$

(x, x) is a left neutral element for every $x \in X$:

$$(x, x)(a, b) = ((x, x, a), b) = (a, b).$$

We also need to check that \sim_l is an equivalence relation: \sim_l is reflexive, since one has $(a, b) = ((a, b, b), b) = (a, b)(b, b)$ by the first torsor axiom and the definition of μ_l . For symmetry, assume $(c, d) = (a, b)(x, x)$. Then

$$\begin{aligned} (a, b) &= ((a, b, b), b) = ((a, b, (x, x, b)), b) = (((a, b, x), x, b), b) \\ &= ((a, b, x), x)(b, b) = (a, b)(x, x)(b, b) = (c, d)(b, b) \end{aligned}$$

again by the torsor axioms and the definition of μ_l . For transitivity observe that

$$(a, b)(x, x)(y, y) = (a, b)((x, x, y), y) = (a, b)(y, y).$$

Now we show that μ_l is well-defined on G^l :

$$[(a, b)(x, x)][(c, d)(y, y)] = (a, b)[(x, x)(c, d)](y, y) = (a, b)(c, d)(y, y).$$

The inverse element to (a, b) in G^l is given by (b, a) , since

$$(a, b)(b, a) = ((a, b, b), a) = (a, a).$$

Define the left G^l -operation on X by $(a, b)x := (a, b, x)$. This is compatible with μ_l , since

$$\begin{aligned} [(a, b)(c, d)]x &= ((a, b, c), d)x = ((a, b, c), d, x), \\ (a, b)[(c, d)x] &= (a, b)(c, d, x) = ((a, b, (c, d, x))) \end{aligned}$$

are equal by the second torsor axiom. The left G^l -operation is well-defined with respect to \sim_l :

$$\begin{aligned} [(a, b)(x, x)]y &= ((a, b, x), x)y = ((a, b, x), x, y) \\ &= (a, (x, x, b), y) = (a, b, y) = (a, b)y. \end{aligned}$$

Now we show that i_e is a group homomorphism:

$$ab = (a, e, b) \mapsto ((a, e, b), e) = (a, e)(b, e).$$

The inverse group homomorphism is given by

$$(a, b)(c, d) = ((a, b, c), d) \mapsto ((a, b, c), d, e).$$

On the other hand, one has in G_e :

$$(a, b, e)(c, d, e) = ((a, b, e), e, (c, d, e)) = (a, b, (e, e, (c, d, e))) = (a, b, (c, d, e)).$$

This shows that i_e is an isomorphism. The fact that G_e is a group implies that the operation of G^l on X is simply transitive. Indeed, the group structure on $G_e = X$ is the one induced by the operation of G^l . The analogous group G^r is constructed using μ_r and an equivalence relation \sim_r with opposite order, i.e., $(a, b) \sim_r (x, x)(a, b)$ for all $x \in X$. The properties of G^r can be verified in the same way as for G^l and are left to the reader. \square

1.7.3 Torsors in the category of schemes (without groups)

Definition 1.7.9. Let S be a scheme. A *torsor* in the category of S -schemes is a non-empty scheme X and a morphism

$$X \times X \times X \rightarrow X$$

which on T -valued points is a torsor in the sense of Definition 1.7.5 for all T over S .

This simply means that the diagrams of the previous definition commute in the category of schemes. The following is the scheme theoretic version of Lemma 1.7.8.

Recall the *fpqc*-topology of Definition 1.7.3.

Proposition 1.7.10. *Let S be affine. Let X be a torsor in the category of affine schemes. Assume that X/S is faithfully flat. Then there are affine group schemes G^l and G^r operating from the left and right on X , respectively, such that the natural maps*

$$\begin{aligned} G^l \times X &\rightarrow X \times X & (g, x) &\mapsto (gx, x) \\ X \times G^r &\rightarrow X \times X & (x, g') &\mapsto (x, xg') \end{aligned}$$

are isomorphisms.

Moreover, X is a left G^l - and right G^r -torsor with respect to the *fpqc*-topology on the category of affine schemes.

Proof. We consider G^l . The arguments for G^r are the same. We define G^l as the *fpqc*-sheafification of the presheaf

$$T \mapsto X^2(T)/\sim_l$$

We are going to see below that it is representable by an affine scheme. The map of presheaves μ_l defines a multiplication on G^l . It is associative as it is associative on the presheaf level.

We construct the neutral element. Recall that $X \rightarrow S$ is an *fpqc*-cover. The diagonal $\Delta : X \rightarrow X^2/\sim_l$ induces a section $e \in G^l(X)$. It satisfies descent for the cover X/S by the definition of the equivalence relation \sim_l . Hence it defines an element $e \in G^l(S)$. We claim that it is the neutral element of G . This can be tested *fpqc*-locally, e.g., after base change to X . For T/X the set $X(T)$ is non-empty, hence $X^2/\sim_l(T)$ is a group with neutral element e by Proposition 1.7.8.

The inversion map ι exists on $X^2(T)/\sim_l$ for T/X , hence it also exists and is the inverse on $G^l(T)$ for T/X . By the sheaf condition this gives a well-defined map with the correct properties on G .

By the same arguments, the action homomorphism $(X^2(T)/\sim_l) \times X(T) \rightarrow X(T)$ defines a left action $G^l \times X \rightarrow X$. The induced map $G^l \times X \rightarrow X \times X$ is an isomorphism because it is an isomorphism on the presheaf level for T/X . In particular, X is a left G^l -torsor.

We now turn to representability.

We are going to construct G^l by flat descent with respect to the faithfully flat cover $X \rightarrow S$ following [BLR90, Section 6.1]. In order to avoid confusion, put $T = X$ and $Y = X \times X$ viewed as T -scheme over the second factor. A descent datum on $Y \rightarrow T$ consists of the choice of an isomorphism

$$\phi : p_1^*Y \rightarrow p_2^*Y$$

subject to the cocycle condition

$$p_{13}^*\phi = p_{23}^*\phi \circ p_{12}^*\phi$$

with the obvious notation. We have $p_1^*Y = Y \times T = X^2 \times X$ and $p_2^*Y = T \times Y = X \times X^2$ and use

$$\phi(x_1, x_2, x_3) = (x_2, \rho(x_1, x_2, x_3), x_3)$$

where $\rho : X^3 \rightarrow X$ is the structural morphism of X . We have $p_{12}^*p_1^*Y = X^2 \times X \times X$ etc. and

$$\begin{aligned} p_{12}^*\phi(x_1, x_2, x_3, x_4) &= (x_2, \rho(x_1, x_2, x_3), x_3, x_4) \\ p_{23}^*\phi(x_1, x_2, x_3, x_4) &= (x_1, x_3, \rho(x_2, x_3, x_4), x_4) \\ p_{13}^*\phi(x_1, x_2, x_3, x_4) &= (x_2, x_3, \rho(x_1, x_3, x_4), x_4) \end{aligned}$$

and the cocycle condition is equivalent to

$$\rho(\rho(x_1, x_2, x_3), x_3, x_4) = \rho(x_1, x_2, x_4),$$

which is an immediate consequence of the properties of a torsor. In the affine case (which we are in) any descent datum is effective, i.e., induced from a uniquely determined S -scheme \tilde{G}^l . In other words, it represents the *fpqc*-sheaf defined as the coequaliser of

$$X^2 \times X \rightrightarrows X^2$$

with respect to the projection p_1 mapping (x_1, x_2, x_3) to (x_1, x_2) and $p_2 \circ \phi : X^2 \times X \rightarrow X \times X^2 \rightarrow X^2$ mapping

$$(x_1, x_2, x_3) \mapsto (x_2, \rho(x_1, x_2, x_3), x_3) \mapsto (\rho(x_1, x_2, x_3), x_3).$$

This is precisely the equivalence relation \sim_l . Hence

$$\tilde{G}^l = X^2 / \sim_l$$

as *fpqc*-sheaves. □

Remark 1.7.11. If S is the spectrum of a field, then the flatness assumption is always satisfied. In general, some kind of assumption is needed, as the following example shows. Let S be the spectrum of a discrete valuation ring with closed point ξ . Let G be an algebraic group over ξ and $X = G$ the trivial torsor defined by G . In particular, we have the structure map

$$X \times_{\xi} X \times_{\xi} X \rightarrow X.$$

We now view X as an S -scheme. Note that

$$X \times_S X \times_S X = X \times_{\xi} X \times_{\xi} X,$$

hence X is also a torsor over S in the sense of Definition 1.7.9. However, it is not a torsor with respect to the *fpqc*-topology (or any other reasonable Grothendieck topology) as $X(T)$ is empty for all surjective maps $T \rightarrow S$.

Chapter 2

Singular Cohomology

In this chapter we give a short introduction to singular cohomology. Many properties are only sketched, as this theory is considerably better known than de Rham cohomology, for example.

2.1 Relative cohomology

Let X be a topological space. Sometimes, if indicated, X will be the underlying topological space of an analytic or algebraic variety, also denoted by X . To avoid technicalities, X will always be assumed to be a locally compact, Hausdorff space, and satisfying the second countability axiom. In particular, it is paracompact.

From now on, let \mathcal{F} be a sheaf of abelian groups on X and consider sheaf cohomology $H^i(X, \mathcal{F})$ from Section 1.4. Mostly, we will consider the case of the constant sheaf $\mathcal{F} = \mathbb{Z}$. All statements also hold with \mathbb{Z} replaced by \mathbb{Q} or \mathbb{C} .

Definition 2.1.1 (Relative Cohomology). For $A \subset X$ a closed subset, $U = X \setminus A$ the open complement, and $i : A \hookrightarrow X$ and $j : U \hookrightarrow X$ be the inclusion maps. We define *relative cohomology* as

$$H^i(X, A; \mathbb{Z}) := H^i(X, j_! \mathbb{Z}),$$

where $j_!$ is the extension by zero, i.e., the sheafification of the presheaf

$$V \mapsto \begin{cases} \mathbb{Z} & V \subset U, \\ 0 & \text{else.} \end{cases}$$

Convention 2.1.2. If X is an algebraic variety defined over a field k contained in \mathbb{C} and $A \subset X$ a closed subvariety defined over k , we abbreviate

$$H^i(X, A; \mathbb{Z}) = H^i(X^{\text{an}}, A^{\text{an}}; \mathbb{Z})$$

where X^{an} and A^{an} are the analytifications of $X \times_k \mathbb{C}$ and $A \times_k \mathbb{C}$, respectively.

Remark 2.1.3 (Functoriality and homotopy invariance). The association

$$(X, A) \mapsto H^i(X, A; \mathbb{Z})$$

is a contravariant functor from pairs of topological spaces to abelian groups. In particular, for every continuous map $f : (X, A) \rightarrow (X', A')$ of pairs, i.e., satisfying $f(A) \subset A'$, one has a homomorphism $f^* : H^i(X', A'; \mathbb{Z}) \rightarrow H^i(X, A; \mathbb{Z})$. Given two homotopic maps f and g , the homomorphisms f^* , g^* are equal. As a consequence, if two pairs (X, A) and (X', A') are homotopy equivalent, then the cohomology groups $H^i(X', A'; \mathbb{Z})$ and $H^i(X, A; \mathbb{Z})$ are isomorphic.

Proposition 2.1.4. *There is a long exact sequence*

$$\cdots \rightarrow H^i(X, A; \mathbb{Z}) \rightarrow H^i(X, \mathbb{Z}) \rightarrow H^i(A, \mathbb{Z}) \xrightarrow{\delta} H^{i+1}(X, A; \mathbb{Z}) \rightarrow \cdots$$

Proof. This follows from the exact sequence of sheaves

$$0 \rightarrow j_! \mathbb{Z} \rightarrow \mathbb{Z} \rightarrow i_* \mathbb{Z} \rightarrow 0.$$

□

Note that by our definition of cones, see Section 1.3, one has a quasi-isomorphism $j_! \mathbb{Z} = \text{Cone}(\mathbb{Z} \rightarrow i_* \mathbb{Z})[-1]$. For Nori motives we need a version for triples, which can be proved using iterated cones by the same method:

Corollary 2.1.5. *Let $X \supset A \supset B$ be a triple of relative closed subsets. Then there is a long exact sequence*

$$\cdots \rightarrow H^i(X, A; \mathbb{Z}) \rightarrow H^i(X, B; \mathbb{Z}) \rightarrow H^i(A, B; \mathbb{Z}) \xrightarrow{\delta} H^{i+1}(X, A; \mathbb{Z}) \rightarrow \cdots$$

Here, δ is the connecting homomorphism, which in the cone picture is explained in Section 1.3.

Proposition 2.1.6 (Mayer–Vietoris). *Let $\{U, V\}$ be an open cover of X . Let $A \subset X$ be closed. Then there is a natural long exact sequence*

$$\begin{aligned} \cdots \rightarrow H^i(X, A; \mathbb{Z}) &\rightarrow H^i(U, U \cap A; \mathbb{Z}) \oplus H^i(V, V \cap A; \mathbb{Z}) \\ &\rightarrow H^i(U \cap V, U \cap V \cap A; \mathbb{Z}) \rightarrow H^{i+1}(X, A; \mathbb{Z}) \rightarrow \cdots \end{aligned}$$

Proof. Pairs (U, V) of open subsets form an excisive couple in the sense of [Spa66, p. 188], and therefore the Mayer–Vietoris property holds by [Spa66, p. 189–190]. □

Theorem 2.1.7 (Proper base change). *Let $\pi : X \rightarrow Y$ be proper, i.e., the preimage of a compact subset is compact. Let \mathcal{F} be a sheaf on X . Then the stalk in $y \in Y$ is computed as*

$$(R^i \pi_* \mathcal{F})_y = H^i(X_y, \mathcal{F}|_{X_y}).$$

Proof. See [KS90, Proposition 2.6.7]. As π is proper, we have $R\pi_* = R\pi_!$. \square

Now we list some properties of the sheaf cohomology of algebraic varieties over a field $k \hookrightarrow \mathbb{C}$. As usual, we will not distinguish in notation between a variety X and the topological space of the analytification X^{an} . The first property is:

Proposition 2.1.8 (Excision, or abstract blow-up). *Let $f : (X', D') \rightarrow (X, D)$ be a proper, surjective morphism of algebraic varieties over \mathbb{C} , which induces an isomorphism $f : X' \setminus D' \rightarrow X \setminus D$. Then*

$$f^* : H^*(X, D; \mathbb{Z}) \cong H^*(X', D'; \mathbb{Z}).$$

Proof. This fact goes back to A. Aeppli [Aep57]. It is a special case of proper base change: let $j : U \rightarrow X$ be the complement of D and $j' : U \rightarrow X'$ its inclusion into X' . For all $x \in X$, we have

$$(R^i f_* j'_! \mathbb{Z})_x = H^i(X_x, j'_! \mathbb{Z}|_{X'_x}).$$

For $x \in U$, the fibre is one point. It has no higher cohomology. For $x \in D$, the restriction of $j'_! \mathbb{Z}$ to X'_x is zero. Together this means

$$Rf_* j'_! \mathbb{Z} = j_! \mathbb{Z}.$$

The statement then follows from the Leray spectral sequence [Spa66]. \square

We will later prove a slightly more general proper base change theorem for singular cohomology, see Theorem 2.5.12.

The second property is:

Proposition 2.1.9 (Gysin isomorphism, localisation, weak purity). *Let X be an irreducible variety of dimension n over k , and Z a closed subvariety of pure codimension r . Then there is an exact sequence*

$$\dots \rightarrow H_Z^i(X, \mathbb{Z}) \rightarrow H^i(X, \mathbb{Z}) \rightarrow H^i(X \setminus Z, \mathbb{Z}) \rightarrow H_Z^{i+1}(X, \mathbb{Z}) \rightarrow \dots$$

where $H_Z^i(X, \mathbb{Z})$ is cohomology with supports in Z , defined as the cohomology of $\text{Cone}(\mathbb{Z} \rightarrow Rj_* \mathbb{Z})[-1]$ for the open immersion $j : X \setminus Z \rightarrow X$.

If, moreover, X and Z are both smooth, then one has the Gysin isomorphism

$$H_Z^i(X, \mathbb{Z}) \cong H^{i-2r}(Z, \mathbb{Z}).$$

In particular, one has weak purity:

$$H_{\mathbb{Z}}^i(X, \mathbb{Z}) = 0 \text{ for } i < 2r,$$

and $H_{\mathbb{Z}}^{2r}(X, \mathbb{Z}) = H^0(Z, \mathbb{Z})$ is free of rank equal to the number of components of Z .

Proof. A modern presentation of such properties of cohomology theories is given in [Pan03, Section 2]. It contains other examples of cohomology theories and an axiomatic treatment with more general properties. \square

2.2 Singular (co)homology

Let X be a topological space satisfying the same general assumptions as in Section 2.1. The definition of singular homology and cohomology uses topological simplexes.

Definition 2.2.1. The *topological n -simplex* Δ_n is defined as

$$\Delta_n := \left\{ (t_0, \dots, t_n) \in \mathbb{R}^{n+1} \mid \sum_{i=0}^n t_i = 1, t_i \geq 0 \right\}.$$

Δ_n has natural codimension one faces defined by $t_i = 0$.

Singular (co)homology is defined by looking at all possible continuous maps from simplices to X .

Definition 2.2.2. A *singular n -simplex* is a continuous map

$$f: \Delta_n \rightarrow X.$$

In the case where X is a differentiable manifold, a singular simplex f is called *differentiable* if the map f can be extended to a \mathcal{C}^∞ -map from a neighbourhood of $\Delta_n \subset \mathbb{R}^{n+1}$ to X . The *group of singular n -chains* is the free abelian group

$$S_n(X) := \mathbb{Z}[f: \Delta_n \rightarrow X \mid f \text{ singular } n\text{-simplex}].$$

In a similar way, we denote by $S_n^\infty(X)$ the free abelian *group of differentiable singular n -chains* by requiring that all f are differentiable. The boundary map $\partial_n: S_n(X) \rightarrow S_{n-1}(X)$ is defined as

$$\partial_n(f) := \sum_{i=0}^n (-1)^i f|_{t_i=0}.$$

It respects the subgroups $S_n^\infty(X)$. The *group of singular n -cochains* is the free abelian group

$$S^n(X) := \text{Hom}_{\mathbb{Z}}(S_n(X), \mathbb{Z}).$$

The *group of differentiable singular n -cochains* is the free abelian group

$$S_\infty^n(X) := \text{Hom}_{\mathbb{Z}}(S_n^\infty(X), \mathbb{Z}).$$

The adjoint of ∂_{n+1} defines the boundary map

$$d_n : S_{(\infty)}^n(X) \rightarrow S_{(\infty)}^{n+1}(X).$$

Lemma 2.2.3. *One has $\partial_{n-1}\partial_n = 0$ and $d_{n+1}d_n = 0$, i.e., the groups $S_\bullet(X)$ and $S^\bullet(X)$ define complexes of abelian groups.*

The proof is left to the reader as an exercise.

Definition 2.2.4. Singular homology and cohomology with values in \mathbb{Z} are defined as

$$H_{\text{sing}}^i(X, \mathbb{Z}) := H^i(S^\bullet(X), d_\bullet), \quad H_i^{\text{sing}}(X, \mathbb{Z}) := H_i(S_\bullet(X), \partial_\bullet).$$

In a similar way, we define (for X a manifold) the differentiable singular (co)homology as

$$H_{\text{sing}, \infty}^i(X, \mathbb{Z}) := H^i(S_\infty^\bullet(X), d_\bullet), \quad H_i^{\text{sing}, \infty}(X, \mathbb{Z}) := H_i(S_\infty^\bullet(X), \partial_\bullet).$$

Theorem 2.2.5. *Assume that X is a locally contractible topological space, i.e., every point has an open contractible neighbourhood. In this case, singular cohomology $H_{\text{sing}}^i(X, \mathbb{Z})$ agrees with sheaf cohomology $H^i(X, \mathbb{Z})$ with coefficients in \mathbb{Z} . If Y is a differentiable manifold, differentiable singular (co)homology agrees with singular (co)homology.*

Proof. Let \mathcal{S}^n be the sheaf associated to the presheaf $U \mapsto S^n(U)$. One shows that $\mathbb{Z} \rightarrow \mathcal{S}^\bullet$ is a fine resolution of the constant sheaf \mathbb{Z} [War83, p. 196]. The proof uses that X is locally contractible [War83, p. 194]. If X is a manifold, differentiable cochains also define a fine resolution [War83, p. 196]. Therefore, the inclusion of complexes $S_\infty^\bullet(X) \hookrightarrow S_\bullet(X)$ induces isomorphisms

$$H_{\text{sing}, \infty}^i(X, \mathbb{Z}) \cong H_{\text{sing}}^i(X, \mathbb{Z}) \text{ and } H_i^{\text{sing}, \infty}(X, \mathbb{Z}) \cong H_i^{\text{sing}}(X, \mathbb{Z}).$$

□

Of course, topological manifolds satisfy the assumption of the theorem.

2.3 Simplicial cohomology

In this section, we want to introduce simplicial (co)homology and its relation to singular (co)homology. Simplicial (co)homology can be defined for topological spaces with an underlying combinatorial structure.

The literature contains various notions of such spaces. In increasing order of generality, these are: geometric and abstract simplicial complexes, Δ -

complexes (sometimes also called semi-simplicial complexes), and topological realisations of simplicial sets. A good reference with a discussion of various definitions is the book by Hatcher [Hat02], or the introductory paper [Fri12] by Friedman. We will only look at finitely generated spaces.

By construction, such spaces are built from topological simplices Δ_n in various dimensions n .

Definition 2.3.1. A *geometric n -simplex* is the convex hull of $n + 1$ points v_0, \dots, v_n in some Euclidean space \mathbb{R}^N , such that $v_i - v_0$ are linearly independent for $i = 1, \dots, n$. The *standard (ordered) n -simplex* Δ_n is the convex hull of the standard basis e_0, \dots, e_n of \mathbb{R}^{n+1} .

A *finite geometric simplicial complex* $X \subset \mathbb{R}^N$ is the collection of finitely many geometric simplices in \mathbb{R}^N , such that

- Every face of a simplex of X is again a simplex of X (i.e., contained in X).
- The intersection of two simplices of X is a face of each of them and contained in X .

Using this definition, a finite geometric simplicial complex X induces a topological space also denoted by X , which is a topological quotient of the finite set of geometric simplices of X which are glued along common faces, see [Fri12, Section 2] or [Hat02, Section 2.1]. It can be built up inductively by adjoining simplices of increasing dimensions. The topological space X , i.e., the union of all faces, is not distinguished in notation from the collection X . The restriction to finitely many simplices is not necessary in this definition, but it is enough for our purposes. Geometric simplicial complexes arise more generally in geometric situations in the triangulations of real manifolds or algebraic varieties defined over \mathbb{C} :

Example 2.3.2. An example is the case of an analytic space X^{an} where X is an algebraic variety defined over \mathbb{R} . There one can always find a semi-algebraic triangulation by a result of Lojasiewicz, cf. Hironaka [Hir75, p. 170] and Proposition 2.6.9. See Section 2.6.2 for the notion of a semi-algebraic triangulation.

A little bit more general is the notion of an abstract simplicial complex:

Definition 2.3.3. A *finite abstract simplicial complex* X consists of a finite set of vertices X^0 together with — for each integer n — a set X^n of subsets of $n + 1$ points in X^0 . Subsets of $k + 1$ elements in a set of $n + 1$ elements in X^0 , i.e., k -dimensional faces of n -dimensional faces of X , are contained in X^k . A simplicial complex X is called *ordered* if there is a chosen ordering on X^0 .

Every finite geometric simplicial complex is an abstract finite simplicial complex and can be ordered. Vice versa, one can associate to an abstract simplicial complex a geometric one up to homeomorphism, by associating to each point in X^n an n -simplex and gluing these sets along common faces.

Thus, we will only speak of simplicial complexes. The natural morphisms $f : X \rightarrow Y$ in the category of (abstract, finite) simplicial complexes are the simplicial maps which take the vertices in X^0 to vertices in Y^0 and every k -face of X to a k -face of Y under this map [Fri12, Section 2.2]. A similar definition of morphisms applies to ordered simplicial complexes.

Example 2.3.4. A *tetrahedron* $X = \partial\Delta_3$ is a geometric simplicial complex with four vertices (0-simplices), six non-degenerate edges (1-simplices), and four non-degenerate faces (2-simplices).

The *torus* T^2 has a well-known minimal triangulation with 14 vertices, 21 edges and 7 faces (triangles). The graph formed by the edges and vertices is called the *Heawood graph*. It divides the torus into 7 mutually adjacent regions.

Remark 2.3.5. There is also the slightly more abstract notion of a Δ -complex, which is intermediate between simplicial complexes and simplicial sets, see [Fri12, Section 2.4], [Hat02, Section 2.1]. Every Δ -complex is homeomorphic to a simplicial complex [Hat02, Section 2.1].

Even more generally, one can think of a simplicial space as the topological realisation of a finite simplicial set: Let X_\bullet be a finite simplicial set in the sense of Remark 1.5.5. Then one has the face maps

$$\partial_i : X_n \rightarrow X_{n-1},$$

and the degeneracy maps

$$s_i : X_n \rightarrow X_{n+1}.$$

Every finite simplicial set gives rise to a topological space $|X_\bullet|$:

Definition 2.3.6. The *topological realisation* $|X_\bullet|$ of X_\bullet is defined as

$$|X_\bullet| := \prod_{n=0}^{\infty} X_n \times \Delta_n / \sim,$$

where each X_n carries the discrete topology, Δ_n is the topological n -simplex, and the equivalence relation is given by the two relations

$$\begin{aligned} (x, \partial_i(y)) &\sim (\partial_i(x), y), & x \in X_{n-1}, y \in \Delta_n, \\ (x', s_i(y')) &\sim (s_i(x'), y'), & x' \in X_n, y' \in \Delta_{n-1}. \end{aligned}$$

(Note that we denote the face and degeneracy maps for the n -simplex by the same letters ∂_i, s_i .)

There is no essential difference between working with finite simplicial complexes or realisations of finite simplicial sets:

Proposition 2.3.7. *Let X be a finite simplicial complex. Then there is a finite simplicial set X_\bullet associated to it by adding degeneracies. The spaces $|X_\bullet|$ and X are homeomorphic.*

Proof. See [Fri12, Example 3.3], [Hat02, Appendix A]. \square

Remark 2.3.8. For a finite simplicial set X_\bullet , it is known that the realisation $|X_\bullet|$ is a compactly generated CW-complex [Hat02, Appendix A]. In fact, every finite CW-complex is homotopy equivalent to a finite simplicial complex of the same dimension by [Hat02, Theorem 2C.5].

The skeletal filtration from Remark 1.5.5 defines a filtration of $|X_\bullet|$

$$|\mathrm{sq}_0 X_\bullet| \subseteq |\mathrm{sq}_1 X_\bullet| \subseteq \cdots \subseteq |\mathrm{sq}_N X_\bullet| = |X_\bullet|$$

by closed subspaces, if X_n is degenerate for $n > N$.

There is finite number of simplices in each degree n . Associated to each of them is a continuous map $\sigma : \Delta_n \rightarrow |X_\bullet|$. We denote the free abelian group of all such σ of degree n by $C_n^\Delta(X_\bullet)$ and the maps

$$\partial_n : C_n^\Delta(X_\bullet) \rightarrow C_{n-1}^\Delta(X_\bullet)$$

are given by alternating restriction maps to faces, as in the case of singular homology. Note that the vertices of each simplex are ordered, so that this is well-defined.

Definition 2.3.9. Simplicial homology of the topological space $X = |X_\bullet|$ is defined as

$$H_n^{\mathrm{simp}}(X, \mathbb{Z}) := H_n(C_*^\Delta(X_\bullet), \partial_*),$$

and simplicial cohomology as

$$H_{\mathrm{simp}}^n(X, \mathbb{Z}) := H^n(C_\Delta^*(X_\bullet), d_*),$$

where $C_\Delta^n(X_\bullet) = \mathrm{Hom}(C_n^\Delta(X_\bullet), \mathbb{Z})$ and d_n is adjoint to ∂_n .

This definition does not depend on the representation of a topological space X as the topological realisation of a simplicial set, since one can prove that simplicial (co)homology coincides with singular (co)homology:

Theorem 2.3.10. *Singular and simplicial (co)homology of X are equal.*

Proof. (For homology only.) The chain of closed subsets

$$|\mathrm{sq}_0 X_\bullet| \subseteq |\mathrm{sq}_1 X_\bullet| \subseteq \cdots \subseteq |\mathrm{sq}_N X_\bullet| = |X_\bullet|$$

gives rise to long exact sequences of simplicial homology groups

$$\begin{aligned} \cdots \rightarrow H_n^{\mathrm{simp}}(|\mathrm{sq}_{n-1} X_\bullet|, \mathbb{Z}) &\rightarrow H_n^{\mathrm{simp}}(|\mathrm{sq}_n X_\bullet|, \mathbb{Z}) \\ &\rightarrow H_n^{\mathrm{simp}}(|\mathrm{sq}_{n-1} X_\bullet|, |\mathrm{sq}_n X_\bullet|; \mathbb{Z}) \rightarrow \cdots \end{aligned}$$

A similar sequence holds for singular homology, and there is a canonical map $C_n^\Delta(X) \rightarrow C_n(X)$ from simplicial to singular chains. The result is then proved by induction on n . We use that the relative complex $C_n^\Delta(|\text{sq}_{n-1} X_\bullet|, |\text{sq}_n X_\bullet|)$ has zero differential and is a free abelian group of rank equal to the cardinality of X_n . Therefore, the assertion follows by computing that the singular (co)homology of Δ_n is given by $H^i(\Delta_n, \mathbb{Z}) = \mathbb{Z}$ for $i = 0$ and zero otherwise. \square

In a similar way, one can define the simplicial (co)homology of a pair $(X, D) = (|X_\bullet|, |D_\bullet|)$, where $D_\bullet \subset X_\bullet$ is a simplicial subobject. The associated chain complex is given by the quotient complex $C_*^\Delta(X_\bullet)/C_*^\Delta(D_\bullet)$. The same proof will then show that the singular and simplicial (co)homology of pairs coincide.

Example 2.3.11. For the tetrahedron $X = \partial\Delta_3$, a computation shows that $H_i(X, \mathbb{Z}) = \mathbb{Z}$ for $i = 0, 2$ and zero otherwise. This was a priori clear, since X is topologically a sphere.

For the torus T^2 , one computes $H_1(T^2, \mathbb{Z}) = \mathbb{Z} \oplus \mathbb{Z}$, and $H_0(T^2, \mathbb{Z}) = H_2(T^2, \mathbb{Z}) = \mathbb{Z}$. Both are obvious, as T^2 is topologically a product $S^1 \times S^1$.

In the special case when X is the topological space underlying the analytic space attached to an affine algebraic variety X over \mathbb{C} , or more generally a Stein manifold, one can show:

Theorem 2.3.12 (Artin vanishing). *Let X be an affine variety over \mathbb{C} of dimension n . Then $H^q(X^{\text{an}}, \mathbb{Z}) = 0$ for $q > n$. In fact, X^{an} is homotopy equivalent to the topological realisation of a finite simplicial set where all non-degenerate simplices are of dimension at most n .*

Proof. The proof was first given by Andreotti and Fraenkel [AF59] for Stein manifolds. For Stein spaces, i.e., allowing singularities, this is a theorem of Kaup, Narasimhan and Hamm, see [Ham83, Satz 1] and the correction in [Ham86]. An algebraic proof was given by M. Artin [Art73, Corollaire 3.5, tome 3]. \square

The choice of such a triangulation implies the choice of a skeletal filtration.

Corollary 2.3.13 (Good topological filtration). *Let X be an affine variety over \mathbb{C} of dimension n . Then there is a filtration of X^{an} given by*

$$X^{\text{an}} = X_n \supset X_{n-1} \supset \cdots \supset X_0$$

where the pairs (X_i, X_{i-1}) have only cohomology in degree i . There is an induced chain complex of abelian groups

$$\cdots \rightarrow H^i(X_i, X_{i-1}; \mathbb{Z}) \xrightarrow{\delta_i} H^{i+1}(X_{i+1}, X_i; \mathbb{Z}) \rightarrow \cdots$$

which computes the cohomology of X . The maps δ_i are coboundary maps in the long exact sequences associated to the triples $X_{i-1} \subset X_i \subset X_{i+1}$.

Proof. The existence of the filtration follows from Theorem 2.3.12. The rest of the statements are shown (in the dual homological version) in [Hat02, Theorem 2.35]. \square

Remark 2.3.14. The Basic Lemma of Nori and Beilinson, see Theorem 2.5.7, shows that there is even an algebraic variant of this topological skeletal filtration.

Corollary 2.3.15 (Artin vanishing for relative cohomology). *Let X be an affine variety of dimension n and $Z \subset X$ a closed subvariety. Then*

$$H^i(X, Z; \mathbb{Z}) = 0 \text{ for } i > n.$$

Proof. Consider the long exact sequence for relative cohomology and use Artin vanishing for X and Z from Theorem 2.3.12. \square

The following theorem is strongly related to the Artin vanishing theorem.

Theorem 2.3.16 (Lefschetz hyperplane theorem). *Let $\bar{X} \subset \mathbb{P}_{\mathbb{C}}^N$ be a smooth integral projective variety of dimension n , and $H \subset \bar{X}$ a transversal hyperplane section. Then the inclusion $H \subset \bar{X}$ is $(n-1)$ -connected. In particular, one has $H^q(\bar{X}, H; \mathbb{Z}) = 0$ for $q \leq n-1$.*

Proof. By [AF59, Theorem 2], the map $H^q(\bar{X}, \mathbb{Z}) \rightarrow H^q(H, \mathbb{Z})$ is bijective for $q < n-1$ and injective for $q = n-1$. \square

This also implies an analogous statement in the affine case.

Corollary 2.3.17. *Let \bar{X} be a smooth projective integral variety of dimension n , and $H, H' \subset \bar{X}$ transversal hyperplane sections which are also transversal to each other. Let $X = \bar{X} \setminus H$ and $Z = X \cap H'$. Then $H^q(X, Z; \mathbb{Z})$ vanishes for $q \leq n-1$.*

Proof. By comparing the Gysin sequences of Proposition 2.1.9 for the smooth pairs (\bar{X}, H) and $(H, H' \cap H)$, we also obtain a Gysin sequence in relative cohomology:

$$\begin{aligned} \dots \rightarrow H^{q-2}(H, H' \cap H; \mathbb{Z}) &\rightarrow H^q(\bar{X}, H; \mathbb{Z}) \rightarrow H^q(X, Z; \mathbb{Z}) \\ &\rightarrow H^{q-1}(H, H' \cap H; \mathbb{Z}) \rightarrow \dots \end{aligned}$$

The Lefschetz hyperplane theorem 2.3.16 says that the q -th cohomology groups of (\bar{X}, H) and $(H, H' \cap H)$ vanish for $q \leq n-1$ and $q \leq n-2$, respectively. Hence the cohomology of (X, Z) vanishes for $q \leq n-1$. \square

2.4 The Künneth formula and Poincaré duality

Assume that we are given two topological spaces X and Y , and two closed subsets $i : A \hookrightarrow X$, and $i' : C \hookrightarrow Y$. By the above, using the inclusions $j : X \setminus A \hookrightarrow X$, and $j' : Y \setminus C \hookrightarrow Y$, we have

$$H^*(X, A; \mathbb{Z}) = H^*(X, j_! \mathbb{Z}),$$

and

$$H^*(Y, C; \mathbb{Z}) = H^*(Y, j'_! \mathbb{Z}).$$

The relative cohomology group

$$H^*(X \times Y, X \times C \cup A \times Y; \mathbb{Z})$$

can by definition be computed as $H^*(X \times Y, \tilde{j}_! \mathbb{Z})$, where

$$\tilde{j} : (X \times Y) \setminus (X \times C \cup A \times Y) \hookrightarrow X \times Y$$

is the inclusion map. One has $\tilde{j}_! = j_! \boxtimes j'_!$ where \boxtimes denotes the external tensor product of sheaves. Hence, we have a natural exterior product map

$$H^i(X, A; \mathbb{Z}) \otimes H^j(Y, C; \mathbb{Z}) \xrightarrow{\times} H^{i+j}(X \times Y, X \times C \cup A \times Y; \mathbb{Z}).$$

This is related to the so-called *Künneth formula*:

Theorem 2.4.1 (Künneth formula for pairs). *Let $A \subset X$ and $C \subset Y$ be closed subsets. The exterior product map induces a natural isomorphism*

$$\bigoplus_{i+j=n} H^i(X, A; \mathbb{Q}) \otimes H^j(Y, C; \mathbb{Q}) \xrightarrow{\cong} H^n(X \times Y, X \times C \cup A \times Y; \mathbb{Q}).$$

The same result holds with \mathbb{Z} -coefficients, provided all cohomology groups of (X, A) and (Y, C) in all degrees are free.

Proof. Using the sheaves of singular cochains, see the proof of Theorem 2.2.5, one has fine resolutions $j_! \mathbb{Z} \rightarrow F^\bullet$ on X , and $j'_! \mathbb{Z} \rightarrow G^\bullet$ on Y . The exterior tensor product $F^\bullet \boxtimes G^\bullet$ is thus a fine resolution of $\tilde{j}_! \mathbb{Z} = j_! \mathbb{Z} \boxtimes j'_! \mathbb{Z}$. Here one uses that the tensor product of fine sheaves is fine [War83, p. 193]. The cohomology of the tensor product complex $F^\bullet \otimes G^\bullet$ induces a short exact sequence

$$\begin{aligned} 0 \rightarrow \bigoplus_{i+j=n} H^i(X, A; \mathbb{Z}) \otimes H^j(Y, C; \mathbb{Z}) &\rightarrow H^n(X \times Y, X \times C \cup A \times Y; \mathbb{Z}) \\ &\rightarrow \bigoplus_{i+j=n+1} \mathrm{Tor}_1^{\mathbb{Z}}(H^i(X, A; \mathbb{Z}), H^j(Y, C; \mathbb{Z})) \rightarrow 0 \end{aligned}$$

by [God58, Théorème 5.5.1] or [Wei94, Theorem 3.6.3]. If all cohomology groups are free, the last term vanishes. \square

The following is a standard consequence of the definition of the Künneth isomorphism for complexes of abelian groups:

Proposition 2.4.2. *The Künneth isomorphism of Theorem 2.4.1 is associative and graded commutative.*

In later constructions, we will need a certain compatibility of the exterior product with coboundary maps.

Proposition 2.4.3. *Assume that $X \supset A \supset B$ and $Y \supset C$ are closed subsets. The diagram involving coboundary maps for the triples $X \supset A \supset B$ and $X \times Y \supset X \times C \cup A \times Y \supset X \times C \cup B \times Y$ combined with the excision isomorphism*

$$\begin{array}{ccc} H^i(A, B; \mathbb{Z}) \otimes H^j(Y, C; \mathbb{Z}) & \longrightarrow & H^{i+j}(A \times Y, A \times C \cup B \times Y; \mathbb{Z}) \\ \delta \otimes \text{id} \downarrow & & \downarrow \delta \\ H^{i+1}(X, A; \mathbb{Z}) \otimes H^j(Y, C; \mathbb{Z}) & \longrightarrow & H^{i+j+1}(X \times Y, X \times C \cup A \times Y; \mathbb{Z}) \end{array}$$

commutes up to a sign $(-1)^j$. The diagram

$$\begin{array}{ccc} H^i(Y, C; \mathbb{Z}) \otimes H^j(A, B; \mathbb{Z}) & \longrightarrow & H^{i+j}(Y \times A, Y \times B \cup C \times A; \mathbb{Z}) \\ \text{id} \otimes \delta \downarrow & & \downarrow \delta \\ H^i(Y, C; \mathbb{Z}) \otimes H^{j+1}(X, A; \mathbb{Z}) & \longrightarrow & H^{i+j+1}(Y \times X, Y \times A \cup C \times X; \mathbb{Z}) \end{array}$$

commutes (without a sign).

Proof. We indicate the argument, without going into full details. Let G^\bullet be a complex computing $H^*(Y, C; \mathbb{Z})$. Let F_1^\bullet and F_2^\bullet be complexes computing $H^*(A, B; \mathbb{Z})$ and $H^*(X, A; \mathbb{Z})$. Let K_1^\bullet and K_2^\bullet be the complexes computing cohomology of the corresponding product varieties. The cup product is induced from maps of complexes $F_i^\bullet \otimes G^\bullet \rightarrow K_i^\bullet$. In order to get compatibility with the boundary map, we have to consider the diagram of the form

$$\begin{array}{ccc} F_1^\bullet \otimes G^\bullet & \longrightarrow & K_1^\bullet \\ \downarrow & & \downarrow \\ (F_2^\bullet[1]) \otimes G^\bullet & \longrightarrow & K_2^\bullet[1] \end{array}$$

However, by Lemma 1.3.6, the complexes $(F_2^\bullet[1]) \otimes G^\bullet$ and $(F_2^\bullet \otimes G^\bullet)[1]$ are not equal. We need to introduce the sign $(-1)^j$ in bidegree (i, j) to make the identification and get a commutative diagram.

The argument for the second type of boundary map is the same, but does not need the introduction of signs by Lemma 1.3.6. \square

Assume now that $X = Y$ and $A = C$. Then, $j_! \mathbb{Z}$ has an algebra structure, and we obtain the *cup product* maps:

$$H^i(X, A; \mathbb{Z}) \otimes H^j(X, A; \mathbb{Z}) \longrightarrow H^{i+j}(X, A; \mathbb{Z})$$

via the multiplication maps

$$H^{i+j}(X \times X, \tilde{j}_! \mathbb{Z}) \rightarrow H^{i+j}(X, j_! \mathbb{Z}),$$

induced by

$$\tilde{j}_! = j_! \boxtimes j_! \rightarrow j_!.$$

In the case where $A = \emptyset$, the cup product induces Poincaré duality:

Proposition 2.4.4 (Poincaré duality). *Let X be a compact, orientable topological manifold of dimension m . Then the cup product pairing*

$$H^i(X, \mathbb{Q}) \times H^{m-i}(X, \mathbb{Q}) \longrightarrow H^m(X, \mathbb{Q}) \cong \mathbb{Q}$$

is non-degenerate. With \mathbb{Z} -coefficients, the map

$$H^i(X, \mathbb{Z})/\text{torsion} \times H^{m-i}(X, \mathbb{Z})/\text{torsion} \longrightarrow H^m(X, \mathbb{Z}) \cong \mathbb{Z}$$

is non-degenerate.

Proof. We will give a proof of a slightly more general statement in the algebraic situation below. A proof of the stated theorem can be found in [GH78, p. 53], although it is stated in a homological version. There it is shown that $H^{2n}(X, \mathbb{Z})$ is torsion-free of rank one, and the cup-product pairing is unimodular modulo torsion, using simplicial cohomology, and the relation between Poincaré duality and the dual cell decomposition. \square

We will now prove a relative version in the algebraic case. It implies the version above in the case where $A = B = \emptyset$. By abuse of notation, we again do not distinguish between an algebraic variety over \mathbb{C} and its underlying topological space.

Theorem 2.4.5 (Poincaré duality for algebraic pairs). *Let X be a smooth and proper complex variety of dimension n and $A, B \subset X$ two normal crossing divisors, such that $A \cup B$ is also a normal crossing divisor. Then there is a non-degenerate duality pairing*

$$H^d(X \setminus A, B \setminus (A \cap B); \mathbb{Q}) \times H^{2n-d}(X \setminus B, A \setminus (A \cap B); \mathbb{Q}) \longrightarrow H^{2n}(X, \mathbb{Q}) \cong \mathbb{Q}.$$

Again, with \mathbb{Z} -coefficients this is true modulo torsion.

Proof. We give a sheaf theoretic proof using Verdier duality and some formulas and ideas of Beilinson (see [Bei87]). Look at the commutative diagram:

$$\begin{array}{ccc}
U = X \setminus (A \cup B) & \xrightarrow{\ell_U} & X \setminus A \\
\kappa_U \downarrow & & \downarrow \kappa \\
X \setminus B & \xrightarrow{\ell} & X.
\end{array}$$

Note that the involved morphisms are affine. Assuming $A \cup B$ is a normal crossing divisor, we want to show first that the natural map

$$\ell_! R\kappa_{U*} \mathbb{Q}_U \longrightarrow R\kappa_* \ell_{U!} \mathbb{Q}_U,$$

extending $\text{id} : \mathbb{Q}_U \rightarrow \mathbb{Q}_U$, is an isomorphism. This is a local computation. We look without loss of generality at a neighbourhood of an intersection point $x \in A \cap B$ (in the analytic topology), since the computation at other points is even easier. Hence, we may choose a polydisk neighbourhood D in X around x such that D decomposes as

$$D = D_A \times D_B$$

and such that

$$A \cap D = A_0 \times D_B, \quad B \cap D = D_A \times B_0$$

for some suitable topological spaces A_0, B_0 . Using the same symbols for the maps as in the above diagram, the situation looks locally like

$$\begin{array}{ccc}
(D_A \setminus A_0) \times (D_B \setminus B_0) & \xrightarrow{\ell_U} & (D_A \setminus A_0) \times D_B \\
\kappa_U \downarrow & & \downarrow \kappa \\
D_A \times (D_B \setminus B_0) & \xrightarrow{\ell} & D = D_A \times D_B.
\end{array}$$

Using the Künneth formula, one concludes that both sides $\ell_! R\kappa_{U*} \mathbb{Q}_U$ and $R\kappa_* \ell_{U!} \mathbb{Q}_U$ are isomorphic to

$$R\kappa_{U*} \mathbb{Q}_{D_A \setminus A_0} \boxtimes \ell_! \mathbb{Q}_{D_B \setminus B_0}$$

near the point x , and the natural map provides an isomorphism.

Now, one has

$$H^d(X \setminus A, B \setminus (A \cap B); \mathbb{Q}) = H^d(X, \ell_! \kappa_{U*} \mathbb{Q}_U),$$

(using that the maps involved are affine and hence their higher direct image functors exact), and

$$H^{2n-d}(X \setminus B, A \setminus (A \cap B); \mathbb{Q}) = H^{2n-d}(X, \kappa_! \ell_{U*} \mathbb{Q}_U).$$

We have to show that there is a perfect pairing

$$H^d(X \setminus A, B \setminus (A \cap B); \mathbb{Q}) \times H^{2n-d}(X \setminus B, A \setminus (A \cap B); \mathbb{Q}) \rightarrow \mathbb{Q}.$$

However, by Verdier duality, we have a perfect pairing

$$\begin{aligned} H^{2n-d}(X \setminus B, A \setminus (A \cap B); \mathbb{Q})^\vee &= H^{2n-d}(X, \kappa_! \ell_{U*} \mathbb{Q}_U)^\vee \\ &\cong H^{-d}(X, \kappa_! \ell_{U*} \mathbb{D} \mathbb{Q}_U) \\ &\cong H^{-d}(X, \mathbb{D}(\kappa_* \ell_{U!} \mathbb{Q}_U)) \\ &\cong H^d(X, \kappa_* \ell_{U!} \mathbb{Q}_U) \\ &\cong H^d(X, \ell_! \kappa_{U*} \mathbb{Q}_U) \\ &= H^d(X \setminus A, B \setminus (A \cap B); \mathbb{Q}). \end{aligned}$$

In this computation, \mathbb{D} is Verdier's duality operator on the derived category of constructible sheaves in the analytic topology.

The statement on integral cohomology follows again by unimodularity of the cup-product pairing. \square

Remark 2.4.6. The normal crossing condition is necessary, as one can see in the example of $X = \mathbb{P}^2$, where A consists of two distinct lines meeting in a point, and B a line different from A going through the same point.

2.5 The Basic Lemma

In this section we prove the basic lemma of Nori [Nor00, Nora, Nor02], a topological result, which was also known to Beilinson [Beĭ87] and Vilonen (unpublished). Let $k \subset \mathbb{C}$ be a subfield. Beilinson's proof works more generally in positive characteristics, as we will see below.

2.5.1 Formulations of the Basic Lemma

Convention 2.5.1. We fix an embedding $k \hookrightarrow \mathbb{C}$. All sheaves and all cohomology groups in the following section are to be understood in the analytic topology on $X(\mathbb{C})$.

Theorem 2.5.2 (Basic Lemma I). *Let $k \subset \mathbb{C}$. Let X be an affine variety over k of dimension n and $W \subset X$ be a Zariski closed subset with $\dim(W) < n$. Then there exists a Zariski closed subset $Z \subset X$ defined over k with $\dim(Z) < n$ such that Z contains W and*

$$H^q(X, Z; \mathbb{Z}) = 0, \text{ for } q \neq n$$

and, moreover, the cohomology group $H^n(X, Z; \mathbb{Z})$ is a free \mathbb{Z} -module.

We formulate the Lemma for coefficients in \mathbb{Z} , but by the universal coefficient theorem [Wei94, Theorem 3.6.4] it will hold with other coefficients as well.

Example 2.5.3. There is an example where there is an easy way to obtain Z . Assume that X is of the form $\bar{X} \setminus H$ for some smooth projective \bar{X} and a transversal hyperplane section $H \subset \bar{X}$ (with respect to a fixed embedding of \bar{X} into a projective space) and $W = \emptyset$. Then choose another transversal hyperplane section $H' \subset \bar{X}$ also meeting H transversally and put $Z := H' \cap X$. It follows from Corollary 2.3.17 of the Lefschetz hyperplane theorem that $H^q(X, Z; \mathbb{Z}) = 0$ for $q \leq n-1$. On the other hand, cohomology vanishes for $q > n$ by Artin vanishing, see Corollary 2.3.15, because X is affine. This argument will be generalised in two of the proofs below.

An inductive application of this Basic Lemma starting with the case $W = \emptyset$ yields a filtration of X by closed subsets

$$X = X_n \supset X_{n-1} \supset \cdots \supset X_0 \supset X_{-1} = \emptyset.$$

As in Corollary 2.3.13, this filtration induces a complex of free \mathbb{Z} -modules

$$\cdots \xrightarrow{\delta_{i-1}} H^i(X_i, X_{i-1}; \mathbb{Z}) \xrightarrow{\delta_i} H^{i+1}(X_{i+1}, X_i; \mathbb{Z}) \xrightarrow{\delta_{i+1}} \cdots,$$

where the maps δ_\bullet arise from the coboundary in the long exact sequence associated to the triples $X_{i+1} \supset X_i \supset X_{i-1}$, computing the cohomology of X .

Remark 2.5.4. This means that we can understand this filtration as an algebraic analogue of the skeletal filtration of (the topological realisation) of a simplicial set, see Corollary 2.3.13. Note that the filtration is not only algebraic, but even defined over the base field k .

The Basic Lemma is deduced from the following variant, which was also known to Beilinson [Bei87]. To state it, we need the notion of a (weakly) constructible sheaf, which omits the finite generation condition for the stalks of constructible sheaves. This is often useful.

Definition 2.5.5. A sheaf of abelian groups on a variety X over k is *weakly constructible* if there is a decomposition of X into a disjoint union of finitely many Zariski locally closed subsets Y_i defined over k , and such that the restriction of F to Y_i is locally constant. It is called *constructible* if, in addition, the stalks of F are finitely generated abelian groups. We call such a decomposition a *stratification* if in addition all strata $S = Y_i$ are smooth and connected.

Remark 2.5.6. This combination of sheaves in the analytic topology together with strata algebraic and defined over k is usually not discussed in the literature. In fact, the formalism works in the same way as with algebraic strata over \mathbb{C} . What we need are enough Whitney stratifications alge-

braic over k . That this is possible can be deduced from [Tei82, Théorème 1.2 p. 455] (characterisation of Whitney stratifications) and [Tei82, Proposition 2.1] (Whitney stratifications are generic).

Theorem 2.5.7 (Basic Lemma II). *Let X be an affine variety over k of dimension n and F be a weakly constructible sheaf on X . Then there exists a Zariski open subset $j : U \hookrightarrow X$ such that the following three properties hold:*

1. $\dim(X \setminus U) < n$.
2. $H^q(X, F') = 0$ for $q \neq n$, where $F' := j_!j^*F \subset F$.
3. If F is constructible then $H^n(X, F')$ is finitely generated.
4. If the stalks of F are torsion-free, then $H^n(X, F')$ is torsion-free.

In order to relate the two versions of the Basic Lemma, we will also need some basic facts about sheaf cohomology. If $j : U \hookrightarrow X$ is a Zariski open subset with closed complement $i : W \hookrightarrow X$ and F a sheaf of abelian groups on X , then there is an exact sequence of sheaves

$$0 \rightarrow j_!j^*F \rightarrow F \rightarrow i_*i^*F \rightarrow 0.$$

In addition, for the constant sheaf $F = \mathbb{Z}$ on X , one has $H^q(X, j_!j^*F) = H^q(X, W; \mathbb{Z})$ and $H^q(X, i_*i^*F) = H^q(W, \mathbb{Z})$, see Section 2.1.

Version II of the Lemma implies version I. Let $V = X \setminus W$ with open immersion $h : V \hookrightarrow X$, and the sheaf $F = h_!h^*\mathbb{Z}$ on X . Version II for F gives an open subset $\ell : U \hookrightarrow X$ such that the sheaf $F' = \ell_!\ell^*F$ has non-vanishing cohomology only in degree n . Let $W' = X \setminus U$. Since F was zero on W , we have that F' is zero on $Z := W \cup W'$ and it is the constant sheaf on $X \setminus Z$, i.e., $F' = j_!j^*F$ for $j : X \setminus Z \hookrightarrow X$. In particular, F' computes the relative cohomology $H^q(X, Z; \mathbb{Z})$ and it vanishes for $q \neq n$. Freeness follows from property (3) and (4). \square

We will give two proofs of the Basic Lemma II in Sections 2.5.3 and 2.5.4 below.

2.5.2 Direct proof of Basic Lemma I

We start by giving a direct proof of Basic Lemma I. It was given by Nori in the unpublished notes [Nora]. Close inspection shows that it is actually a variant of Beilinson's argument in this very special case.

Lemma 2.5.8. *Let X be affine and $W \subset X$ closed. Then there exist*

1. \tilde{X} smooth projective;
2. $D_0, D_\infty \subset \tilde{X}$ closed such that $D_0 \cup D_\infty$ is a simple normal crossings divisor and $\tilde{X} \setminus D_0$ is affine;

3. $\pi : \tilde{X} \setminus D_\infty \rightarrow X$ proper surjective, an isomorphism outside of D_0 such that $Y := \pi(D_0 \setminus D_\infty \cap D_0)$ contains W and $\pi^{-1}(Y) = D_0 \setminus D_\infty \cap D_0$.

Proof. By enlarging W , we may assume without loss of generality that $X \setminus W$ is smooth. Let \bar{X} be a projective closure of X and \bar{W} the closure of W in \bar{X} . By resolution of singularities, there is $\tilde{X} \rightarrow \bar{X}$ proper surjective and an isomorphism above $X \setminus W$ such that \tilde{X} is smooth. Let $D_\infty \subset \tilde{X}$ be the complement of the preimage of X . Let \tilde{W} be the closure of the preimage of W . By resolution of singularities, we can also assume that $\tilde{W} \cup D_\infty$ is a divisor with normal crossings.

Note that \bar{X} and hence also \tilde{X} are projective. We choose a generic hyperplane \tilde{H} such that $\tilde{W} \cup D_\infty \cup \tilde{H}$ is a divisor with normal crossings on \tilde{X} . This is possible as the ground field k is infinite and the condition is satisfied in a non-empty Zariski open subset of the space of hyperplane sections. We put $D_0 = \tilde{H} \cup \tilde{W}$. As \tilde{H} is a hyperplane section, it is an ample divisor. Therefore, $D_0 = \tilde{H} \cup \tilde{W}$ is the support of the ample divisor $\tilde{H} + m\tilde{W}$ for m sufficiently large [Har77, Exercise II 7.5(b)]. Hence $\tilde{X} \setminus D_0$ is affine, as the complement of an ample divisor in a projective variety is affine. \square

Proof of Basic Lemma I. We prove the Basic Lemma for cohomology with coefficients in a field K . We use the varieties constructed in the last lemma. We claim that Y has the right properties. We have $Y \supset W$. From Artin vanishing, see Corollary 2.3.15, we immediately have vanishing of $H^i(X, Y; K)$ for $i > n$.

By excision, see Proposition 2.1.8

$$H^i(X, Y; K) = H^i(\tilde{X} \setminus D_\infty, D_0 \setminus (D_0 \cap D_\infty); K).$$

By Poincaré duality for pairs, see Theorem 2.4.5, it is dual to

$$H^{2n-i}(\tilde{X} \setminus D_0, D_\infty \setminus (D_0 \cap D_\infty); K).$$

The variety $\tilde{X} \setminus D_0$ is affine. Hence, by Artin vanishing, the cohomology group $H^i(X, Y; K)$ vanishes for all $i \neq n$ and any coefficient field K .

It remains to treat the case of integral coefficients. Let i be the smallest index such that $H^i(X, Y; \mathbb{Z})$ is non-zero. By relative Artin vanishing for \mathbb{Z} -coefficients, see Corollary 2.3.15, we have $i \leq n$.

If $i < n$, then the group $H^i(X, Y; \mathbb{Z})$ has to be torsion because the cohomology vanishes with \mathbb{Q} -coefficients. The short exact sequence

$$0 \rightarrow \mathbb{Z} \xrightarrow{p} \mathbb{Z} \rightarrow \mathbb{F}_p \rightarrow 0$$

induces an exact sequence

$$0 \rightarrow H^{i-1}(X, Y; \mathbb{F}_p) \rightarrow H^i(X, Y; \mathbb{Z}) \xrightarrow{p} H^i(X, Y; \mathbb{Z})$$

which implies that $H^{i-1}(X, Y; \mathbb{F}_p)$ is non-trivial for the occurring torsion primes. This contradicts the vanishing for $K = \mathbb{F}_p$. Hence $i = n$. The same argument shows that $H^n(X, Y; \mathbb{Z})$ is torsion-free. \square

2.5.3 Nori's proof of Basic Lemma II

We now present the proof of the stronger Basic Lemma II published by Nori in [Nor02].

We start with a couple of lemmas on weakly constructible sheaves.

Lemma 2.5.9. *Let $0 \rightarrow F_1 \rightarrow F_2 \rightarrow F_3 \rightarrow 0$ be a short exact sequence of sheaves on X with F_1, F_3 (weakly) constructible. Then F_2 is (weakly) constructible.*

Proof. By assumption, there are stratifications of X such that F_1 and F_3 become locally constant, respectively. We take a common refinement. We replace X by one of the strata and are now in the situation that F_1 and F_3 are locally constant on a smooth connected variety. Then F_2 is also locally constant. Indeed, by passing to a suitable open cover (in the analytic topology), F_1 and F_3 even become constant. We restrict to a contractible open U , which exists because X^{an} is locally contractible. If $V \subset U$ is an inclusion of an open connected subset, then the restrictions $F_1(U) \rightarrow F_1(V)$ and $F_3(U) \rightarrow F_3(V)$ are isomorphisms. This implies the same statement for F_2 , because $H^1(U, F_1) = 0$, as constant sheaves do not have higher cohomology on contractible sets. \square

Lemma 2.5.10. *The notion of (weak) constructibility is stable under $j_!$ for j an open immersion and π_* for π finite.*

Proof. The assertion for $j_!$ is obvious. The same holds for i_* in the case of closed immersions.

Now assume $\pi : X \rightarrow Y$ is finite and in addition étale. Let F be (weakly) constructible on X . Let $X_0, \dots, X_n \subset X$ be a stratification such that $F|_{X_i}$ is locally constant. Let Y_i be the image of X_i . These are locally closed subvarieties of Y because π is closed and open. We refine them into a stratification of Y . As π is finite étale, it is locally in the analytic topology of the form $I \times B$ with I finite and $B \subset Y(\mathbb{C})$ an open set in the analytic topology. Obviously $\pi_* F|_B$ is locally constant on the strata we have defined.

Now let π be finite. As we have already discussed closed immersions, it suffices to assume that π is surjective. There is an open dense subscheme $U \subset Y$ such that π is étale above U . Let $U' = \pi^{-1}(U)$, $Z = Y \setminus U$ and $Z' = X \setminus U'$. We consider the exact sequence on X

$$0 \rightarrow j_{U'!} j_{U'}^* F \rightarrow F \rightarrow i_{Z'*} i_{Z'}^* F \rightarrow 0.$$

As π is finite, the functor π_* is exact and hence

$$0 \rightarrow \pi_* j_{U'}! j_{U'}^* F \rightarrow \pi_* F \rightarrow \pi_* i_{Z'}! i_{Z'}^* F \rightarrow 0.$$

By Lemma 2.5.9, it suffices to consider the outer terms. We have

$$\pi_* j_{U'}! j_{U'}^* F = j_{U'}! \pi|_{U'} j_{U'}^* F,$$

and this is (weakly) constructible by the étale case and the assertion on open immersions. We also have

$$\pi_* i_{Z'}! i_{Z'}^* F = i_{Z'}! \pi|_{Z'} i_{Z'}^* F,$$

and this is (weakly) constructible by noetherian induction and the case of closed immersions. \square

Nori's proof of Basic Lemma II. The argument will show a more precise version of property (3) and (4): there exists a finite subset $E \subset U(\mathbb{C})$ such that $H^{\dim(X)}(X, F')$ is isomorphic to a direct sum $\bigoplus_x F_x$ of stalks of F at points of E .

Let $n := \dim(X)$. In the first step, we reduce to $X = \mathbb{A}^n$. We use Noether normalisation to obtain a finite morphism $\pi : X \rightarrow \mathbb{A}^n$. By Lemma 2.5.10, the sheaf $\pi_* F$ is (weakly) constructible.

Let then $v : V \hookrightarrow \mathbb{A}^n$ be a Zariski open set with the property that $F' := v_! v^* \pi_* F$ satisfies the Basic Lemma II on \mathbb{A}^n . Let $U := \pi^{-1}(V) \xrightarrow{j} X$ be the preimage in X . One has an isomorphism of sheaves:

$$\pi_* j_! j^* F \cong v_! v^* \pi_* F.$$

Therefore, $H^q(X, j_! j^* F) \cong H^q(\mathbb{A}^n, v_! v^* \pi_* F)$ for all q and the latter vanishes for $q < n$. The formula for the n -cohomology on \mathbb{A}^n implies the one on X .

So let us now assume that F is weakly constructible on $X = \mathbb{A}^n$. We argue by induction on n and all F . The case $n = 0$ is trivial.

By replacing F by $j_! j^* F$ for an appropriate open $j : U \rightarrow \mathbb{A}^n$, we may assume that F is locally constant on U and that $\mathbb{A}^n \setminus U = V(f)$. By Noether normalisation or its proof, there is a surjective projection map $\pi : \mathbb{A}^n \rightarrow \mathbb{A}^{n-1}$ such that $\pi|_{V(f)} : V(f) \rightarrow \mathbb{A}^{n-1}$ is surjective and finite.

We will see in Lemma 2.5.11 that $R^q \pi_* F = 0$ for $q \neq 1$ and $R^1 \pi_* F$ is weakly constructible. The Leray spectral sequence now gives that

$$H^q(\mathbb{A}^n, F) = H^{q-1}(\mathbb{A}^{n-1}, R^1 \pi_* F).$$

In the induction procedure, we apply the Basic Lemma II to $R^1 \pi_* F$ on \mathbb{A}^{n-1} . By induction, there exists a Zariski open $h : V \hookrightarrow \mathbb{A}^{n-1}$ such that $h_! h^* R^1 \pi_* F$ has cohomology only in degree $n - 1$. Let $U := \pi^{-1}(V)$ and $j : U \hookrightarrow \mathbb{A}^n$ be the inclusion. Then $j_! j^* F$ has cohomology only in degree n . The explicit

description of cohomology in degree n follows from the description of the stalks of $R^1\pi_*F$ in the proof of Lemma 2.5.11. \square

Lemma 2.5.11. *Let $\pi : \mathbb{A}^n \rightarrow \mathbb{A}^{n-1}$ be a coordinate projection. Let $V(f) \subset \mathbb{A}^n$ such that $\pi|_{V(f)}$ is finite surjective. Let F on \mathbb{A}^n be locally constant on $U = \mathbb{A}^n \setminus V(f)$ and vanish on $V(f)$.*

*Then $R^q\pi_*F = 0$ for $q \neq 1$ and $R^1\pi_*F$ is weakly constructible. Moreover, for every $y \in \mathbb{A}^{n-1}(\mathbb{C})$ there is a finite set $E \subset \pi^{-1}(y)$ such that $(R^1\pi_*F)_y = \bigoplus_{e \in E} F_e$.*

Proof. This is a standard fact, but Nori gives a direct proof.

The stalk of $R^q\pi_*F$ at $y \in \mathbb{A}^{n-1}$ is given by $H^q(\{y\} \times \mathbb{A}^1, F|_{\{y\} \times \mathbb{A}^1})$ by the variation of proper base change in Theorem 2.5.12 below.

Let, more generally, G be a sheaf on \mathbb{A}^1 which is locally constant outside a finite, non-empty set S where it vanishes. Let T be a finite embedded tree in $\mathbb{A}^1(\mathbb{C}) = \mathbb{C}$ with vertex set S . Then the restriction map to the tree defines a retraction isomorphism $H^q(\mathbb{A}^1, G) \cong H^q(T, G_T)$ for all $q \geq 0$. Using Čech cohomology, we can compute $H^q(T, G_T)$: for each vertex $v \in S$, let U_v be the open star of all outgoing half open edges at the vertex v . Then U_a and U_b only intersect if the vertices a and b have a common edge $e = e(a, b)$. The intersection $U_a \cap U_b$ is contractible and contains the center $t(e)$ of the edge e . There are no triple intersections. Hence $H^q(T, G_T) = 0$ for $q \geq 2$. We have $G(U_s) = 0$ because G is zero on S , locally constant away from S and U_s is simply connected. Therefore also $H^0(T, G_T) = 0$ and $H^1(T, G_T)$ is isomorphic to $\bigoplus_e G_{t(e)}$.

This implies already that $R^q\pi_*F = 0$ for $q \neq 1$.

To show that $R^1\pi_*F$ is weakly constructible means to show that it is locally constant on some stratification. We see that the stalks $(R^1\pi_*F)_y$ depend only on the set of points in $\{y\} \times \mathbb{A}^1 = \pi^{-1}(y)$ where $F|_{\{y\} \times \mathbb{A}^1}$ vanishes. But the sets of points where the vanishing set has the same degree (cardinality) defines a suitable stratification. Note that the stratification only depends on the branching behaviour of $V(f) \rightarrow \mathbb{A}^{n-1}$, hence the stratification is algebraic and defined over k . \square

Theorem 2.5.12 (Variation of Proper Base Change). *Let $\pi : X \rightarrow Y$ be a continuous map between locally compact, locally contractible topological spaces which is a fibre bundle and let G be a sheaf on X . Assume $W \subset X$ is closed and such that G is locally constant on $X \setminus W$ and π restricted to W is proper. Then $(R^q\pi_*G)_y \cong H^q(\pi^{-1}(y), G_{\pi^{-1}(y)})$ for all q and all $y \in Y$.*

Proof. The statement is local on Y , so we may assume that $X = T \times Y$ is a product with π the projection. Since Y is locally compact and locally contractible, we may assume that Y is compact by passing to a compact neighbourhood of y . As $W \rightarrow Y$ is proper, this implies that W is compact. By enlarging W , we may assume that $W = K \times Y$ is a product of compact sets for some compact subset $K \subset T$. Since Y is locally contractible, we

replace Y by a contractible neighbourhood. (We may lose compactness, but this does not matter any more.) Let $i : K \times Y \rightarrow X$ be the inclusion and $j : (T \setminus K) \times Y \rightarrow X$ the complement.

Look at the exact sequence

$$0 \rightarrow j_!G_{(T \setminus K) \times Y} \rightarrow G \rightarrow i_*G_{K \times Y} \rightarrow 0.$$

The result holds for $G_{K \times Y}$ by the usual proper base change, see [KS90, Proposition 2.5.2].

Since Y is contractible, we may assume that $G_{(T \setminus K) \times Y}$ is the pull-back of the constant sheaf on $T \setminus K$. Now the result for $j_!G_{(T \setminus K) \times Y}$ follows from the Künneth formula. \square

2.5.4 Beilinson's proof of Basic Lemma II

We follow Beilinson [Bei87, Proof 3.3.1], who even proves a more general result. Note that Beilinson works in the setting of étale sheaves, independent of the characteristic of the ground field. We have translated it to weakly constructible sheaves. The argument is intrinsically about perverse sheaves, and the perverse t -structure, even though we have downplayed their use as far as possible. For an extremely short introduction, see Section 2.5.5.

Let X be affine and reduced of dimension n over a field $k \subset \mathbb{C}$. Let F be a (weakly) constructible sheaf on X . We choose a projective compactification $\kappa : X \hookrightarrow \bar{X}$ such that κ is an affine morphism. Let W be a divisor on X such that F is a locally constant sheaf on $X \setminus W$ and $X \setminus W$ is smooth. Let $h : X \setminus W \hookrightarrow X$ be the open immersion. Then define $M := h_!h^*F$.

Let $\bar{H} \subset \bar{X}$ be a generic hyperplane. We will see in the proof of Lemma 2.5.13 below what the conditions on \bar{H} are. Let $H = X \cap \bar{H}$ be the corresponding hyperplane in X .

We denote by $V = \bar{X} \setminus \bar{H}$ the complement and by $\ell : V \hookrightarrow \bar{X}$ the open inclusion. Furthermore, let $\kappa_V : V \cap X \hookrightarrow V$ and $\ell_X : V \cap X \hookrightarrow X$ be the open inclusion maps, and $i : \bar{H} \hookrightarrow \bar{X}$ and $i_X : H \hookrightarrow X$ the closed immersions. We set $U := X \setminus (W \cup H)$ and consider the open inclusion $j : U \hookrightarrow X$ with complement $Z = W \cup H$. Let $M_{V \cap X}$ be the restriction of M to $V \cap X$. Summarising, we have a commutative diagram

$$\begin{array}{ccccc} & & U & & \\ & & \downarrow j & & \\ V \cap X & \xrightarrow{\ell_X} & X & \xleftarrow{i_X} & H \\ \kappa_V \downarrow & & \downarrow \kappa & & \downarrow \tilde{\kappa} \\ V & \xrightarrow{\ell} & \bar{X} & \xleftarrow{i} & \bar{H}. \end{array}$$

Lemma 2.5.13. *For generic \bar{H} in the above set-up, there is an isomorphism*

$$\ell_! \ell^* R\kappa_* M \xrightarrow{\cong} R\kappa_! \ell_{X^*} M_{V \cap X}$$

extending naturally $\text{id} : M_{V \cap X} \rightarrow M_{V \cap X}$.

Proof. We consider the map of distinguished triangles

$$\begin{array}{ccccc} \ell_! \ell^* R\kappa_* M & \longrightarrow & R\kappa_* M & \longrightarrow & i_* i^* R\kappa_* M \\ \downarrow & & \text{id} \downarrow & & \downarrow \\ R\kappa_* \ell_{X^*} M_{V \cap X} & \longrightarrow & R\kappa_* M & \longrightarrow & i_* R\tilde{\kappa}_* i_X^* M \end{array}$$

The existence of the arrows follows from standard adjunctions together with proper base change in the simple formulas $\kappa^* \ell_! \cong \ell_{X^*} \kappa_V^*$ and $\kappa^* i_* \cong i_{X^*} \tilde{\kappa}^*$, respectively.

Hence it is sufficient to prove that

$$i^* R\kappa_* M \xrightarrow{\cong} R\tilde{\kappa}_* i_X^* M. \quad (2.1)$$

To prove this, we make a base change to the universal hyperplane section. In detail: Let \mathbb{P} be the space of hyperplanes in \bar{X} . Let

$$\bar{\mathcal{H}}_{\mathbb{P}} \rightarrow \mathbb{P}$$

be the universal family. It comes with a natural map

$$i_{\mathbb{P}} : \bar{\mathcal{H}}_{\mathbb{P}} \rightarrow \bar{X}.$$

By [Gro, p. 9] and [Jou83, Théorème 6.10] there is a dense Zariski open subset $T \subset \mathbb{P}$ such that the induced map

$$i_T : \bar{\mathcal{H}}_T \hookrightarrow \bar{X} \times T \longrightarrow \bar{X}$$

is smooth. Let \mathcal{H}_T be the preimage of X .

We apply a smooth base change in the square

$$\begin{array}{ccc} \mathcal{H}_T & \xrightarrow{i_{X,T}} & X \\ \bar{\kappa}_T \downarrow & & \downarrow \kappa \\ \bar{\mathcal{H}}_T & \xrightarrow{i_T} & \bar{X} \end{array}$$

and obtain a quasi-isomorphism

$$i_T^* R\kappa_* M \xrightarrow{\cong} R\tilde{\kappa}_{T^*} i_{X,T}^* M$$

of complexes of sheaves on $\bar{\mathcal{H}}_T$.

We specialise to some $t \in T(k)$ and get a hyperplane $t : \bar{H} \subset \bar{\mathcal{H}}_T$ to which we restrict. The left-hand side turns into $i^* R\kappa_* M$.

We apply the generic base change theorem 2.5.14 to $\bar{\kappa}_T$ over the base T and $\mathcal{G} = i_{X,T}^* M$. Hence after shrinking T further, the right-hand side turns into

$$t^* R\bar{\kappa}_{T*} i_{X,T}^* M \cong R\bar{\kappa}_* t_X^* i_{X,T}^* M \cong R\bar{\kappa} i_X^* M.$$

Putting these equations together, we have verified equation 2.1. \square

Proof of Basic Lemma II. We keep the notation fixed at the beginning of the present Subsection 2.5.4. Let $\bar{H} \subset \bar{X}$ be a generic hyperplane in the sense of Lemma 2.5.13.

By Artin vanishing for constructible sheaves (see Theorem 2.5.23), the group $H^i(X, j_! j^* F)$ vanishes for $i > n$. It remains to show that $H^i(X, j_! j^* F)$ vanishes for $i < n$. We obviously have $j_! j^* F \cong \ell_{X!} M_{V \cap X}$. Therefore,

$$\begin{aligned} H^i(X, j_! j^* F) &\cong H^i(X, \ell_{X!} M_{V \cap X}) \\ &\cong H^i(\bar{X}, R\kappa_* \ell_{X!} M_{V \cap X}) \\ &\cong H^i(\bar{X}, \ell_! \ell^* R\kappa_* M) \quad \text{by 2.5.13} \\ &= H_c^i(V, (R\kappa_* M)_V). \end{aligned}$$

The last group vanishes for $i < n$ by Artin's vanishing theorem 2.5.23 for compact supports once we have checked that $R\kappa_* M_V[n]$ is perverse for the middle perversity, see Definition 2.5.21. Recall that $M = h_! h^* F$. The restriction $F|_{X \setminus W}$ is a locally constant sheaf and $X \setminus W$ smooth. Hence $F|_{X \setminus W}[n]$ is perverse. Both h and κ are affine, hence the same is true for $R\kappa_* h_! F|_{X \setminus W}[n]$ by Theorem 2.5.23 (3).

If, in addition, F is constructible, then by the same theorem, the complex $R\kappa_* h_! F|_{X \setminus W}[n]$ is in $D_c^{\geq 0}(X)$. Hence our cohomology with compact support is also finitely generated.

If the stalks of F are torsion-free, then by the same theorem $R\kappa_* h_! F|_{X \setminus W}$ is in ${}^+ D_{\bar{w}c}^{\geq n}(X)$. Hence $H_c^n(X, R\kappa_* h_! F|_{X \setminus W})$ is torsion-free as well. \square

Theorem 2.5.14 (Generic base change). *Let S be a separated scheme of finite type over k and $f : X \rightarrow Y$ a morphism of separated S -schemes of finite type over S . Let \mathcal{F} be a (weakly) constructible sheaf on X . Then there is a dense open subset $U \subset S$ such that:*

1. *over U , the sheaves $R^i f_* \mathcal{F}$ are (weakly) constructible and vanish for almost all i ;*
2. *the formation of $R^i f_* \mathcal{F}$ is compatible with any base change $S' \rightarrow U \subset S$.*

This is the analogue of [Del77, Théorème 1.9 in sect. Thm. finitude], which is for constructible étale sheaves in the étale setting.

Proof. The case $S = Y$ was treated by Arapura, see [Ara13, Theorem 3.1.10]. We explain the reduction to this case, using the same arguments as in the étale case.

All schemes can be assumed reduced.

Using Nagata, we can factor f as a composition of an open immersion and a proper map. The assertion holds for the latter by the proper base change theorem, hence it suffices to consider open immersions.

As the question is local on Y , we may assume that it is affine over S . We can then cover X by affines. Using the hypercohomology spectral sequence for the covering, we may reduce to the case when X is affine. In this case (X and Y affine, f an open immersion) we argue by induction on the dimension of the generic fibre of $X \rightarrow S$.

If $n = 0$, then, at least after shrinking S , we are in the situation where f is the inclusion of a connected component and the assertion is trivial.

We now assume the case $n - 1$. We embed Y into \mathbb{A}_S^m and consider the coordinate projections $p_i : Y \rightarrow \mathbb{A}_S^1$. We apply the inductive hypothesis to the map f over \mathbb{A}_S^1 . Hence there is an open dense $U_i \subset \mathbb{A}_S^1$ such that the conclusion is valid over $p^{-1}U_i$. Hence the conclusion is valid over their union, i.e., outside a closed subvariety $Y_1 \subset Y$ finite over S . By shrinking S , we may assume that it is finite étale.

We fix the notation in the resulting diagram as follows:

$$\begin{array}{ccccc} X & \xrightarrow{f} & Y & \xleftarrow{i} & Y_1 \\ & \searrow a & \downarrow b & \swarrow b_1 & \\ & & S & & \end{array}$$

Let j be the open complement of i . We have checked that $j^*Rf_*\mathcal{G}$ is (weakly) constructible and compatible with any base change. We apply Rb_* to the triangle defined by the sequence

$$j_!j^*Rf_*\mathcal{G} \rightarrow Rf_*\mathcal{G} \rightarrow i_*i^*Rf_*\mathcal{G}$$

and obtain

$$Rb_*j_!j^*Rf_*\mathcal{G} \rightarrow Ra_*\mathcal{G} \rightarrow b_{1*}i^*Rf_*\mathcal{G}.$$

The first two terms are (possibly after shrinking S) (weakly) constructible by the previous considerations and the case $S = Y$. We also obtain that they are compatible with any base change. Hence the same is true for the third term. As b_1 is finite étale this also implies that $i^*Rf_*\mathcal{G}$ is (weakly) constructible and compatible with base change. Indeed, this follows because a direct sum of sheaves is constant if and only if every summand is constant. The same is true for $j_!j^*Rf_*\mathcal{G}$ by the previous considerations and base change for $j_!$. Hence the conclusion also holds for the middle term of the first triangle and we are done. \square

2.5.5 Perverse sheaves and Artin vanishing

We clarify the setting used in Beilinson's proof of the Basic Lemma II above. Our aim is to formulate and prove the version of Artin vanishing that we need. Note that the notion of a perverse sheaf and the perverse t -structure is *not* needed for this purpose. We choose to explain the notion anyway because this is the real story behind the story. For a complete introduction to the theory of perverse sheaves, see the original reference [BBD82] by Beilinson, Bernstein and Deligne. For the more specific aspects we refer to Schürmann's monograph [Sch03].

Definition 2.5.15 ([BBD82, Définition 1.3.1]). Let D be a triangulated category. A t -structure on D consists of a pair $(D^{\leq 0}, D^{\geq 0})$ of full subcategories such that

1. $D^{\leq -1} := D^{\leq 0}[1] \subset D^{\leq 0}$, $D^{\geq 1} := D^{\geq 0}[-1] \subset D^{\geq 0}$,
2. $\mathrm{Hom}_D(X, Y) = 0$ for all $X \in D^{\leq 0}, Y \in D^{\geq 1}$,
3. for any object $X \in D$ there is a distinguished triangle

$$X^{\leq 0} \rightarrow X \rightarrow X^{\geq 1} \rightarrow X^{\leq 0}[1]$$

with $X^{\leq 0} \in D^{\leq 0}$, $X^{\geq 1} \in D^{\geq 1}$.

We call $\mathcal{A} = D^{\leq 0} \cap D^{\geq 0}$ the *heart* of the t -structure. For $n \in \mathbb{Z}$ we put

$$D^{\leq n} = D^{\leq 0}[-n], D^{\geq n} = D^{\geq 0}[-n].$$

Example 2.5.16. Let \mathcal{A} be an abelian category and $D = D(\mathcal{A})$ its derived category. We put $D^{\leq 0}$ and $D^{\geq 0}$ the subcategory with objects concentrated in non-positive and non-negative degrees, respectively. This is a t -structure with heart \mathcal{A} . Indeed, the axioms mimic the properties of this example.

Example 2.5.17 ([BBD82, Section 3.3], [Sch03, Example 6.0.2. 3., p. 378]). Let $D(\mathbb{Z})$ be the derived category of abelian groups. Let ${}^+D^{\leq 0}$ be the subcategory of complexes K^\bullet such that $H^i(K^\bullet)$ vanishes for $i \geq 2$ and is torsion for $i = 1$. Let ${}^+D^{\geq 0}$ be the subcategory of complexes K^\bullet such that $H^i(K^\bullet)$ vanishes for $i < 0$ and is torsion-free for $i = 0$. Then $({}^+D^{\leq 0}, {}^+D^{\geq 0})$ is a t -structure, because $\mathrm{Hom}(T, F) = 0$ for any torsion group T and F torsion-free.

Theorem 2.5.18 ([BBD82, Théorème 1.3.6]). *The heart of a t -structure is an abelian category.*

Probably the best-known non-trivial example is the following:

Example 2.5.19 ([BBD82, Section 2.1 and 2.2]). Let $\pi : X \rightarrow \mathbb{C}$ be an algebraic variety. Let $\mathcal{S}(X^{\mathrm{an}}, \mathbb{Z})$ be the category of abelian sheaves on X^{an} and let

$$D_c^b(X, \mathbb{Z}) \subset D(\mathcal{S}(X^{\mathrm{an}}, \mathbb{Q}))$$

be the subcategory of complexes whose cohomology objects are all constructible, see Definition 2.5.5, and almost all zero. Then we obtain a t -structure as follows:

- The full subcategory $D^{\leq 0}(X)$ is given by the complexes \mathcal{F}^\bullet such that there is a stratification of X such that for the inclusion $i_S : S \rightarrow X$ of a stratum the sheaves $H^i i_S^* \mathcal{F}^\bullet$ are locally constant and vanish for $i > -\dim_{\mathbb{C}} S$.
- The full subcategory $D^{\geq 0}(X)$ is given by the complexes \mathcal{F}^\bullet such that there is a stratification of X such that for the inclusion $i_S : S \rightarrow X$ of a stratum the sheaves $H^i i_S^! \mathcal{F}^\bullet$ are locally constant and vanish for $i < -\dim_{\mathbb{C}} S$.

It goes by the name of the t -structure for the *middle perversity*. Its heart is called the category of *perverse sheaves* (for the middle perversity). If X is smooth, then a locally constant sheaf of finitely generated abelian groups viewed as a complex concentrated in degree $-\dim X$ is a perverse sheaf.

Recall from Definition 2.5.5 that the strata of stratification are assumed algebraic and in addition smooth and connected.

We have been working in a more general setting: Let $k \subset \mathbb{C}$ be a subfield, X an algebraic variety over k . Let $\mathcal{S}(X^{\text{an}}, \mathbb{Z})$ be the category of sheaves of abelian groups on X^{an} .

Definition 2.5.20. Let X and $\mathcal{S}(X^{\text{an}}, \mathbb{Z})$ be as just defined.

1. Let

$$D_{wc}(X, \mathbb{Z}) \subset D(\mathcal{S}(X^{\text{an}}, \mathbb{Z}))$$

be the full subcategory of complexes such that there is a stratification of X by locally closed algebraic subvarieties over k such that the restriction of the cohomology sheaves whose cohomology objects are weakly constructible with respect to this stratification, see Definition 2.5.5.

2. Let

$$D_c^b(X, \mathbb{Z}) \subset D(\mathcal{S}(X^{\text{an}}, \mathbb{Z}))$$

be the full subcategory of complexes whose cohomology objects are constructible and almost all zero.

Note that the condition on objects of $D_{wc}(X, \mathbb{Z})$ is stronger than the assumption that all cohomology sheaves are weakly constructible.

The six functor formalism is available in these settings by [Sch03, Proposition 4.0.2 on p. 214 and Proposition 6.0.1 on p. 379]. The necessary properties of the stratifications by algebraic subvarieties over k hold, see Remark 2.5.6. It turns out that there are two choices of t -structure for the middle perversity on $D_{wc}(X, \mathbb{Z})$ and $D_c^b(X, \mathbb{Z})$, the standard one and one based on Example 2.5.17.

Definition 2.5.21. 1. Let $D_{wc}^{\leq 0}(X)$ and $D_{wc}^{\geq 0}(X)$ be the subcategories of $D_{wc}(X, \mathbb{Z})$ defined by the same condition as in Example 2.5.19 but with strata defined over k .

2. Let ${}^+D_{wc}^{\leq 0}(X)$ be the full subcategory of $D_{wc}(X, \mathbb{Z})$ that contains the complexes \mathcal{F}^\bullet such that there is a sufficiently fine stratification of X by locally

closed algebraic strata such that for the inclusion $i_S : S \rightarrow X$ of a stratum the sheaves $H^i i_S^* \mathcal{F}^\bullet$ are locally constant and for some (and hence every) point $x \in S$ with inclusion $i_x : s \rightarrow S$

$$i_x^* i_S^* \mathcal{F}^\bullet[-\dim_{\mathbb{C}} S] \in {}^+D^{\leq 0}(\mathbb{Z}).$$

3. Let ${}^+D_{wc}^{\geq 0}(X)$ be the full subcategory of $D_{wc}(X, \mathbb{Z})$ that contains the complexes \mathcal{F}^\bullet such that there is a sufficiently fine stratification of X by locally closed algebraic strata such that for the inclusion $i_S : S \rightarrow X$ of a stratum the sheaves $H^i i_S^! \mathcal{F}^\bullet$ are locally constant and for some (and hence every) point $x \in S$ with inclusion $i_x : x \rightarrow S$

$$i_x^* i_S^! \mathcal{F}^\bullet[-\dim_{\mathbb{C}} S] \in {}^+D^{\geq 0}(\mathbb{Z}).$$

4. Let $D_c^{\leq 0}(X) = D_{wc}^{\leq 0}(X) \cap D_c^b(X, \mathbb{Z})(X)$ and analogously for the other cases.

In any of these settings, we call the intersection ${}^?D_{\tilde{?}}^{\leq 0}(X) \cap {}^?D_{\tilde{?}}^{\geq 0}(X)$ the category of *perverse sheaves*.

Remark 2.5.22. It is not hard to deduce from the stability results of Schürmann in [Sch03, Section 6.0.1] and the methods of [BBD82, Chapter 2 and Section 3.3] that the pairs $({}^?D_{\tilde{?}}^{\leq 0}(X), {}^?D_{\tilde{?}}^{\geq 0}(X))$ define a t -structure in each of the four cases above. However, we are not going to give details because we are not aware of a readably available reference and we do not need these facts.

If X is an algebraic variety over k , and $j : X \hookrightarrow \bar{X}$ an arbitrary compactification, then cohomology with supports with coefficients in a weakly constructible sheaf \mathcal{G} is defined by

$$H_c^i(X, \mathcal{G}) := H^i(\bar{X}, j_! \mathcal{G}).$$

It follows from proper base change that this is independent of the choice of compactification.

Theorem 2.5.23 (Schürmann, Artin vanishing for weakly constructible sheaves). *Let X be a variety over $k \subset \mathbb{C}$.*

1. *Let X be affine of dimension n . Let \mathcal{G} be weakly constructible on X . Then $H^q(X, \mathcal{G}) = 0$ for $q > n$;*
2. *Let X be affine of dimension n . Let \mathcal{F}^\bullet be a perverse sheaf on X . Then $H_c^q(X, \mathcal{F}^\bullet) = 0$ for $q < 0$.*

More precisely, if \mathcal{F}^\bullet is an object of the category $D_{wc}^{\geq 0}(X)$, or $D_c^{\geq 0}(X)$, or ${}^+D_{wc}^{\geq 0}(X)$, or ${}^+D_c^{\geq 0}(X)$, then the complex $R\Gamma_c(X, \mathcal{F}^\bullet)$ computing cohomology with compact support also belongs to $D_{wc}^{\geq 0}(pt)$, or $D_c^{\geq 0}(pt)$, or ${}^+D_{wc}^{\geq 0}(pt)$, or ${}^+D_c^{\geq 0}(pt)$, respectively. This means it vanishes in negative degrees, or is bounded with finitely generated cohomology, or also has torsion-free H^0 , or all of this together, respectively.

3. Let X be a variety over k , $g : U \rightarrow X$ an affine open immersion and \mathcal{F}_\bullet a perverse sheaf on U . Then both $g_! \mathcal{F}_\bullet$ and $Rg_* \mathcal{F}_\bullet$ are perverse on X .

The word perverse refers to any of the four settings of Definition 2.5.21.

Proof. The first two statements are [Sch03, Corollary 6.0.4, p. 391]. Note that a weakly constructible sheaf lies in ${}^m D^{\leq n}(X)$ in the notation of loc. cit.

The last statement combines the vanishing results for affine morphisms [Sch03, Theorem 6.0.4, p. 409] with the standard vanishing for all compactifiable morphisms [Sch03, Corollary 6.0.5, p. 397] for a morphism of relative dimension 0.

The way the theory in [Sch03] is set up, it holds relative to a choice of a suitable subcategory B of the subcategory of the derived category of abelian groups, e.g. $B = {}^+ D_{\bar{\tau}}^{\leq 0}$ or $B = {}^? D_{\bar{\tau}}^{\leq 0}$, see [Sch03, Example 6.0.2, p. 388]. Hence we get all versions of Artin vanishing in parallel. \square

Example 2.5.24. Let X be a variety over k and let $j : U \subset X$ a smooth open subvariety, equidimensional of dimension d . Assume that j is affine. Let \mathcal{F} be a locally constant sheaf of U^{an} . We consider

$$j_! \mathcal{F}[d], Rj_* \mathcal{F}[d].$$

1. These complexes are in $D_{\bar{w}_c}^{\leq 0}(X) \cap D_{\bar{w}_c}^{\geq 0}(X)$.
2. If the stalks of \mathcal{F} are finitely generated, then these complexes are even in $D_{\bar{c}}^{\leq 0}(X) \cap D_{\bar{c}}^{\geq 0}(X)$.
3. If the stalks are torsion-free, these complexes are in ${}^+ D_{\bar{w}_c}^{\leq 0}(X) \cap {}^+ D_{\bar{w}_c}^{\geq 0}(X)$.
4. If the stalks are finitely generated and torsion-free, then these complexes are even in ${}^+ D_{\bar{c}}^{\leq 0}(X) \cap {}^+ D_{\bar{c}}^{\geq 0}(X)$.

Proof. We have $\mathcal{F}[d] \in {}^+ D_{\bar{\tau}}^{\leq 0}(U) \cap {}^+ D_{\bar{\tau}}^{\geq 0}(U)$. We then apply Theorem 2.5.23 \square

2.6 Triangulation of algebraic varieties

If X is a variety defined over \mathbb{Q} , we may ask whether any singular homology class $\gamma \in H_*^{\text{sing}}(X^{\text{an}}; \mathbb{Q})$ can be represented by an object described by polynomials. This is indeed the case. For a precise statement we need several definitions. The result will be formulated in Proposition 2.6.9.

This section follows closely the Diploma thesis of Benjamin Friedrich, see [Fri04]. The results are due to him.

Let $\mathbb{K} \subset \mathbb{R}$ be a subfield. We are mostly interested in the cases $\mathbb{K} = \mathbb{Q}$ and $\mathbb{K} = \tilde{\mathbb{Q}}$ where $\tilde{\mathbb{Q}}$ is the integral closure of \mathbb{Q} in \mathbb{R} . Note that $\tilde{\mathbb{Q}}$ is a field.

In this section, we use X to denote a variety over $\tilde{\mathbb{Q}}$, and X^{an} for the associated analytic space over \mathbb{C} (cf. Subsection 1.2.1).

2.6.1 Semi-algebraic Sets

Definition 2.6.1 ([Hir75, Definition 1.1., p.166]). Let $\mathbb{K} \subset \mathbb{R}$ be a subfield. A subset of \mathbb{R}^n is said to be \mathbb{K} -semi-algebraic if it is of the form

$$\{\underline{x} \in \mathbb{R}^n \mid f(\underline{x}) \geq 0\}$$

for some polynomial $f \in \mathbb{K}[x_1, \dots, x_n]$, or can be obtained from sets of this form in a finite number of steps, where each step consists of one of the following basic operations:

1. complementary set,
2. finite intersection,
3. finite union.

A \mathbb{K} -semi-algebraic set is called *bounded* if it is bounded as a subset of \mathbb{R}^n .

As the name suggests, any algebraic set should in particular be $\tilde{\mathbb{Q}}$ -semi-algebraic. We also need a definition for maps:

Definition 2.6.2 (\mathbb{K} -semi-algebraic map [Hir75, p. 168]). Let $\mathbb{K} \subset \mathbb{R}$ be a subfield. A continuous map f between \mathbb{K} -semi-algebraic sets $A \subseteq \mathbb{R}^n$ and $B \subseteq \mathbb{R}^m$ is said to be \mathbb{K} -semi-algebraic if its graph

$$\Gamma_f := \{(a, f(a)) \mid a \in A\} \subseteq A \times B \subseteq \mathbb{R}^{n+m}$$

is \mathbb{K} -semi-algebraic.

Example 2.6.3. Any polynomial map

$$\begin{aligned} f : A &\longrightarrow B \\ (a_1, \dots, a_n) &\mapsto (f_1(a_1, \dots, a_n), \dots, f_m(a_1, \dots, a_n)) \end{aligned}$$

between \mathbb{K} -semi-algebraic sets $A \subseteq \mathbb{R}^n$ and $B \subseteq \mathbb{R}^m$ with $f_i \in \mathbb{K}[x_1, \dots, x_n]$ for $i = 1, \dots, m$ is \mathbb{K} -semi-algebraic, since it is continuous and its graph $\Gamma_f \subseteq \mathbb{R}^{n+m}$ is cut out from $A \times B$ by the polynomials

$$y_i - f_i(x_1, \dots, x_n) \in \tilde{\mathbb{Q}}[x_1, \dots, x_n, y_1, \dots, y_m] \quad \text{for } i = 1, \dots, m. \quad (2.2)$$

We can even allow f to be a rational map with rational component functions

$$f_i \in \mathbb{K}(x_1, \dots, x_n), \quad i = 1, \dots, m$$

as long as none of the denominators of the f_i vanish at a point of A . The argument remains the same except that the expression (2.2) has to be multiplied by the denominator of f_i .

Fact 2.6.4 (Tarski–Seidenberg). *The image (respectively preimage) of a $\tilde{\mathbb{Q}}$ -semi-algebraic set under a $\tilde{\mathbb{Q}}$ -semi-algebraic map is again $\tilde{\mathbb{Q}}$ -semi-algebraic.*

The same holds for the image of a \mathbb{Q} -semi-algebraic set under a \mathbb{Q} -semi-algebraic map.

Proof. Historically, this was first observed by Tarski. A proof over \mathbb{R} can be found in [Hir75, Proposition II, p. 167]. A proof over \mathbb{Q} , or any extension such as for example $\tilde{\mathbb{Q}}$, can be found in [Sei54, Theorem 3, p. 370] or [BCR98, Theorem 1.4.2 and Corollary 1.4.7]. \square

The Tarski-Seidenberg theorem is related to the principle of *quantifier elimination*, see [BCR98, Proposition 5.2.2].

Throughout the theory, it does not matter whether we work with $\tilde{\mathbb{Q}}$ -coefficients or \mathbb{Q} -coefficients. The proof of the following result was suggested to us by C. Scheiderer.

Proposition 2.6.5. *Let $G \subset \mathbb{R}^n$ be a $\tilde{\mathbb{Q}}$ -semi-algebraic set. Then G is even \mathbb{Q} -semi-algebraic. More precisely, the defining inequalities in \mathbb{R}^n can be chosen with \mathbb{Q} -coefficients.*

Proof. Assume that G is defined by inequalities $h_i \leq 0$ for $h_i \in \tilde{\mathbb{Q}}[x_1, \dots, x_n]$ for $i = 1, \dots, m$. The coefficients are already contained in a field $K \subset \mathbb{R}$ which is finite over \mathbb{Q} . Let u be a primitive element of K with $f \in \mathbb{Q}[y]$ a minimal polynomial. Write the polynomials as $h_i(x_1, \dots, x_n) = H_i(x_1, \dots, x_n, u)$ with $H_i \in \mathbb{Q}[x_1, \dots, x_n, u]$. Choose rational numbers $a, b \in \mathbb{Q}$ such that u is the only root of f between a and b . Then G can be described by

$$G = \{(x_1, \dots, x_n) \in \mathbb{R}^n \mid \exists y \text{ with } f(y) = 0 \text{ and } a < y < b \text{ such that } H_i(x_1, \dots, x_n, y) \leq 0 \forall i = 1, \dots, m\}.$$

Hence G is the image of the \mathbb{Q} -semi-algebraic set

$$\tilde{G} = \{(x_1, \dots, x_n, y) \in \mathbb{R}^{n+1} \mid f(y) = 0 \text{ and } a < y < b \text{ and } H_i(x_1, \dots, x_n, y) \leq 0 \forall i = 1, \dots, m\}$$

under the projection to the first n coordinates. By the \mathbb{Q} -version of Fact 2.6.4 this implies that G is defined by polynomial equations with rational coefficients. \square

As the terminology suggests, algebraic varieties are semi-algebraic. Indeed, this is even true for the associated complex analytic space.

Lemma 2.6.6. *Let X be a quasi-projective algebraic variety defined over $\tilde{\mathbb{Q}}$ (or \mathbb{Q}). Then we can regard the complex analytic space X^{an} associated to the base change $X_{\mathbb{C}} = X \times_{\tilde{\mathbb{Q}}} \mathbb{C}$ (or $X_{\mathbb{C}} = X \times_{\mathbb{Q}} \mathbb{C}$) as a bounded $\tilde{\mathbb{Q}}$ -semi-algebraic subset (or \mathbb{Q} -semi-algebraic subset).*

$$X^{\text{an}} \subseteq \mathbb{R}^N \tag{2.3}$$

for some N . Moreover, if $f : X \rightarrow Y$ is a morphism of varieties defined over \mathbb{Q} , we can consider $f^{\text{an}} : X^{\text{an}} \rightarrow Y^{\text{an}}$ as a \mathbb{Q} -semi-algebraic map with respect to these embeddings.

Remark 2.6.7. We will mostly consider the case when X is affine. Then $X \subset \mathbb{C}^n$ is defined by polynomial equations with coefficients in \mathbb{Q} . We identify $\mathbb{C}^n \cong \mathbb{R}^{2n}$ and rewrite the equations for the real and imaginary part. Hence X is obviously \mathbb{Q} -semi-algebraic. In the lemma, we will show in addition that X can be embedded as a bounded \mathbb{Q} -semi-algebraic set.

Proof of Lemma 2.6.6. The case for \mathbb{Q} follows from the case $\tilde{\mathbb{Q}}$ as the two notions agree. Alternatively, the proof given below works without changes over other fields than $\tilde{\mathbb{Q}}$.

First step $X = \mathbb{P}_{\mathbb{Q}}^n$: Consider

- $\mathbb{P}_{\mathbb{C}}^n = (\mathbb{P}_{\tilde{\mathbb{Q}}}^n \times_{\tilde{\mathbb{Q}}} \mathbb{C})^{\text{an}}$ with homogeneous coordinates x_0, \dots, x_n , which we split as $x_m = a_m + ib_m$ with $a_m, b_m \in \mathbb{R}$ the real and imaginary parts, and
- \mathbb{R}^N , $N = 2(n+1)^2$, with coordinates $\{y_{kl}, z_{kl}\}_{k,l=0,\dots,n}$.

We define an explicit map

$$\begin{aligned} \psi : \mathbb{P}_{\mathbb{C}}^n &\longrightarrow \mathbb{R}^N \\ [x_0 : \dots : x_n] &\mapsto \left(\dots, \underbrace{\frac{\operatorname{Re} x_k \bar{x}_l}{\sum_{m=0}^n |x_m|^2}}_{y_{kl}}, \underbrace{\frac{\operatorname{Im} x_k \bar{x}_l}{\sum_{m=0}^n |x_m|^2}}_{z_{kl}}, \dots \right) \\ [a_0 + ib_0 : \dots : a_n + ib_n] &\mapsto \left(\dots, \underbrace{\frac{a_k a_l + b_k b_l}{\sum_{m=0}^n (a_m^2 + b_m^2)}}_{y_{kl}}, \underbrace{\frac{b_k a_l - a_k b_l}{\sum_{m=0}^n (a_m^2 + b_m^2)}}_{z_{kl}}, \dots \right). \end{aligned}$$

We can understand this map as a section of a natural fibre bundle on $\mathbb{P}_{\mathbb{C}}^n$. Its total space is given by the set E of hermitian $(n+1) \times (n+1)$ -matrices of rank 1. The map

$$\phi : E \rightarrow \mathbb{P}_{\mathbb{C}}^n$$

takes a linear map M to its image in \mathbb{C}^{n+1} . We get a section of ϕ by mapping a 1-dimensional subspace L of \mathbb{C}^{n+1} to the matrix of the orthogonal projection from \mathbb{C}^{n+1} to L with respect to the standard hermitian product on \mathbb{C}^{n+1} . We can describe this section in coordinates. Let $(x_0, \dots, x_n) \in \mathbb{C}^{n+1}$ be a vector of length 1. Then an elementary computation shows that $M = (x_i \bar{x}_j)_{i,j}$ is the hermitian projector to the line $L = \mathbb{C}(x_0, \dots, x_n)$. Writing the real and imaginary part of the matrix M separately gives us precisely the formula for ψ . In particular, ψ is injective.

Therefore, we can consider $\mathbb{P}_{\mathbb{C}}^n$ via ψ as a subset of \mathbb{R}^N . It is obvious from the explicit formula that it takes values in the unit sphere $S^{N-1} \subset \mathbb{R}^N$, hence

it is bounded. We claim that $\psi(\mathbb{P}_{\mathbb{C}}^n)$ is also $\tilde{\mathbb{Q}}$ -semi-algebraic. The composition of the projection

$$\begin{aligned} \pi : \mathbb{R}^{2(n+1)} \setminus \{(0, \dots, 0)\} &\longrightarrow \mathbb{P}_{\mathbb{C}}^n \\ (a_0, b_0, \dots, a_n, b_n) &\mapsto [a_0 + ib_0 : \dots : a_n + ib_n] \end{aligned}$$

with the map ψ is a polynomial map, hence it is $\tilde{\mathbb{Q}}$ -semi-algebraic by Example 2.6.3. Thus

$$\text{Im}(\psi \circ \pi) = \text{Im } \psi \subseteq \mathbb{R}^N$$

is $\tilde{\mathbb{Q}}$ -semi-algebraic by Fact 2.6.4.

Second step (zero set of a polynomial): We use the notation

$$\begin{aligned} V(g) &:= \{\underline{x} \in \mathbb{P}_{\mathbb{C}}^n \mid g(\underline{x}) = 0\} \quad \text{for } g \in \mathbb{C}[x_0, \dots, x_n] \text{ homogeneous, and} \\ W(h) &:= \{\underline{t} \in \mathbb{R}^N \mid h(\underline{t}) = 0\} \quad \text{for } h \in \mathbb{C}[y_{00}, \dots, z_{nn}]. \end{aligned}$$

Let $X^{\text{an}} = V(g)$ for some homogeneous $g \in \tilde{\mathbb{Q}}[x_0, \dots, x_n]$. Then $\psi(X^{\text{an}}) \subseteq \mathbb{R}^N$ is a $\tilde{\mathbb{Q}}$ -semi-algebraic subset, as a little calculation shows. Setting for $k = 0, \dots, n$

$$\begin{aligned} g_k &:= "g(\underline{x} \bar{x}_k)" \\ &= g(x_0 \bar{x}_k, \dots, x_n \bar{x}_k) \\ &= g((a_0 a_k + b_0 b_k) + i(b_0 a_k - a_0 b_k), \dots, (a_n a_k + b_n b_k) + i(b_n a_k - a_n b_k)), \end{aligned}$$

where $x_j = a_j + ib_j$ for $j = 0, \dots, n$, and

$$h_k := g(y_{0k} + iz_{0k}, \dots, y_{nk} + iz_{nk}),$$

we obtain

$$\begin{aligned} \psi(X^{\text{an}}) &= \psi(V(g)) \\ &= \bigcap_{k=0}^n \psi(V(g_k)) \\ &= \bigcap_{k=0}^n \psi(\mathbb{P}_{\mathbb{C}}^n) \cap W(h_k) \\ &= \bigcap_{k=0}^n \psi(\mathbb{P}_{\mathbb{C}}^n) \cap W(\text{Re } h_k) \cap W(\text{Im } h_k). \end{aligned}$$

Final step: We can choose an embedding

$$X \subseteq \mathbb{P}_{\mathbb{Q}}^n,$$

thus getting

$$X^{\text{an}} \subseteq \mathbb{P}_{\mathbb{C}}^n.$$

Since X is a locally closed subvariety of $\mathbb{P}_{\mathbb{Q}}^n$, the space X^{an} can be expressed in terms of subvarieties of the form $V(g)$ with $g \in \tilde{\mathbb{Q}}[x_0, \dots, x_n]$, using only the following basic operations

1. complementary set,
2. finite intersection,
3. finite union.

Now $\tilde{\mathbb{Q}}$ -semi-algebraic sets are stable under these operations as well, hence the first assertion is proved.

Second assertion: The first part of the lemma provides us with $\tilde{\mathbb{Q}}$ -semi-algebraic inclusions

$$\begin{aligned} \psi : X^{\text{an}} &\subseteq \mathbb{P}_{\mathbb{C}}^n \subseteq \mathbb{R}^N, \\ \phi : Y^{\text{an}} &\subseteq \mathbb{P}_{\mathbb{C}}^m \subseteq \mathbb{R}^M. \end{aligned}$$

We use the complex coordinates $\underline{x} = [x_0 : \dots : x_n]$ and $\underline{u} = [u_0 : \dots : u_m]$ on $\mathbb{P}_{\mathbb{C}}^n$ and $\mathbb{P}_{\mathbb{C}}^m$, respectively, and the real coordinates $(y_{00}, z_{00}, \dots, y_{nn}, z_{nn})$ and $(v_{00}, w_{00}, \dots, v_{mm}, w_{mm})$ on \mathbb{R}^N and \mathbb{R}^M , respectively. We use the notation

$$V(g) := \{(\underline{x}, \underline{u}) \in \mathbb{P}_{\mathbb{C}}^n \times \mathbb{P}_{\mathbb{C}}^m \mid g(\underline{x}, \underline{u}) = 0\}$$

for $g \in \mathbb{C}[x_0, \dots, x_n, u_0, \dots, u_m]$ homogeneous in both \underline{x} and \underline{u} , and

$$W(h) := \{\underline{t} \in \mathbb{R}^{N+M} \mid h(\underline{t}) = 0\}$$

for $h \in \mathbb{C}[y_{00}, \dots, z_{nn}, v_{00}, \dots, w_{mm}]$. Let $\{U_i\}$ be a finite open affine covering of X such that $f(U_i)$ satisfies

- $f(U_i)$ does not meet the hyperplane $\{u_j = 0\} \subset \mathbb{P}_{\mathbb{Q}}^m$ for some j , and
- $f(U_i)$ is contained in an open affine subset V_i of Y .

This is always possible, since we can start with the open covering $Y \cap \{u_j \neq 0\}$ of Y , take a subordinate open affine covering $\{V_{i'}\}$, and then choose a finite open affine covering $\{U_i\}$ subordinate to $\{f^{-1}(V_{i'})\}$. Now each of the maps

$$f_i := f^{\text{an}}|_{U_i} : U_i^{\text{an}} \longrightarrow Y^{\text{an}}$$

has image contained in V_i^{an} and does not meet the hyperplane $\{\underline{u} \in \mathbb{P}_{\mathbb{C}}^m \mid u_j = 0\}$ for an appropriate j . Being associated to an algebraic map between affine varieties, this map is rational

$$f_i : \underline{x} \mapsto \left[\frac{g'_0(\underline{x})}{g''_0(\underline{x})} : \dots : \frac{g'_{j-1}(\underline{x})}{g''_{j-1}(\underline{x})} : \frac{1}{g''_{j+1}(\underline{x})} : \frac{g'_{j+1}(\underline{x})}{g''_{j+1}(\underline{x})} : \dots : \frac{g'_m(\underline{x})}{g''_m(\underline{x})} \right],$$

with $g'_k, g''_k \in \tilde{\mathbb{Q}}[x_0, \dots, x_n]$, $k = 0, \dots, \hat{j}, \dots, m$. Since the graph $\Gamma_{f^{\text{an}}}$ of f^{an} is the finite union of the graphs Γ_{f_i} of the f_i , it is sufficient to prove that $(\psi \times \phi)(\Gamma_{f_i})$ is a $\tilde{\mathbb{Q}}$ -semi-algebraic subset of \mathbb{R}^{N+M} . Now

$$\begin{aligned} \Gamma_{f_i} &= (U_i^{\text{an}} \times V_i^{\text{an}}) \cap \bigcap_{\substack{k=0 \\ k \neq j}}^n V\left(\frac{y_k}{y_j} - \frac{g'_k(\underline{x})}{g''_k(\underline{x})}\right) \\ &= (U_i^{\text{an}} \times V_i^{\text{an}}) \cap \bigcap_{\substack{k=0 \\ k \neq j}}^n V(y_k g''_k(\underline{x}) - y_j g'_k(\underline{x})), \end{aligned}$$

so all we have to deal with is

$$V(y_k g''_k(\underline{x}) - y_j g'_k(\underline{x})).$$

Again a little calculation is necessary. Setting

$$\begin{aligned} g_{pq} &:= "u_k \bar{u}_q g''_k(\underline{x} \bar{x}_p) - u_j \bar{u}_q g'_k(\underline{x} \bar{x}_p)" \\ &= u_k \bar{u}_q g''_k(x_0 \bar{x}_p, \dots, x_n \bar{x}_p) - u_j \bar{u}_q g'_k(x_0 \bar{x}_p, \dots, x_n \bar{x}_p) \\ &= ((c_k c_q + d_k d_q) + i(d_k c_q - c_k d_q)) \\ &\quad g''_k((a_0 a_p + b_0 b_p) + i(b_0 a_p - a_0 b_p), \dots, (a_n a_p + b_n b_p) + i(b_n a_p - a_n b_p)) \\ &\quad - ((c_j c_q + d_j d_q) + i(d_j c_q - c_j d_q)) \\ &\quad g'_k((a_0 a_p + b_0 b_p) + i(b_0 a_p - a_0 b_p), \dots, (a_n a_p + b_n b_p) + i(b_n a_p - a_n b_p)), \end{aligned}$$

where $x_l = a_l + ib_l$ for $l = 0, \dots, n$, $u_l = c_l + id_l$ for $l = 0, \dots, m$, and

$$\begin{aligned} h_{pq} &:= (v_{kq} + iw_{kq}) g''_k(y_{0p} + iz_{0p}, \dots, y_{np} + iz_{np}) \\ &\quad - (v_{jq} + iw_{jq}) g'_k(y_{0p} + iz_{0p}, \dots, y_{np} + iz_{np}), \end{aligned}$$

we obtain

$$\begin{aligned} &(\psi \times \phi)\left(V(y_k g''_k(\underline{x}) - y_j g'_k(\underline{x}))\right) \\ &= \bigcap_{p=0}^n \bigcap_{q=0}^m (\psi \times \phi)(V(g_{pq})) \\ &= \bigcap_{p=0}^n \bigcap_{q=0}^m (\psi \times \phi)(U_i^{\text{an}} \times V_j^{\text{an}}) \cap W(h_{pq}) \\ &= \bigcap_{p=0}^n \bigcap_{q=0}^m (\psi \times \phi)(U_i^{\text{an}} \times V_j^{\text{an}}) \cap W(\text{Re } h_{pq}) \cap W(\text{Im } h_{pq}). \end{aligned}$$

□

2.6.2 Semi-algebraic singular chains

We need further prerequisites in order to state the promised Proposition 2.6.9.

Definition 2.6.8 ([Hir75, p. 168]). By an *open simplex* Δ° we mean the interior of a simplex (i.e., the convex hull of $r+1$ points in \mathbb{R}^n which span an r -dimensional subspace). For convenience, a point is considered as an open simplex as well.

The notation Δ_d will be reserved for the *closed standard simplex* spanned by the standard basis

$$\{e_i = (0, \dots, 0, \underset{i}{1}, 0, \dots, 0) \mid i = 1, \dots, d+1\}$$

of \mathbb{R}^{d+1} .

Consider the following data (*):

- X a variety defined over $\tilde{\mathbb{Q}}$,
- D a divisor in X with normal crossings, and
- $\gamma \in H_p^{\text{sing}}(X^{\text{an}}, D^{\text{an}}; \mathbb{Q})$, $p \in \mathbb{N}_0$.

As before, we have denoted by X^{an} and D^{an} the complex analytic space associated to the base change $X_{\mathbb{C}} = X \times_{\tilde{\mathbb{Q}}} \mathbb{C}$ and $D_{\mathbb{C}} = D \times_{\tilde{\mathbb{Q}}} \mathbb{C}$, respectively.

By Lemma 2.6.6, we may consider both X^{an} and D^{an} as bounded $\tilde{\mathbb{Q}}$ -semi-algebraic subsets of \mathbb{R}^N .

We are now able to formulate the main result of Section 2.6.

Proposition 2.6.9. *With data (*) as above, we can find a representative of γ that is a rational linear combination of $\tilde{\mathbb{Q}}$ -semi-algebraic singular simplices.*

The proof of this proposition relies on the following proposition due to Lojasiewicz, which has been written down by Hironaka.

Proposition 2.6.10 ([Hir75, p. 170]). *For $\{X_i\}$ a finite system of bounded $\tilde{\mathbb{Q}}$ -semi-algebraic sets in \mathbb{R}^n , there exists a simplicial decomposition*

$$\mathbb{R}^n = \coprod_j \Delta_j^\circ$$

by open simplices Δ_j° of dimensions $d(j)$ and a $\tilde{\mathbb{Q}}$ -semi-algebraic automorphism

$$\kappa : \mathbb{R}^n \rightarrow \mathbb{R}^n$$

such that each X_i is a finite union of some of the $\kappa(\Delta_j^\circ)$.

Note 2.6.11. Although Hironaka considers \mathbb{R} -semi-algebraic sets, we can safely replace \mathbb{R} by $\tilde{\mathbb{Q}}$ in this result (including the fact he cites from [Sei54]). The only problem that could possibly arise concerns a “good direction lemma”:

Lemma 2.6.12 (Good direction lemma for \mathbb{R} , [Hir75, p. 172], [KB32, Theorem 5.I, p. 242]).

Let Z be an \mathbb{R} -semi-algebraic subset of \mathbb{R}^n , which is nowhere dense. A direction $v \in \mathbb{P}_{\mathbb{R}}^{n-1}(\mathbb{R})$ is called good if any line l in \mathbb{R}^n parallel to v meets Z in a discrete (possibly empty) set of points; otherwise v is called bad. Then the set $B(Z)$ of bad directions is a Baire category set in $\mathbb{P}_{\mathbb{R}}^{n-1}(\mathbb{R})$.

This immediately gives good directions $v \in \mathbb{P}_{\mathbb{R}}^{n-1}(\mathbb{R}) \setminus B(Z)$, but not necessarily $v \in \mathbb{P}_{\tilde{\mathbb{Q}}}^{n-1}(\tilde{\mathbb{Q}}) \setminus B(Z)$. However, in Remark 2.1 of [Hir75], which follows directly after the lemma, the following statement is made: If Z is compact, then $B(Z)$ is closed in $\mathbb{P}_{\mathbb{R}}^{n-1}(\mathbb{R})$. In particular, $\mathbb{P}_{\tilde{\mathbb{Q}}}^{n-1}(\tilde{\mathbb{Q}}) \setminus B(Z)$ will be non-empty. Since we only consider bounded $\tilde{\mathbb{Q}}$ -semi-algebraic sets Z' , we may take $Z := \overline{Z'}$ (which is compact by Heine–Borel), and thus find a good direction $v \in \mathbb{P}_{\tilde{\mathbb{Q}}}^{n-1}(\tilde{\mathbb{Q}}) \setminus B(Z')$ using $B(Z') \subseteq B(Z)$. Hence:

Lemma 2.6.13 (Good direction lemma for $\tilde{\mathbb{Q}}$). Let Z' be a bounded $\tilde{\mathbb{Q}}$ -semi-algebraic subset of \mathbb{R}^n which is nowhere dense. Then the set $\mathbb{P}_{\tilde{\mathbb{Q}}}^{n-1}(\tilde{\mathbb{Q}}) \setminus B(Z')$ of good directions is non-empty.

Proof of Proposition 2.6.9. Applying Proposition 2.6.10 to the two-element system of $\tilde{\mathbb{Q}}$ -semi-algebraic sets $X^{\text{an}}, D^{\text{an}} \subseteq \mathbb{R}^N$, we obtain a $\tilde{\mathbb{Q}}$ -semi-algebraic decomposition

$$\mathbb{R}^N = \coprod_j \Delta_j^\circ$$

of \mathbb{R}^N by open simplices Δ_j° and a $\tilde{\mathbb{Q}}$ -semi-algebraic automorphism

$$\kappa : \mathbb{R}^N \rightarrow \mathbb{R}^N.$$

We write Δ_j for the closure of Δ_j° . The sets

$$K := \{\Delta_j^\circ \mid \kappa(\Delta_j^\circ) \subseteq X^{\text{an}}\} \quad \text{and} \quad L := \{\Delta_j^\circ \mid \kappa(\Delta_j^\circ) \subseteq D^{\text{an}}\}$$

can be thought of as finite simplicial complexes, but built out of open instead of closed simplices. We define their *geometric realisations*

$$|K| := \bigcup_{\Delta_j^\circ \in K} \Delta_j^\circ \quad \text{and} \quad |L| := \bigcup_{\Delta_j^\circ \in L} \Delta_j^\circ.$$

Then Proposition 2.6.10 states that κ maps the pair of topological spaces $(|K|, |L|)$ homeomorphically to $(X^{\text{an}}, D^{\text{an}})$.

Easy case: If X is complete, so is $X_{\mathbb{C}}$ by [Har77, Corollary II.4.8(c), p. 102], hence X^{an} and D^{an} will be compact by [Har77, Appendix B.1, p. 439]. In this situation,

$$\overline{K} := \{\Delta_j \mid \kappa(\Delta_j) \subseteq X^{\text{an}}\} \quad \text{and} \quad \overline{L} := \{\Delta_j \mid \kappa(\Delta_j) \subseteq D^{\text{an}}\}$$

are (ordinary) simplicial complexes (see Definition 2.3.3), whose geometric realisations coincide with those of K and L , respectively. In particular,

$$\begin{aligned} H_*^{\text{simpl}}(\overline{K}, \overline{L}; \mathbb{Q}) &\cong H_*^{\text{sing}}(|\overline{K}|, |\overline{L}|; \mathbb{Q}) \\ &\cong H_*^{\text{sing}}(|K|, |L|; \mathbb{Q}) \\ &\cong H_*^{\text{sing}}(X^{\text{an}}, D^{\text{an}}; \mathbb{Q}). \end{aligned} \quad (2.4)$$

Here $H_*^{\text{simpl}}(\overline{K}, \overline{L}; \mathbb{Q})$ denotes simplicial homology, of course.

We write $\gamma_{\text{simpl}} \in H_p^{\text{simpl}}(\overline{K}, \overline{L}; \mathbb{Q})$ and $\gamma_{\text{sing}} \in H_p^{\text{sing}}(|\overline{K}|, |\overline{L}|; \mathbb{Q})$ for the image of γ under this isomorphism. Any representative Γ_{simpl} of γ_{simpl} is a rational linear combination

$$\Gamma_{\text{simpl}} = \sum_j a_j \Delta_j, \quad a_j \in \mathbb{Q}$$

of closed simplices $\Delta_j \in \overline{K}$. We orient them according the global orientation of X^{an} . We can choose orientation-preserving affine-linear maps of the standard simplex Δ_p to Δ_j

$$\sigma_j : \Delta_p \longrightarrow \Delta_j \quad \text{for } \Delta_j \in \Gamma_{\text{simpl}}.$$

These maps yield a representative

$$\Gamma_{\text{sing}} := \sum_j a_j \sigma_j$$

of γ_{sing} . Composing with κ yields $\Gamma := \kappa_* \Gamma_{\text{sing}} \in \gamma$, where Γ has the desired properties.

In the *general case*, we perform a barycentric subdivision \mathcal{B} on K twice (once is not enough) and define $|K|$ and $|L|$ not as the ‘‘closure’’ of K and L , but as follows (see Figure 2.1)

$$\begin{aligned} \overline{K} &:= \{\Delta \mid \Delta^\circ \in \mathcal{B}^2(K) \text{ and } \Delta \subseteq |K|\}, \\ \overline{L} &:= \{\Delta \mid \Delta^\circ \in \mathcal{B}^2(K) \text{ and } \Delta \subseteq |L|\}. \end{aligned} \quad (2.5)$$

The point is that the pair of topological spaces $(|\overline{K}|, |\overline{L}|)$ is a strong deformation retract of $(|K|, |L|)$. Assuming this, we see that in the general case with $\overline{K}, \overline{L}$ defined as in (2.5), the isomorphism (2.4) still holds and we can proceed as in the easy case to prove the proposition.

We define the retraction map

$$\rho : (|K| \times [0, 1], |L| \times [0, 1]) \rightarrow (|\overline{K}|, |\overline{L}|)$$

as follows: Let $\Delta_j^\circ \in K$ be an open simplex which is not contained in the boundary of any other simplex of K and set

$$\text{inner} := \Delta_j \cap \overline{K}, \quad \text{outer} := \Delta_j \setminus \overline{K}.$$

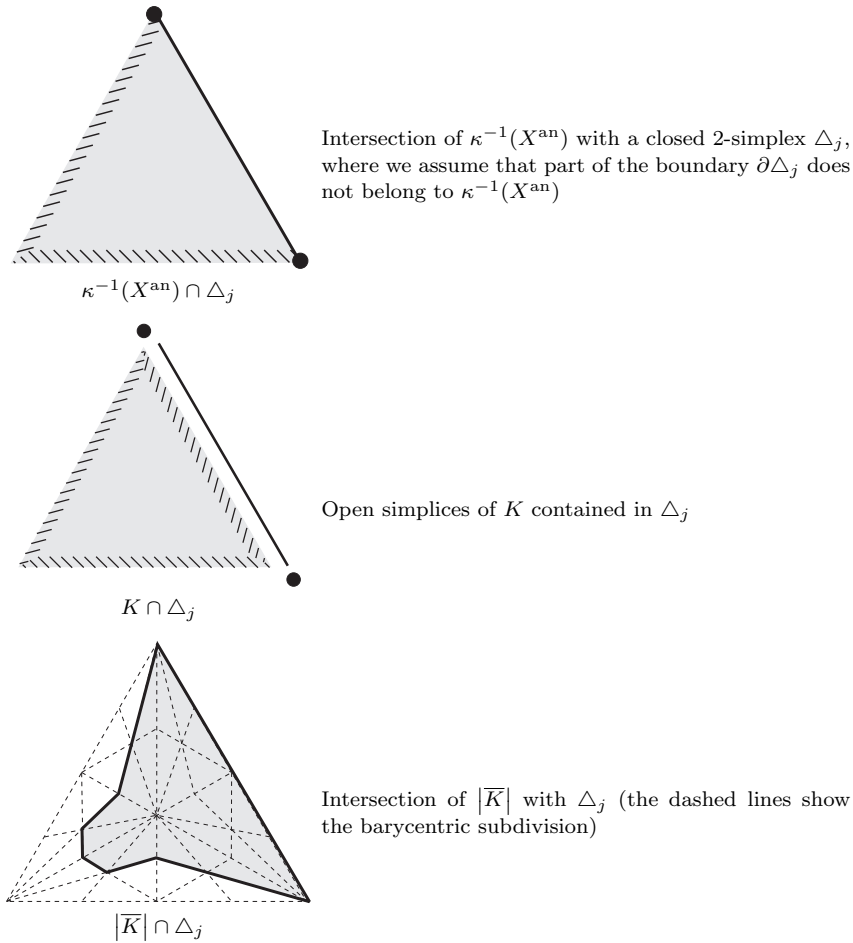

Fig. 2.1 Definition of \overline{K}

Note that *inner* is closed. For any point $p \in \text{outer}$ the ray \vec{cp} from the center c of Δ_j° through p “leaves” the set *inner* at a point q_p , i.e., $\vec{cp} \cap \text{inner}$ equals the line segment cq_p ; see Figure 2.2. The map

$$\rho_j : \Delta_j \times [0, 1] \rightarrow \Delta_j$$

$$(p, t) \mapsto \begin{cases} p & \text{if } p \in \text{inner}, \\ q_p + t \cdot (p - q_p) & \text{if } p \in \text{outer} \end{cases}$$

retracts Δ_j onto *inner*.

Now these maps ρ_j glue together to give the desired homotopy ρ . □

We want to state one of the intermediate results of this proof explicitly:

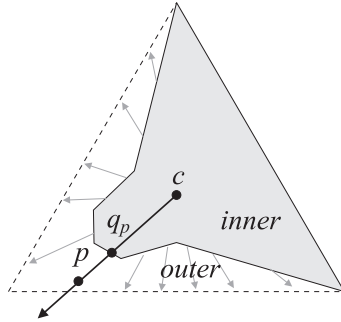

Fig. 2.2 Definition of q_p

Corollary 2.6.14. *Let X and D be as above. Then the pair of topological spaces $(X^{\text{an}}, D^{\text{an}})$ is homotopy equivalent to a pair of (realisations of) simplicial complexes $(|X^{\text{simp}}|, |D^{\text{simp}}|)$.*

2.7 Singular cohomology via the h' -topology

In order to give a simple description of the period isomorphism for singular varieties, we are going to need a more sophisticated description of singular cohomology.

We work in the category An of complex analytic spaces with morphisms given by holomorphic maps.

Definition 2.7.1. Let X be a complex analytic space. The h' -topology on the category $(\text{An}/X)_{h'}$ of complex analytic spaces over X is the smallest Grothendieck topology such that the following are covering maps:

1. proper surjective morphisms;
2. open covers.

If \mathcal{F} is a presheaf of An/X we denote by $\mathcal{F}_{h'}$ its sheafification in the h' -topology.

Remark 2.7.2. This definition is inspired by Voevodsky's h -topology on the category of schemes, see Section 3.2. We are not sure if it is the correct analogue in the analytic setting. However, it is good enough for our purposes.

Lemma 2.7.3. *For $Y \in \text{An}$ let \mathbb{C}_Y be the (ordinary) sheaf associated to the constant presheaf \mathbb{C} . Then*

$$Y \mapsto \mathbb{C}_Y(Y)$$

is an h' -sheaf on An .

Proof. We have to check the sheaf condition for the generators of the topology. By assumption, it is satisfied for open covers. Let $\tilde{Y} \rightarrow Y$ be a proper

surjective morphism. Without loss of generality, we can assume that Y is connected. Let $Y = \bigcup_{j \in J} Y_j$ be the decomposition into irreducible components. Let \tilde{Y}_i for $i \in I$ be the collection of connected components of \tilde{Y} . The index set is at most countable. For each i the image of \tilde{Y}_i in Y is closed. An irreducible analytic space cannot be covered by countably many proper closed subspaces, hence for every irreducible component Y_j of Y we can choose an index $i(j)$ such that Y_j is contained in the image of $\tilde{Y}_{i(j)}$. Then

$$\tilde{Y} \times_Y \tilde{Y} = \bigcup_{i, i' \in I} \tilde{Y}_i \times_Y \tilde{Y}_{i'}.$$

We have to compute the kernel of

$$\prod_{i \in I} \mathbb{C}(\tilde{Y}_i) \rightarrow \prod_{i, i'} \mathbb{C}(\tilde{Y}_i \times_Y \tilde{Y}_{i'})$$

via the difference of the two natural restriction maps. We have $\mathbb{C}(\tilde{Y}_i) = \mathbb{C}$. Let $a = (a_i)_{i \in I}$ be in the kernel. Comparing the complex numbers a_i and $a_{i'}$ in $\mathbb{C}(\tilde{Y}_i \times_Y \tilde{Y}_{i'})$ we see that they agree unless $\tilde{Y}_i \times_Y \tilde{Y}_{i'}$ is empty. If the image of \tilde{Y}_i meets the irreducible component Y_i , then $a_i = a_{i(j)}$ for the distinguished index chosen above. In particular, $a_{i(j)} = a_{i(j')}$ if $Y_j \cap Y_{j'} \neq \emptyset$. As Y is connected, this implies that all a_i are the same. Hence the kernel is just the one copy of $\mathbb{C} = \mathbb{C}(Y)$. \square

Proposition 2.7.4. *Let X be an analytic space and $i : Z \subset X$ a closed subspace. Then there is a morphism of sites $\rho : (\text{An}/X)_{h'} \rightarrow X$. It induces an isomorphism*

$$H_{\text{sing}}^i(X, Z; \mathbb{C}) \rightarrow H_{h'}^i((\text{An}/X)_{h'}, \text{Ker}(\mathbb{C}_{h'} \rightarrow i_* \mathbb{C}_{h'}))$$

compatible with long exact sequences and products.

Remark 2.7.5. This statement and the following proof can be extended to more general sheaves \mathcal{F} on An .

The argument uses the notion of a hypercover, see Definition 1.5.8.

Proof. We first treat the absolute case with $Z = \emptyset$. We use the theory of cohomological descent as developed in [SD72]. Singular cohomology satisfies cohomological descent for open covers. Proper base change, see Theorem 2.7.6, implies cohomological descent for proper surjective maps. Hence it satisfies cohomological descent for h' -covers. This implies that singular cohomology can be computed as a direct limit

$$\lim_{\mathfrak{X}_\bullet} \mathbb{C}(\mathfrak{X}_\bullet),$$

where \mathfrak{X}_\bullet runs through all h' -hypercovers. On the other hand, the same limit computes h' -cohomology, see Proposition 1.6.9. For the general case, recall that we have a short exact sequence

$$0 \rightarrow j_! \mathbb{C} \rightarrow \mathbb{C} \rightarrow i_* \mathbb{C} \rightarrow 0$$

of sheaves on X . Its pull-back to An/X maps naturally to the short exact sequence

$$0 \rightarrow \text{Ker}(\mathbb{C}_{h'} \rightarrow i_* \mathbb{C}_{h'}) \rightarrow \mathbb{C}_{h'} \rightarrow i_* \mathbb{C}_{h'} \rightarrow 0.$$

This reduces the comparison in the relative case to the absolute case once we have shown that $Ri_* \mathbb{C}_{h'} = i_* \mathbb{C}_{h'}$. The sheaf $R^n i_* \mathbb{C}_{h'}$ is given by the h' -sheafification of the presheaf

$$X' \mapsto H_{h'}^n(Z \times_X X', \mathbb{C}_{h'}) = H_{\text{sing}}^n(Z \times_X X', \mathbb{C})$$

for $X' \rightarrow X$ in An/X . By resolution of singularities for analytic spaces we may assume that X' is smooth and $Z' = X' \times_X Z$ is a divisor with normal crossings. By passing to an open cover, we may assume that Z' is an open ball in a union of coordinate hyperplanes, in particular contractible. Hence, its singular cohomology is trivial. This implies that $R^n i_* \mathbb{C}_{h'} = 0$ for $n \geq 1$. \square

Theorem 2.7.6 (Descent for proper hypercoverings). *Let $D \subset X$ be a closed subvariety and $D_\bullet \rightarrow D$ a proper hypercovering (see Definition 1.5.8), such that there is a commutative diagram*

$$\begin{array}{ccc} D_\bullet & \longrightarrow & X_\bullet \\ \downarrow & & \downarrow \\ D & \longrightarrow & X. \end{array}$$

Then one has cohomological descent for singular cohomology:

$$H^*(X, D; \mathbb{Z}) = H^*(\text{Cone}(\text{Tot}(X_\bullet) \rightarrow \text{Tot}(D_\bullet))[-1]; \mathbb{Z}).$$

Here, $\text{Tot}(-)$ denotes the total complex in $\mathbb{Z}[\text{Var}]$ associated to the corresponding simplicial variety, see Definition 1.5.11.

Proof. The relative case follows from the absolute case. The essential ingredient is proper base change, which allows us to reduce to the case where X is a point. The statement then becomes a completely combinatorial assertion on contractibility of simplicial sets. The results are summed up in [Del74b] (5.3.5). For a complete reference, see [SD72], in particular Corollaire 4.1.6. \square

Chapter 3

Algebraic de Rham cohomology

Let k be a field of characteristic zero. We are going to define relative algebraic de Rham cohomology for general varieties over k , not necessarily smooth.

3.1 The smooth case

In this section, all varieties are smooth over k . In this case, de Rham cohomology is defined as hypercohomology of the complex of sheaves of differentials.

3.1.1 Definition

Definition 3.1.1. Let X be a smooth variety over k . Let Ω_X^1 be the sheaf of k -linear algebraic differentials on X . For $p \geq 0$ let

$$\Omega_X^p = \bigwedge^p \Omega_X^1$$

be the exterior power in the category of \mathcal{O}_X -modules. The universal k -derivation $d : \mathcal{O}_X \rightarrow \Omega_X^1$ induces

$$d^p : \Omega_X^p \rightarrow \Omega_X^{p+1}.$$

We call (Ω_X^\bullet, d) the *algebraic de Rham complex* of X .

In more detail: if X is smooth of dimension n , the sheaf Ω_X^1 is locally free of rank n . This allows us to define exterior powers. Note that Ω_X^i vanishes for $i > n$. The differential is uniquely characterised by the properties:

1. $d^0 = d$ on \mathcal{O}_X ;
2. $d^{p+1}d^p = 0$ for all $p \geq 0$;

3. $d(\omega \wedge \omega') = d\omega \wedge \omega' + (-1)^p \omega \wedge d\omega'$ for all local sections ω of Ω_X^p and ω' of $\Omega_X^{p'}$.

Indeed, if t_1, \dots, t_n is a system of local parameters at $x \in X$, then local sections of Ω_X^p near x can be expressed as

$$\omega = \sum_{1 \leq i_1 < \dots < i_p \leq n} f_{i_1 \dots i_p} dt_{i_1} \wedge \dots \wedge dt_{i_p},$$

and we have

$$d^p \omega = \sum_{1 \leq i_1 < \dots < i_p \leq n} df_{i_1 \dots i_p} \wedge dt_{i_1} \wedge \dots \wedge dt_{i_p}.$$

Definition 3.1.2. Let X be a smooth variety over a field k of characteristic 0. We define *algebraic de Rham cohomology* of X as the hypercohomology

$$H_{\text{dR}}^i(X) = H^i(X, \Omega_X^\bullet).$$

For background material on hypercohomology, see Section 1.4. If X is smooth and affine, this simplifies to

$$H_{\text{dR}}^i(X) = H^i(\Omega_X^\bullet(X)).$$

Example 3.1.3. 1. Consider the affine line $X = \mathbb{A}_k^1 = \text{Spec}(k[t])$. Then

$$\Omega_{\mathbb{A}^1}^\bullet(\mathbb{A}^1) = \left[k[t] \xrightarrow{d} k[t]dt \right].$$

We have

$$\text{Ker}(d) = \{P \in k[t] \mid P' = 0\} = k, \quad \text{Im}(d) = k[t]dt,$$

because we have assumed characteristic zero. Hence

$$H_{\text{dR}}^i(\mathbb{A}^1) = \begin{cases} k & i = 0, \\ 0 & i > 0. \end{cases}$$

2. Consider the multiplicative group $X = \mathbb{G}_m = \text{Spec}(k[t, t^{-1}])$. Then

$$\Omega_{\mathbb{G}_m}^\bullet(\mathbb{G}_m) = \left[k[t, t^{-1}] \xrightarrow{d} k[t, t^{-1}]dt \right].$$

We have

$$\begin{aligned} \text{Ker}(d) &= \{P \in k[t] \mid P' = 0\} = k, \\ \text{Im}(d) &= \left\{ \sum_{i=n}^N a_i t^i dt \mid a_{-1} = 0 \right\}, \end{aligned}$$

again because of characteristic zero. Hence

$$H_{\text{dR}}^i(\mathbb{G}_m) = \begin{cases} k & i = 0, 1, \\ 0 & i > 1. \end{cases}$$

A generator for $H_{\text{dR}}^1(\mathbb{G}_m)$ is given by dt/t and the isomorphism to k is induced by the residue for meromorphic differential forms.

3. Let X be a connected smooth projective curve of genus g . We use the trivial filtration on the de Rham complex

$$0 \rightarrow \Omega_X^1[-1] \rightarrow \Omega_X^\bullet \rightarrow \mathcal{O}_X[0] \rightarrow 0.$$

The sheaves Ω_X^p are locally free and hence, in particular, coherent. The cohomological dimension of any variety X is the index i above which the cohomology $H^i(X, \mathcal{F})$ of any coherent sheaf \mathcal{F} vanishes, see [Har77, Chapter III, Section 4]. The cohomological dimension of a smooth, projective curve is 1, hence the long exact sequence reads

$$\begin{aligned} 0 = H^{-1}(X, \Omega_X^1) &\rightarrow H_{\text{dR}}^0(X) \rightarrow H^0(X, \mathcal{O}_X) \\ &\xrightarrow{\partial} H^0(X, \Omega_X^1) \rightarrow H_{\text{dR}}^1(X) \rightarrow H^1(X, \mathcal{O}_X) \\ &\xrightarrow{\partial} H^1(X, \Omega_X^1) \rightarrow H_{\text{dR}}^2(X) \rightarrow 0 \end{aligned}$$

This is a special case of the Hodge spectral sequence. It is known to degenerate (e.g. [Del71]). Hence the boundary maps ∂ vanish. By Serre duality, this yields

$$H_{\text{dR}}^i(X) \cong \begin{cases} H^0(X, \mathcal{O}_X) = k & i = 0, \\ H^1(X, \Omega_X^1) \cong H^0(X, \mathcal{O}_X)^\vee = k & i = 2, \\ 0 & i > 2. \end{cases}$$

The most interesting group for $i = 1$ sits in an exact sequence

$$0 \rightarrow H^0(X, \Omega_X^1) \rightarrow H_{\text{dR}}^1(X) \rightarrow H^0(X, \Omega_X^1)^\vee \rightarrow 0,$$

and hence

$$\dim H_{\text{dR}}^1(X) = 2g.$$

Remark 3.1.4. In these cases, the explicit computation shows that algebraic de Rham cohomology computes the standard Betti numbers of these varieties.

We are going to show in Chapter 5 that this is always true. In particular, it is always finite-dimensional. A second algebraic proof of this fact will also be given in Corollary 3.1.17.

Lemma 3.1.5. *Let X be a smooth variety of dimension d . Then $H_{\text{dR}}^i(X)$ vanishes for $i > 2d$. If, in addition, X is affine, it vanishes for $i > d$.*

Proof. We use the trivial filtration on the de Rham complex. This induces a system of long exact sequences relating the groups $H^i(X, \Omega_X^p)$ to algebraic de Rham cohomology.

Any variety of dimension d has cohomological dimension $\leq d$ for coherent sheaves [Har77, *ibid.*]. All Ω_X^p are coherent, hence $H^i(X, \Omega_X^p)$ vanishes for $i > d$. The complex Ω_X^\bullet is concentrated in degrees at most d . This adds up to cohomological dimension $2d$ for algebraic de Rham cohomology.

Affine varieties have cohomological dimension 0, hence $H^i(X, \Omega_X^p)$ vanishes already for $i > 0$. Again the complex Ω_X^\bullet is concentrated in degrees at most d , hence algebraic de Rham cohomology vanishes for $i > d$ in the affine case. \square

3.1.2 Functoriality

Let $f : X \rightarrow Y$ be a morphism of smooth varieties over k . We want to explain the functoriality

$$f^* : H_{\text{dR}}^i(Y) \rightarrow H_{\text{dR}}^i(X).$$

We use the Godement resolution (see Definition 1.4.8) and put

$$R\Gamma_{\text{dR}}(X) = \Gamma(X, Gd(\Omega_X^\bullet)).$$

The natural map $f^{-1}\mathcal{O}_Y \rightarrow \mathcal{O}_X$ induces a unique multiplicative map

$$f^{-1}\Omega_Y^\bullet \rightarrow \Omega_X^\bullet.$$

By functoriality of the Godement resolution, we have

$$f^{-1}Gd_Y(\Omega_Y^\bullet) \rightarrow Gd_X(f^{-1}\Omega_X^\bullet) \rightarrow Gd_X(\Omega_X^\bullet).$$

Taking global sections, this yields

$$R\Gamma_{\text{dR}}(Y) \rightarrow R\Gamma_{\text{dR}}(X).$$

It is easy to see that the assignment is compatible under composition. Hence:

Lemma 3.1.6. *De Rham cohomology $H_{\text{dR}}^i(\cdot)$ is a contravariant functor on the category of smooth varieties over k with values in k -vector spaces. It is induced by a functor*

$$R\Gamma_{\mathrm{dR}} : \mathrm{Sm} \rightarrow C^+(k\text{-Mod}).$$

Note that $\mathbb{Q} \subset k$, so the functor can be extended \mathbb{Q} -linearly to $\mathbb{Q}[\mathrm{Sm}]$. This allows us to extend the definition of algebraic de Rham cohomology to complexes of smooth varieties in the next step. Explicitly: let X^\bullet be an object of $C^-(\mathbb{Q}[\mathrm{Sm}])$. Then there is a double complex $K^{\bullet,\bullet}$ with

$$K^{n,m} = \Gamma(X^{-n}, Gd^m(\Omega^\bullet)).$$

Definition 3.1.7. Let X^\bullet be an object of $C^-(\mathbb{Q}[\mathrm{Sm}])$. We denote the total complex by

$$R\Gamma_{\mathrm{dR}}(X^\bullet) = \mathrm{Tot}(K^{\bullet,\bullet})$$

and set

$$H_{\mathrm{dR}}^i(X^\bullet) = H^i(R\Gamma_{\mathrm{dR}}(X^\bullet)).$$

We call this the *algebraic de Rham cohomology* of X^\bullet .

3.1.3 Cup product

Let X be a smooth variety over k . The wedge product of differential forms turns Ω_X^\bullet into a differential graded algebra:

$$\mathrm{Tot}(\Omega_X^\bullet \otimes_k \Omega_X^\bullet) \rightarrow \Omega_X^\bullet.$$

See Definition 3.1.1 for the compatibility of wedge products and differentials.

Lemma 3.1.8 (Cup product). $H_{\mathrm{dR}}^*(X)$ carries a natural multiplication

$$\cup : H_{\mathrm{dR}}^i(X) \otimes_k H_{\mathrm{dR}}^j(X) \rightarrow H_{\mathrm{dR}}^{i+j}(X)$$

induced by the wedge product of differential forms.

Proof. We need to define

$$R\Gamma_{\mathrm{dR}}(X) \otimes_k R\Gamma_{\mathrm{dR}}(X) \rightarrow R\Gamma_{\mathrm{dR}}(X)$$

as a morphism in the derived category. We have quasi-isomorphisms

$$\Omega_X^\bullet \otimes \Omega_X^\bullet \rightarrow Gd(\Omega_X^\bullet) \otimes Gd(\Omega_X^\bullet),$$

and hence a quasi-isomorphism of flasque resolutions of $\Omega_X^\bullet \otimes \Omega_X^\bullet$

$$s : Gd(\Omega_X^\bullet \otimes \Omega_X^\bullet) \rightarrow Gd(Gd(\Omega_X^\bullet) \otimes Gd(\Omega_X^\bullet)).$$

In the derived category, this allows the composition

$$\begin{aligned}
R\Gamma_{\mathrm{dR}}(X) \otimes_k R\Gamma_{\mathrm{dR}}(X) &= \Gamma(X, Gd(\Omega_X^\bullet)) \otimes_k \Gamma(X, Gd(\Omega_X^\bullet)) \\
&\rightarrow \Gamma(X, Gd(\Omega^\bullet) \otimes Gd(\Omega_X^\bullet)) \\
&\rightarrow \Gamma(X, Gd(Gd(\Omega_X^\bullet) \otimes Gd(\Omega_X^\bullet))) \\
&\xleftarrow{s} \Gamma(X, Gd(\Omega_X^\bullet \otimes \Omega_X^\bullet)) \\
&\rightarrow \Gamma(X, Gd(\Omega_X^\bullet)) = R\Gamma_{\mathrm{dR}}(X).
\end{aligned}$$

□

The same method also allows the construction of an exterior product.

Proposition 3.1.9 (Künneth formula). *Let X, Y be smooth varieties. There is a natural multiplication induced by the wedge product of differential forms*

$$H_{\mathrm{dR}}^i(X) \otimes_k H_{\mathrm{dR}}^j(Y) \rightarrow H_{\mathrm{dR}}^{i+j}(X \times Y).$$

It induces an isomorphism

$$H_{\mathrm{dR}}^n(X \times Y) \cong \bigoplus_{i+j=n} H_{\mathrm{dR}}^i(X) \otimes_k H_{\mathrm{dR}}^j(Y).$$

Proof. Let $p : X \times Y \rightarrow X$ and $q : X \times Y \rightarrow Y$ be the projection maps. The exterior multiplication is given by

$$H_{\mathrm{dR}}^i(X) \otimes H_{\mathrm{dR}}^j(Y) \xrightarrow{p^* \otimes q^*} H_{\mathrm{dR}}^i(X \times Y) \otimes H_{\mathrm{dR}}^j(X \times Y) \xrightarrow{\cup} H_{\mathrm{dR}}^{i+j}(X \times Y).$$

The Künneth formula is most easily proved by comparison with singular cohomology. We postpone the proof to Lemma 5.3.3 in Chapter 5. □

Corollary 3.1.10 (Homotopy invariance). *Let X be a smooth variety. Then the natural map*

$$H_{\mathrm{dR}}^n(X) \rightarrow H_{\mathrm{dR}}^n(X \times \mathbb{A}^1)$$

is an isomorphism.

Proof. We combine the Künneth formula with the computation in the case of \mathbb{A}^1 in Example 3.1.3. □

3.1.4 Change of base field

Let K/k be an extension of fields of characteristic zero. We have the corresponding base change functor

$$X \mapsto X_K$$

from (smooth) varieties over k to (smooth) varieties over K . Let

$$\pi : X_K \rightarrow X$$

be the natural map of schemes. By standard calculus of differential forms,

$$\Omega_{X_K/K}^\bullet \cong \pi^* \Omega_{X/k}^\bullet = \pi^{-1} \Omega_{X/k}^\bullet \otimes_k K.$$

Lemma 3.1.11. *Let K/k be an extension of fields of characteristic zero. Let X be a smooth variety over k . Then there are natural isomorphisms*

$$H_{\text{dR}}^i(X) \otimes_k K \rightarrow H_{\text{dR}}^i(X_K).$$

They are induced by a natural quasi-isomorphism

$$R\Gamma_{\text{dR}}(X) \otimes_k K \rightarrow R\Gamma_{\text{dR}}(X_K).$$

Proof. By functoriality of the Godement resolution (see Lemma 1.4.10) and k -linearity, we get natural quasi-isomorphisms

$$\pi^{-1} Gd_X(\Omega_{X/k}^\bullet) \otimes_k K \rightarrow Gd_{X_K}(\pi^{-1} \Omega_{X/k}^\bullet) \rightarrow Gd_{X_K}(\Omega_{X_K/K}^\bullet).$$

As K is flat over k , taking global sections induces a sequence of quasi-isomorphisms

$$\begin{aligned} R\Gamma_{\text{dR}}(X) \otimes_k K &= \Gamma(X, Gd_X(\Omega_{X/k}^\bullet)) \otimes_k K \\ &\cong \Gamma(X_K, \pi^{-1} Gd_X(\Omega_{X/k}^\bullet)) \otimes_k K \\ &\cong \Gamma(X_K, \pi^{-1} Gd_X(\Omega_{X/k}^\bullet) \otimes_k K) \\ &\rightarrow \Gamma(X_K, Gd_{X_K}(\Omega_{X_K/K}^\bullet)) \\ &= R\Gamma_{\text{dR}}(X_K). \end{aligned}$$

□

Remark 3.1.12. This immediately extends to algebraic de Rham cohomology of complexes of smooth varieties.

Conversely, we can also restrict scalars.

Lemma 3.1.13. *Let K/k be a finite field extension. Let Y be a smooth variety over K . Then there is a natural isomorphism*

$$H_{\text{dR}}^i(Y/k) \rightarrow H_{\text{dR}}^i(Y/K).$$

It is induced by a natural isomorphism of complexes of k -vector spaces

$$R\Gamma_{\text{dR}}(Y/k) \rightarrow R\Gamma_{\text{dR}}(Y/K).$$

Proof. We use the sequence of sheaves on Y (see [Har77, Proposition 8.11])

$$\pi^* \Omega_{K/k}^1 \rightarrow \Omega_{Y/k}^1 \rightarrow \Omega_{Y/K}^1 \rightarrow 0,$$

where $\pi : Y \rightarrow \text{Spec}(K)$ is the structural map. As we are in characteristic 0, we have $\Omega_{K/k}^1 = 0$. This implies that we actually have identical de Rham complexes

$$\Omega_{Y/K}^\bullet = \Omega_{Y/k}^\bullet$$

and identical Godement resolutions. \square

3.1.5 Étale topology

In this section, we give an alternative interpretation of algebraic de Rham cohomology using the étale topology. The results are not used in our discussions of periods.

Let X_{et} be the small étale site on X , see Section 1.6. The complex of differential forms Ω_X^\bullet can be viewed as a complex of sheaves on X_{et} , see [Mil80, Chapter II, Example 1.2 and Proposition 1.3]. We write $\Omega_{X_{\text{et}}}^\bullet$ for distinction.

Lemma 3.1.14. *There is a natural isomorphism*

$$H_{\text{dR}}^i(X) \rightarrow H^i(X_{\text{et}}, \Omega_{X_{\text{et}}}^\bullet).$$

Proof. The map of sites $s : X_{\text{et}} \rightarrow X$ induces a map on cohomology

$$H^i(X, \Omega_X^\bullet) \rightarrow H^i(X_{\text{et}}, \Omega_{X_{\text{et}}}^\bullet).$$

We filter Ω_X^\bullet by the trivial filtration $F^p \Omega_X^\bullet$

$$0 \rightarrow F^{p+1} \Omega_X^\bullet \rightarrow F^p \Omega_X^\bullet \rightarrow \Omega_X^p[-p] \rightarrow 0$$

and compare the induced long exact sequences in cohomology on X and X_{et} . As the Ω_X^p are coherent, the comparison maps

$$H^i(X, \Omega_X^p) \rightarrow H^i(X_{\text{et}}, \Omega_{X_{\text{et}}}^p)$$

are isomorphisms by [Mil80, Chapter III, Proposition 3.7]. By descending induction on p , this implies that we have isomorphisms for all $F^p \Omega_X^\bullet$, in particular for Ω_X^\bullet itself. \square

3.1.6 Differentials with log poles

We give an alternative description of algebraic de Rham cohomology using differentials with log poles as introduced by Deligne, see [Del71, Chapter 3]. We are not going to use this point of view in our study of periods.

Let X be a smooth variety and $j : X \rightarrow \bar{X}$ an open immersion into a smooth projective variety such that $D = \bar{X} \setminus X$ is a divisor with simple normal crossings (see Definition 1.1.3).

Definition 3.1.15. Let

$$\Omega_{\bar{X}}^1 \langle D \rangle \subset j_* \Omega_X^1$$

be the locally free $\mathcal{O}_{\bar{X}}$ -module with the following basis: if $U \subset X$ is an affine open subvariety étale over \mathbb{A}^n via coordinates t_1, \dots, t_n and $D|_U$ is given by the equation $t_1 \dots t_r = 0$, then $\Omega_{\bar{X}}^1 \langle D \rangle|_U$ has $\mathcal{O}_{\bar{X}}$ -basis

$$\frac{dt_1}{t_1}, \dots, \frac{dt_r}{t_r}, dt_{r+1}, \dots, dt_n.$$

For $p > 1$ let

$$\Omega_{\bar{X}}^p \langle D \rangle = \bigwedge^p \Omega_{\bar{X}}^1 \langle D \rangle.$$

We call the $\Omega_{\bar{X}}^\bullet \langle D \rangle$ the *complex of differentials with log poles along D* .

Note that the differential of $j_* \Omega_X^\bullet$ respects $\Omega_{\bar{X}}^\bullet \langle D \rangle$, so that this is indeed a subcomplex.

Proposition 3.1.16. *The inclusion induces a natural isomorphism*

$$H^i(\bar{X}, \Omega_{\bar{X}}^\bullet \langle D \rangle) \rightarrow H^i(X, \Omega_X^\bullet).$$

Proof. This is the algebraic version of [Del71, Proposition 3.1.8]. We indicate the argument. Note that $j : X \rightarrow \bar{X}$ is affine, hence j_* is exact and we have

$$H^i(X, \Omega_X^\bullet) \cong H^i(\bar{X}, j_* \Omega_X^\bullet).$$

It remains to show that

$$\iota : \Omega_{\bar{X}}^\bullet \langle D \rangle \rightarrow j_* \Omega_X^\bullet$$

is a quasi-isomorphism, or, equivalently, that $\text{Coker}(\iota)$ is exact. We can work in the étale topology by Lemma 3.1.14. It suffices to check exactness on stalks in geometric points of \bar{X} over closed points. As \bar{X} is smooth and D is a divisor with normal crossings, it suffices to consider the case $D = V(t_1 \dots t_r) \subset \mathbb{A}^n$ and the stalk in 0. As in the proof of the Poincaré lemma, it suffices to consider the case $n = 1$. If $r = 0$, then there is nothing to show.

It remains to consider the following situation: let $k = \bar{k}$ and \mathcal{O} be the henselisation of $k[t]$ with respect to the ideal (t) . We have to check that the complex

$$\mathcal{O}[t^{-1}]/\mathcal{O} \rightarrow \mathcal{O}[t^{-1}]/t^{-1}\mathcal{O}dt$$

is acyclic. The term in degree 0 has the \mathcal{O} -basis $\{t^{-i} | i > 0\}$. The term in degree 1 has the \mathcal{O} -basis $\{t^{-i}dt | i > 1\}$. In this basis, the differential has the form

$$\frac{f}{t^i} \mapsto \begin{cases} f' \frac{dt}{t^i} - i f \frac{dt}{t^{i+1}} & i > 1, \\ -f \frac{dt}{t^2} & i = 1. \end{cases}$$

It is injective because $\text{char}(k) = 0$. By induction on i we also check that it is surjective. \square

Corollary 3.1.17. *Let X be a smooth variety over k . Then the algebraic de Rham cohomology groups $H_{\text{dR}}^i(X)$ are finite-dimensional k -vector spaces.*

Proof. By resolution of singularities, we can embed X into a projective \bar{X} such that D is a divisor with simple normal crossings. By Proposition 3.1.16,

$$H_{\text{dR}}^i(X) = H^i(\bar{X}, \Omega_{\bar{X}}^\bullet \langle D \rangle).$$

Note that all $\Omega_{\bar{X}}^\bullet \langle D \rangle$ are coherent sheaves on a projective variety, hence the cohomology groups $H^p(\bar{X}, \Omega_{\bar{X}}^q \langle D \rangle)$ are finite-dimensional over k . We use the trivial filtration on $\Omega_{\bar{X}}^\bullet \langle D \rangle$ and the induced long exact cohomology sequence. By induction, all $H^q(\bar{X}, F^p \Omega_{\bar{X}}^\bullet \langle D \rangle)$ are finite-dimensional. \square

Remark 3.1.18. The complex of differentials with log poles is studied intensively in the theory of mixed Hodge structures. Indeed, Deligne uses it in [Del71] in order to define the Hodge and the weight filtration on the cohomology of a smooth variety X .

3.2 The general case: via the h-topology

We now want to extend the definition of algebraic de Rham cohomology to the case of singular varieties and even to the relative setting. The most simple-minded idea — using Definition 3.1.2 — does not give the desired dimensions. It is surprisingly difficult to write down an explicit counterexample. Neither the standard nodal curve nor the cuspidal curve $Y^2 = X^3$ are counterexamples.

Example 3.2.1 (Arapura–Kang). By [AK11, Example 4.4], the dimension of the first naive de Rham cohomology group of the singular planar curve given by the equation

$$X^5 + Y^5 + X^2Y^2 = 0$$

is strictly bigger than the dimension of the first singular cohomology.

There are different ways of adapting the definition in order to get a well-behaved theory.

The h-topology introduced by Voevodsky makes the handling of singular varieties straightforward. In this topology, any variety is locally smooth by

resolution of singularities. The h-sheafification of the presheaf of Kähler differentials was studied in detail by Huber and Jörder in [HJ14]. The weaker notion of eh-differential had already been introduced by Geisser in [Gei06].

We review a definition given by Voevodsky in [Voe96].

Definition 3.2.2 ([Voe96, Section 3.1]). A morphism of schemes $p : X \rightarrow Y$ is called a *topological epimorphism* if the topology on Y is the quotient topology with respect to p . It is a *universal topological epimorphism* if any base change of p is a topological epimorphism.

The h-topology on the category $(\text{Sch}/X)_h$ of separated schemes of finite type over X is the Grothendieck topology with coverings finite families $\{p_i : U_i \rightarrow Y\}$ such that $\bigcup_i U_i \rightarrow Y$ is a universal topological epimorphism.

By [Voe96], the following are h-covers:

1. flat covers with finite index set (in particular étale covers);
2. proper surjective morphisms;
3. quotients by finite group actions.

For all $X \in \text{Sch}/k$, the natural reduction map $X^{\text{red}} \rightarrow X$ is not only an h-cover, but for all h-sheaves \mathcal{F} we have $\mathcal{F}(X) = \mathcal{F}(X^{\text{red}})$.

The assignment $X \mapsto \Omega_{X/k}^p(X)$ is a presheaf on Sch/k . We denote by Ω_h^p (resp. $\Omega_{h/X}^p$, if X needs to be specified) its sheafification in the h-topology, and by $\Omega_h^p(X)$ its value as an abelian group.

Definition 3.2.3. Let X be a separated k -scheme of finite type over k . We define

$$H_{\text{dR}}^i(X_h) = H^i((\text{Sch}/X)_h, \Omega_h^\bullet).$$

Proposition 3.2.4 ([HJ14, Theorem 3.6, Proposition 7.4]). *Let X be smooth over k . Then*

$$\Omega_h^p(X) = \Omega_{X/k}^p(X)$$

and

$$H_{\text{dR}}^i(X_h) = H_{\text{dR}}^i(X).$$

Proof. The statement on $\Omega_h^p(X)$ is [HJ14, Theorem 3.6]. The statement on the de Rham cohomology is loc. cit. Proposition 7.4., together with the comparison of loc. cit. Lemma 7.22. \square

Remark 3.2.5. The main ingredients of the proof are a normal form for h-covers established by Voevodsky in [Voe96, Theorem 3.1.9], an explicit computation for the blow-up of a smooth variety in a smooth center and étale descent for the coherent sheaves $\Omega_{Y/k}^p$.

A particular useful example of an h-cover are *abstract blow-ups*, i.e., covers of the form $(f : X' \rightarrow X, i : Z \rightarrow X)$ where Z is a closed immersion and f is proper and an isomorphism above $X - Z$.

Then, the above implies that there is a long exact blow-up sequence

$$\cdots \rightarrow H_{\mathrm{dR}}^i(X_{\mathrm{h}}) \rightarrow H_{\mathrm{dR}}^i(X'_{\mathrm{h}}) \oplus H_{\mathrm{dR}}^i(Z_{\mathrm{h}}) \rightarrow H_{\mathrm{dR}}^i(f^{-1}(Z)_{\mathrm{h}}) \rightarrow \cdots$$

Definition 3.2.6. Let $X \in \mathrm{Sch}$ and $i : Z \rightarrow X$ a closed subscheme. Put

$$\Omega_{\mathrm{h}/(X,Z)}^p = \mathrm{Ker}(\Omega_{\mathrm{h}/X}^p \rightarrow i_*\Omega_{\mathrm{h}/Z}^p)$$

in the category of abelian sheaves on $(\mathrm{Sch}/X)_{\mathrm{h}}$.

We define *relative algebraic de Rham cohomology* as

$$H_{\mathrm{dR}}^p(X, Z) = H_{\mathrm{h}}^p(X, \Omega_{\mathrm{h}/(X,Z)}^\bullet).$$

Lemma 3.2.7 ([HJ14, Lemma 7.26]). *Let $i : Z \rightarrow X$ be a closed immersion.*

1. *Then*

$$Ri_*\Omega_{\mathrm{h}/Z}^p \cong i_*\Omega_{\mathrm{h}/Z}^p$$

and hence

$$H_{\mathrm{h}}^q(X, i_*\Omega_{\mathrm{h}/Z}^p) \cong H_{\mathrm{h}}^q(Z, \Omega_{\mathrm{h}}^p).$$

2. *The natural map of sheaves of abelian groups on $(\mathrm{Sch}/X)_{\mathrm{h}}$*

$$\Omega_{\mathrm{h}/X}^p \rightarrow i_*\Omega_{\mathrm{h}/Z}^p$$

is surjective.

Remark 3.2.8. The main ingredient of the proof is resolution of singularities and the computation of $\Omega_{\mathrm{h}}^p(Z)$ for Z a divisor with normal crossings: it is given as Kähler differentials modulo torsion, see [HJ14, Proposition 4.9].

Proposition 3.2.9 (Long exact sequence, [HJ14, Proposition 2.7]). *Let $Z \subset Y \subset X$ be closed immersions. Then there is a natural long exact sequence*

$$\cdots \rightarrow H_{\mathrm{dR}}^q(X, Y) \rightarrow H_{\mathrm{dR}}^q(X, Z) \rightarrow H_{\mathrm{dR}}^q(Y, Z) \rightarrow H_{\mathrm{dR}}^{q+1}(X, Y) \rightarrow \cdots$$

Remark 3.2.10. The sequence is the long exact cohomology sequence attached to the exact sequence of h-sheaves on X

$$0 \rightarrow \Omega_{\mathrm{h}/(X,Y)}^p \rightarrow \Omega_{\mathrm{h}/(X,Z)}^p \rightarrow i_{Y*}\Omega_{\mathrm{h}/(Y,Z)}^p \rightarrow 0,$$

where $i_Y : Y \rightarrow X$ is the closed immersion.

Proposition 3.2.11 (Excision, [HJ14, Proposition 7.28]). *Let $\pi : \tilde{X} \rightarrow X$ be a proper surjective morphism, which is an isomorphism outside of $Z \subset X$. Let $\tilde{Z} = \pi^{-1}(Z)$. Then*

$$H_{\mathrm{dR}}^q(\tilde{X}, \tilde{Z}) \cong H_{\mathrm{dR}}^q(X, Z).$$

Remark 3.2.12. This is an immediate consequence of the blow-up triangle.

Proposition 3.2.13 (Künneth formula, [HJ14, Proposition 7.29]). *Let $Z \subset X$ and $Z' \subset X'$ be closed immersions. Then there is a natural isomorphism*

$$H_{\mathrm{dR}}^n(X \times X', X \times Z' \cup Z \times X') \cong \bigoplus_{a+b=n} H_{\mathrm{dR}}^a(X, Z) \otimes_k H_{\mathrm{dR}}^b(X', Z').$$

Proof. We explain the construction of the map. We work in the category of h-sheaves of k -vector spaces on $X \times X'$. Note that the h-cohomology of an h-sheaf of k -vector spaces computed in the category of sheaves of abelian groups agrees with its h-cohomology computed in the category of sheaves of k -vector spaces because an injective sheaf of k -vector spaces is also injective as sheaf of abelian groups.

We abbreviate $T = X \times Z' \cup Z \times X'$. By h-sheafification of the product of Kähler differentials, we have a natural multiplication

$$\mathrm{pr}_X^* \Omega_{\mathrm{h}/X}^a \otimes_k \mathrm{pr}_{X'}^* \Omega_{\mathrm{h}/X'}^b \rightarrow \Omega_{\mathrm{h}/X \times X'}^{a+b}.$$

It induces, with $i_Z : Z \rightarrow X$, $i_{Z'} : Z' \rightarrow X'$, and $i : T \rightarrow X \times X'$

$$\begin{array}{c} \mathrm{pr}_X^* \mathrm{Ker}(\Omega_{\mathrm{h}/X}^a \rightarrow i_{Z*} \Omega_{\mathrm{h}/Z}^a) \otimes_k \mathrm{pr}_{X'}^* \mathrm{Ker}(\Omega_{\mathrm{h}/X'}^b \rightarrow i_{Z'*} \Omega_{\mathrm{h}/Z'}^b) \\ \downarrow \\ \mathrm{Ker}(\Omega_{\mathrm{h}/X \times X'}^{a+b} \rightarrow i_* \Omega_{\mathrm{h}/T}^{a+b}). \end{array}$$

The resulting morphism

$$\mathrm{pr}_X^* \Omega_{\mathrm{h}/(X,Z)}^\bullet \otimes_k \mathrm{pr}_{X'}^* \Omega_{\mathrm{h}/(X',Z')}^\bullet \rightarrow \Omega_{\mathrm{h}/(X \times X', T)}^\bullet$$

induces a natural Künneth morphism

$$\bigoplus_{a+b=n} H_{\mathrm{dR}}^a(X, Z) \otimes_k H_{\mathrm{dR}}^b(X', Z') \rightarrow H_{\mathrm{dR}}^n(X \times X', T).$$

We refer to the proof of [HJ14, Proposition 7.29] for the argument that this is an isomorphism. \square

Lemma 3.2.14. *Let K/k be an extension of fields of characteristic zero. Let X be a variety over k and $Z \subset X$ a subvariety. Then there are natural isomorphisms*

$$H_{\mathrm{dR}}^i(X, Z) \otimes_k K \rightarrow H_{\mathrm{dR}}^i(X_K, Z_K).$$

They are induced by a natural quasi-isomorphism

$$R\Gamma_{\mathrm{dR}}(X) \otimes_k K \rightarrow R\Gamma_{\mathrm{dR}}(X_K).$$

Proof. Via the long exact cohomology sequence for pairs, and the long exact sequence for a blow-up, it suffices to consider the case when X is a single smooth variety, where it follows from Lemma 3.1.11. \square

Lemma 3.2.15. *Let K/k be a finite extension of fields of characteristic 0. Let Y be variety over K and $W \subset Y$ a subvariety. We denote by Y_k and W_k the same varieties when considered over k .*

Then there are natural isomorphisms

$$H_{\mathrm{dR}}^i(Y, W) \rightarrow H_{\mathrm{dR}}^i(Y_k, W_k).$$

They are induced by a natural quasi-isomorphism

$$R\Gamma_{\mathrm{dR}}(Y_{\mathrm{h}}) \rightarrow R\Gamma_{\mathrm{dR}}((Y_K)_{\mathrm{h}}).$$

Proof. Note that if a variety is smooth over K , then it is also smooth when viewed over k .

The morphism on cohomology is induced by a morphism of sites from the category of k -varieties over Y to the category of K -varieties over k , both equipped with the h -topology. The pull-back of the de Rham complex over Y maps to the de Rham complex over Y_k . As in the proof of Lemma 3.2.14, via the long exact sequence for pairs and the blow-up sequence, it suffices to show the isomorphism for a single smooth Y . This was settled in Lemma 3.1.13. \square

3.3 The general case: alternative approaches

We are now going to present a number of earlier definitions of algebraic de Rham cohomology for singular varieties in the literature. They all give the same results in the cases where they are defined.

3.3.1 Deligne's method

We present the approach to de Rham cohomology of singular varieties used by Deligne in [Del74b]. A singular variety is replaced by a suitable simplicial variety whose terms are smooth.

3.3.1.1 Hypercovers

See Section 1.5 for the basics on simplicial objects. In particular, we have the notion of an S -hypercove for a class S of covering maps of varieties.

We will need two cases:

1. S is the class of open covers, i.e., $X = \coprod_{i=1}^n U_i$ with $U_i \subset Y$ open and such that $\bigcup_{i=1}^n U_i = Y$.
2. S is the class of proper surjective maps.

Lemma 3.3.1. *Let $X \rightarrow Y$ be in S . We put*

$$X_\bullet = \text{cosq}_0^Y X.$$

In explicit terms,

$$X_p = X \times_Y \cdots \times_Y X \quad (p+1 \text{ factors})$$

where we number the factors from 0 to p . The face map ∂_i is the projection forgetting the factor number i . The degeneration s_i is induced by the diagonal from the factor i into the factors i and $i+1$.

Then $X_\bullet \rightarrow Y$ is an S -hypercover.

Proof. By [AGV72] Exposé V, Proposition 7.1.2, the morphism

$$\text{cosq}_0 \rightarrow \text{cosq}_{n-1} \text{sq}_{n-1} \text{cosq}_0$$

is an isomorphism of functors for $n \geq 1$. Indeed, this follows directly from the adjunction properties of the coskeleton functor for simplicial varieties. Hence the condition on X_n is satisfied trivially for $n \geq 1$. In degree 0 we consider

$$X_0 = X \rightarrow (\text{cosq}_{-1}^Y \text{sq}_{-1} \text{cosq}_0^Y)_0 = Y.$$

By assumption, it is in S . □

It is worth spelling this out in complete detail in two special cases.

Example 3.3.2. Let $X = \prod_{i=1}^n U_i$ with $U_i \subset Y$ open. For $i_0, \dots, i_p \in \{1, \dots, n\}$ we abbreviate

$$U_{i_0, \dots, i_p} = U_{i_0} \cap \cdots \cap U_{i_p}.$$

Then the open hypercover X_\bullet is nothing but

$$X_p = \prod_{i_0, \dots, i_p=1}^n U_{i_0, \dots, i_p}$$

with face and degeneracy maps given by the natural inclusions. Let \mathcal{F} be a sheaf of abelian groups on X . Then the complex associated to the cosimplicial abelian group $\mathcal{F}(X_\bullet)$ is given by

$$\bigoplus_{i=1}^n \mathcal{F}(U_i) \rightarrow \bigoplus_{i_0, i_1=1}^n \mathcal{F}(U_{i_0, i_1}) \rightarrow \bigoplus_{i_0, i_1, i_2=1}^n \mathcal{F}(U_{i_0, i_1, i_2}) \rightarrow \cdots$$

with differential

$$\delta^p(\alpha)_{i_0, \dots, i_p} = \sum_{j=0}^{p+1} (-1)^j \alpha_{i_0, \dots, \hat{i}_j, \dots, i_{p+1}} |_{U_{i_0, \dots, \hat{i}_j, \dots, i_{p+1}}},$$

i.e., the differential of the Čech complex. Indeed, the natural projection

$$\mathcal{F}(X_\bullet) \rightarrow C^\bullet(\mathfrak{U}, \mathcal{F})$$

to the Čech complex (see Definition 1.4.12) is a quasi-isomorphism.

Definition 3.3.3. We recall from Definition 1.5.8 that $X_\bullet \rightarrow Y_\bullet$ is a *smooth proper hypercover* if it is a proper hypercover with all X_n smooth.

Example 3.3.4. Let $Y = Y_1 \cup \cdots \cup Y_n$ with $Y_i \subset Y$ closed. For $i_0, \dots, i_p = 1, \dots, n$ put

$$Y_{i_0, \dots, i_p} = Y_{i_0} \cap \cdots \cap Y_{i_p}.$$

Assume that all Y_i and all Y_{i_0, \dots, i_p} are smooth.

Then $X = \coprod_{i=1}^n Y_i \rightarrow Y$ is proper and surjective. The proper hypercover X_\bullet is nothing but

$$X_n = \coprod_{i_0, \dots, i_n=1}^n Y_{i_0} \cap \cdots \cap Y_{i_n}$$

with face and degeneracy maps given by the natural inclusions. Hence $X_\bullet \rightarrow Y$ is a smooth proper hypercover. As in the open case, the projection to the Čech complex of the closed cover $\mathfrak{Y} = \{Y_i\}_{i=1}^n$ is a quasi-isomorphism.

Proposition 3.3.5. *Let Y_\bullet be a simplicial variety over a perfect field. Then the system of all proper hypercovers of Y_\bullet is filtered up to simplicial homotopy. It is functorial in Y_\bullet . The subsystem of smooth proper hypercovers is cofinal.*

Proof. The first statement is [AGV72], Exposé V, Théorème 7.3.2. For the second assertion, it suffices to construct a smooth proper hypercover for any Y_\bullet . Recall that by Hironaka's resolution of singularities [Hir64], or by de Jong's theorem on alterations [dJ96], we have, for any variety Y , a proper surjective map $X \rightarrow Y$ with X smooth. By the technique of [AGV72], Exposé Vbis, Proposition 5.1.3 (see also [Del74b, 6.2.5]), this allows us to construct X_\bullet . \square

3.3.1.2 Definition of de Rham cohomology in the general case

Let again k be a field of characteristic 0.

Definition 3.3.6. Let X be a variety over k and $X_\bullet \rightarrow X$ a smooth proper hypercover. Let $C(X_\bullet) \in \mathbb{Z}[\text{Sm}]$ be the associated complex. We define *Deligne's algebraic de Rham cohomology* of X by

$$H_{\text{dR}}^i(X) = H^i(R\Gamma_{\text{dR}}(X_\bullet))$$

with $R\Gamma_{\text{dR}}$ as in Definition 3.1.7. Let $D \subset X$ be a closed subvariety and $D_\bullet \rightarrow D$ a smooth proper hypercover such that there is a commutative diagram

$$\begin{array}{ccc} D_{\bullet} & \longrightarrow & X_{\bullet} \\ \downarrow & & \downarrow \\ D & \longrightarrow & X \end{array}$$

We define *Deligne's relative algebraic de Rham cohomology* of the pair (X, D) by

$$H_{\mathrm{dR}}^i(X, D) = H^i(\mathrm{Cone}(R\Gamma_{\mathrm{dR}}(X_{\bullet}) \rightarrow R\Gamma_{\mathrm{dR}}(D_{\bullet}))[-1]).$$

Note that such hypercovers exist by Proposition 3.3.5.

Proposition 3.3.7. *Deligne's algebraic de Rham cohomology agrees with algebraic de Rham cohomology in the sense of Definitions 3.2.3 and 3.2.6. In particular, it is a well-defined functor, independent of the choice of hypercoverings of X and D .*

Remark 3.3.8. It is only the cohomology, not the complex $R\Gamma_{\mathrm{dR}}$, which is well-defined. The above construction defines a functor

$$R\Gamma_{\mathrm{dR}} : \mathrm{Var} \rightarrow K^+(k\text{-Vect})$$

but *not* to $C^+(k\text{-Vect})$. Hence it does *not* extend directly to $C^b(\mathbb{Q}[\mathrm{Var}])$. We avoid addressing this point by the use of the h-topology instead.

Proof. This is a special case of descent for h-covers and hence a consequence of Proposition 3.2.4.

Alternatively, we can deduce it from the case of singular cohomology. Recall that algebraic de Rham cohomology is well-behaved with respect to extensions of the ground field. Without loss of generality, we may assume that k is finitely generated over \mathbb{Q} and hence embeds into \mathbb{C} . Then we apply the period isomorphism of Definition 5.3.1. It remains to check the analogue for singular cohomology. This is Theorem 2.7.6. \square

Example 3.3.9. Let X be a smooth affine variety and D a divisor with simple normal crossings. Let D_1, \dots, D_n be the irreducible components. Let X_{\bullet} be the constant simplicial variety X and D_{\bullet} as in Example 3.3.4. Then Deligne's algebraic de Rham cohomology of D is computed by the total complex of the double complex (D_{i_0, \dots, i_p} being the $(p+1)$ -fold intersection of components)

$$K^{p,q} = \bigoplus_{i_0 < \dots < i_p} \Omega_{D_{i_0, \dots, i_p}}^q(D_{i_0, \dots, i_p})$$

with differential $d_1^{p,q} = \sum_{j=0}^p (-1)^j \partial_j^*$ the Čech differential and $d_2^{p,q}$ differentiation of differential forms.

Relative algebraic de Rham cohomology of (X, D) is computed by the total complex of the double complex

$$L^{p,q} = \begin{cases} K^{p-1,q} & p > 0, \\ \Omega_X^q(X) & p = 0. \end{cases}$$

Remark 3.3.10. Establishing the expected properties of relative algebraic de Rham cohomology in Deligne’s definition is lengthy. Particularly complicated is the handling of the multiplicative structure which uses the functor between complexes in $\mathbb{Z}[\text{Sm}]$ and simplicial objects in $\mathbb{Z}[\text{Sm}]$ and the product for simplicial objects. We do not go into the details but rely on the comparison with h-cohomology instead.

3.3.2 Hartshorne’s method

We want to review Hartshorne’s definition from [Har75]. As before let k be a field of characteristic 0.

Definition 3.3.11. Let X be a smooth variety over k and $Y \hookrightarrow X$ a closed subvariety. We define *Hartshorne’s algebraic de Rham cohomology* of Y as

$$H_{\text{dR}}^i(Y) = H^i(\hat{X}, \hat{\Omega}_X^\bullet),$$

where \hat{X} is the formal completion of X along Y and $\hat{\Omega}_X^\bullet$ the formal completion of the complex of algebraic differential forms on X . We refer to loc. cit. for the definition of these completions.

Proposition 3.3.12 ([Har75, Theorem (1.4)]). *Let Y be as in Definition 3.3.11. Then Hartshorne’s algebraic de Rham cohomology $H_{\text{dR}}^i(Y)$ is independent of the choice of X . In particular, if Y is smooth, the definition agrees with the one in Definition 3.1.2.*

Theorem 3.3.13. *The three definitions of algebraic de Rham cohomology*

1. *Definition 3.3.6 via hypercovers,*
2. *Definition 3.3.11 via embedding into smooth varieties,*
3. *Definition 3.2.3 using the h-topology)*

agree.

Proof. We use the eh-topology that is mentioned at the beginning of this Section. The comparison of Hartshorne’s $H_{\text{dR}}^i(X)$ and $H_{\text{dR}}^i(X_{\text{eh}})$ is proved in [Gei06, Theorem 4.10]. This group agrees with $H_{\text{dR}}^i(X_{\text{h}})$ by [HJ14, Proposition 6.1]. By [HJ14, Proposition 7.4], it also agrees with the definition via hypercovers. \square

3.3.3 Using geometric motives

In Chapter 6 we are going to introduce the triangulated category of effective geometric motives $DM_{\text{gm}, \mathbb{Q}}^{\text{eff}}$ over k with coefficients in \mathbb{Q} . It is obtained

from $DM_{\text{gm}}^{\text{eff}}$ by tensoring all morphisms with \mathbb{Q} . We only review the most important properties here and refer to Chapter 6 for more details. For some of them, it is easier to work with the affine version.

The objects in $DM_{\text{gm},\mathbb{Q}}^{\text{eff}}$ are the same as the objects in $C^b(\text{SmCor}_{\mathbb{Q}})$ where $\text{SmCor}_{\mathbb{Q}}$ is the category of correspondences, see Section 1.1.

Lecomte and Wach in [LW09] explain how to define an operation of correspondences on $\Omega_X^\bullet(X)$. We give a quick survey of their method.

For any normal variety Z let $\Omega_Z^{p,**}$ be the \mathcal{O}_Z -double dual of the sheaf of p -differentials. This is nothing but the sheaf of *reflexive differentials* on Z .

If $Z' \rightarrow Z$ is a finite morphism between normal varieties which is generically Galois with covering group G , then by [Kni73]

$$\Omega_Z^{p,**}(Z) \cong \Omega_{Z'}^{p,**}(Z')^G.$$

Let X and Y be smooth varieties. Assume for simplicity that X and Y are connected. Let $\Gamma \in \text{Cor}(X, Y)$ be a prime correspondence, i.e., $\Gamma \subset X \times Y$ is an integral closed subvariety which is finite and dominant over X . Choose a finite $\tilde{\Gamma} \rightarrow \Gamma$ such that $\tilde{\Gamma}$ is normal and the covering $\tilde{\Gamma} \rightarrow X$ is generically Galois with covering group G . In this case, $X = \tilde{\Gamma}/G$. Hence the natural contravariant functoriality induces for $\Gamma \in \text{Cor}(X, Y)$

$$\Omega_Y^\bullet(Y) \rightarrow \Omega_{\tilde{\Gamma}}^\bullet(\tilde{\Gamma}) \rightarrow \Omega_{\tilde{\Gamma}}^{\bullet,**}(\tilde{\Gamma}) \xrightarrow{\frac{1}{|G|} \sum_{g \in G} g^*} \Omega_{\tilde{\Gamma}}^{\bullet,**}(\tilde{\Gamma})^G \cong \Omega_X^\bullet(X).$$

This can be sheafified. Applying Godement resolutions, we obtain

$$Gd_Y \Omega_Y^\bullet(Y) \rightarrow Gd_{\tilde{\Gamma}} \Omega_{\tilde{\Gamma}}^{\bullet,**}(\tilde{\Gamma}) \rightarrow Gd_X \Omega_X^\bullet(X).$$

Recall, see Lemma 3.1.6, that

$$Gd_X \Omega_X^\bullet(X) = R\Gamma_{\text{dR}}(X).$$

Hence:

Definition 3.3.14. For a correspondence $\Gamma \in \text{Cor}(X, Y)$ as above, we define

$$\Gamma^* : R\Gamma_{\text{dR}}(Y) \rightarrow R\Gamma_{\text{dR}}(X)$$

as the above composition.

This is well-defined and compatible with composition of correspondences. We can now define de Rham cohomology for complexes of correspondences.

Definition 3.3.15. Let $X_\bullet \in C^b(\mathbb{Q}[\text{Sm}])$. We define

$$R\Gamma_{\text{dR}}(X_\bullet) = \text{Tot} R\Gamma_{\text{dR}}(X_n)_{n \in \mathbb{Z}},$$

and

$$H_{\text{dR}}^i(X_\bullet) = H^i R\Gamma_{\text{dR}}(X_\bullet).$$

Note that there is a straight-forward functor $\text{Sm} \rightarrow \text{SmCor}_{\mathbb{Q}}$. It assigns an object to itself and a morphism to its graph. This induces

$$i : C^b(\mathbb{Q}[\text{Sm}]) \rightarrow DM_{\text{gm},\mathbb{Q}}^{\text{eff}}.$$

By construction,

$$f^* = \Gamma_f^* : \Omega_Y^\bullet(Y) \rightarrow \Omega_X^\bullet(X)$$

for any morphism $f : X \rightarrow Y$ between smooth affine varieties. Hence,

$$R\Gamma_{\text{dR}}(X_\bullet) = R\Gamma_{\text{dR}}(i(X_\bullet)),$$

where the left-hand side was defined in Definition 3.1.7.

Proposition 3.3.16 (Voevodsky). *The functor i extends naturally to a functor*

$$i : C^b(\mathbb{Q}[\text{Var}]) \rightarrow DM_{\text{gm},\mathbb{Q}}^{\text{eff}}.$$

Proof. The category of geometric motives is a localisation of $K^b(\text{SmCor}_{\mathbb{Q}})$. It is easy to see that $R\Gamma_{\text{dR}}$ passes to the localisation.

The extension to all varieties is a highly non-trivial result of Voevodsky. By [VSF00, Chapter V, Corollary 4.1.4], there is functor

$$\text{Var} \rightarrow DM_{\text{gm},\mathbb{Q}}^{\text{eff}}.$$

Indeed, the functor

$$X \mapsto C_*L(X)$$

of loc. cit., Section 4.1, which assigns to every variety a homotopy invariant complex of Nisnevich sheaves, extends to $C^b(\mathbb{Q}[\text{Var}])$ by taking total complexes. We consider it in the derived category of Nisnevich sheaves. Then the functor factors via the homotopy category $K^b(\mathbb{Q}[\text{Var}])$.

By induction on the length of the complex, it follows from the result quoted above that $C_*L(\cdot)$ takes values in the full subcategory of geometric motives. \square

Definition 3.3.17. Let $D \subset X$ be a closed immersion of varieties. We define

$$H_{\text{dR}}^i(X, D) = H^i R\Gamma_{\text{dR}}(i([D \rightarrow X])),$$

where $[D \rightarrow X] \in C^b(\mathbb{Z}[\text{Var}])$ is concentrated in degrees -1 and 0 .

Proposition 3.3.18. *This definition agrees with the one given in Definition 3.3.6.*

Proof. The easiest way to formulate the proof is to invoke another variant of the category of geometric motives. It does not need transfers, but imposes h-descent instead. Scholbach [Sch12b, Definition 3.10] defines the category $DM_{\text{gm},h}^{\text{eff}}$ as the localisation of $K^-(\mathbb{Q}[\text{Var}])$ with respect to the triangulated subcategory generated by complexes of the form $X \times \mathbb{A}^1 \rightarrow X$ and

h-hypercovers $X_\bullet \rightarrow X$ and closed under certain infinite sums. By definition of $DM_{\text{gm},h}^{\text{eff}}$, any hypercovering $X_\bullet \rightarrow X$ induces an isomorphism of the associated complexes in $DM_{\text{gm},h}^{\text{eff}}$. By resolution of singularities, any object of $DM_{\text{gm},h}^{\text{eff}}$ is isomorphic to an object where all components are smooth. Hence we can replace $K^-(\mathbb{Q}[\text{Var}])$ by $K^-(\mathbb{Q}[\text{Sm}])$ in the definition without any change. We have seen how algebraic de Rham cohomology is defined on $K^-(\mathbb{Q}[\text{Sm}])$. By homotopy invariance (Corollary 3.1.10) and h-descent of the de Rham complex (Proposition 3.3.7), the definition of algebraic de Rham cohomology factors via $DM_{\text{gm},h}^{\text{eff}}$.

This gives a definition of algebraic de Rham cohomology for $K^-(\mathbb{Q}[\text{Var}])$ which by construction agrees with the one in Definition 3.3.6. On the other hand, the main result of [Sch12b] is that $DM_{\text{gm},\mathbb{Q}}^{\text{eff}}$ can be viewed as a full subcategory of $DM_{\text{gm},h}^{\text{eff}}$. This inclusion maps the motive of a (possibly singular) variety in $DM_{\text{gm},h}^{\text{eff}}$ to the motive of the same variety in $DM_{\text{gm},\mathbb{Q}}^{\text{eff}}$. As the two definitions of algebraic de Rham cohomology of motives agree on motives of smooth varieties, they agree on all motives. \square

3.3.4 The case of divisors with normal crossings

We are going to need the following technical result in order to give a simplified description of periods.

Proposition 3.3.19. *Let X be a smooth affine variety of dimension d and $D \subset X$ a divisor with simple normal crossings. Then every class in $H_{\text{dR}}^d(X, D)$ is represented by some $\omega \in \Omega_X^d(X)$.*

The proof will be given at the end of this section.

Let $D = D_1 \cup \cdots \cup D_n$ be the decomposition into irreducible components. For $I \subset \{1, \dots, n\}$, let again

$$D_I = \bigcap_{i \in I} D_i.$$

Recall from Example 3.3.9 that the de Rham cohomology of (X, D) is computed by the total complex of

$$\Omega_X^\bullet(X) \rightarrow \bigoplus_{i=1}^n \Omega_{D_i}^\bullet(D_i) \rightarrow \bigoplus_{i < j} \Omega_{D_{i,j}}^\bullet(D_{i,j}) \rightarrow \cdots \rightarrow \Omega_{D_{1,2,\dots,n}}^\bullet(D_{1,2,\dots,n}).$$

Note that D_I has dimension $d - |I|$, hence the double complex is concentrated in degrees $p, q \geq 0, p + q \leq d$. By definition, the classes in the top cohomology group $H_{\text{dR}}^d(X, D)$ are represented by tuples

$$(\omega_0, \omega_1, \dots, \omega_n), \quad \omega_0 \in \Omega_X^d(X), \omega_i \in \bigoplus_{|I|=i} \Omega_{D_I}^{d-i}(D_I), i > 0.$$

All such tuples are cocycles for dimension reasons. We have to show that, modulo coboundaries, we can assume $\omega_i = 0$ for all $i > 0$.

Lemma 3.3.20. *The restriction maps*

$$\begin{aligned} \Omega_X^{d-1}(X) &\rightarrow \bigoplus_{i=1}^n \Omega_{D_i}^{d-1}(D_i) \\ \bigoplus_{|I|=s} \Omega_{D_I}^{d-s-1}(D_I) &\rightarrow \bigoplus_{|J|=s+1} \Omega_{D_J}^{d-s-1}(D_J) \end{aligned}$$

are surjective.

Proof. Since X , and hence all D_i , are assumed affine, the global section functors are exact. Thus it suffices to check the assertion for the corresponding sheaves on X . As they are coherent, we can work locally for the étale topology. By replacing X by an étale neighbourhood of a point, we can assume that there is a global system of regular parameters t_1, \dots, t_d on X such that $D_i = \{t_i = 0\}$ for $i = 1, \dots, n$. First consider the case $s = 0$. The elements of $\Omega_{D_i}^{d-1}(D_i)$ are, without loss of generality, of the form $f_i dt_1 \wedge \dots \wedge \hat{dt}_i \wedge \dots \wedge dt_d$ (omitting the factor at i). Again by replacing X by an open subvariety, we can assume they are globally of this shape. The forms can all be lifted to X . The element

$$\omega = \sum_{i=1}^n f_i dt_1 \wedge \dots \wedge \hat{dt}_i \wedge \dots \wedge dt_d$$

is the preimage we were looking for.

For $s \geq 1$ we argue by induction on d and n . If $n = 1$, there is nothing to show. This settles the case $d = 1$. In general, we split the set of $I \subset \{1, \dots, n\}$ with $|I| = s$ into two subsets: the sets I containing n and the other ones that do not. We do the same with the set of $J \subset \{1, \dots, n\}$ with $|J| = s + 1$. This defines decompositions of source and target into direct sums. We get a commutative diagram of split exact sequences

$$\begin{array}{ccc}
0 & & 0 \\
\downarrow & & \downarrow \\
\bigoplus_{\substack{I \subset \{1, \dots, n\} \\ |I|=s, n \in I}} \Omega_{D_I}^{d-s-1}(D_I) & \longrightarrow & \bigoplus_{\substack{J \subset \{1, \dots, n\} \\ |J|=s+1, n \in J}} \Omega_{D_J}^{d-s-1}(D_J) \\
\downarrow & & \downarrow \\
\bigoplus_{\substack{I \subset \{1, \dots, n\} \\ |I|=s}} \Omega_{D_I}^{d-s-1}(D_I) & \longrightarrow & \bigoplus_{\substack{J \subset \{1, \dots, n\} \\ |J|=s+1}} \Omega_{D_J}^{d-s-1}(D_J) \\
\downarrow & & \downarrow \\
\bigoplus_{\substack{I \subset \{1, \dots, n-1\} \\ |I|=s}} \Omega_{D_I}^{d-s-1}(D_I) & \longrightarrow & \bigoplus_{\substack{J \subset \{1, \dots, n-1\} \\ |J|=s+1}} \Omega_{D_J}^{d-s-1}(D_J) \\
\downarrow & & \downarrow \\
0 & & 0
\end{array}$$

The arrow on the top reproduces the assertion for X replaced by D_n and D replaced by $D_n \cap (D_1 \cup \dots \cup D_{n-1})$. By induction, it is surjective. The arrow on the bottom is surjective by induction on n . Hence, the arrow in the middle is surjective. \square

Proof of Proposition 3.3.19. Consider a cocycle $\omega = (\omega_0, \omega_1, \dots, \omega_n)$ as explained above. We argue by descending induction on the degree i . Consider $\omega_n \in \Omega_{D_{\{1, \dots, n\}}}^{d-n}(D_{\{1, \dots, n\}})$. By the lemma, there exists an element

$$\omega'_{n-1} \in \bigoplus_{|I|=n-1} \Omega_{D_I}^{d-n}(D_I)$$

such that $d_1 \omega'_{n-1} = \omega_n$. We replace ω by $\omega - d_1 \omega'_{n-1} \pm d_2 \omega'_{n-1}$ (depending on the signs in the double complex). By construction, its component in degree n vanishes.

Hence, without loss of generality, we have $\omega_n = 0$. Next, consider ω_{n-1} etc. \square

Chapter 4

Holomorphic de Rham cohomology

We are going to define a natural comparison isomorphism between algebraic de Rham cohomology and singular cohomology of varieties over the complex numbers with coefficients in \mathbb{C} . The link is provided by holomorphic de Rham cohomology, which we study in this chapter.

4.1 Holomorphic de Rham cohomology

Everything we did in the algebraic setting also works for complex manifolds; indeed, this is the older notion.

We write $\mathcal{O}_X^{\text{hol}}$ for the sheaf of holomorphic functions on a complex manifold X , and assume that the reader is familiar with this notion.

4.1.1 Definition

Definition 4.1.1. Let X be a complex manifold. Let Ω_X^1 be the sheaf of *holomorphic differentials* on X . For $p \geq 0$ let

$$\Omega_X^p = \bigwedge^p \Omega_X^1$$

be the exterior power in the category of $\mathcal{O}_X^{\text{hol}}$ -modules and (Ω_X^\bullet, d) the *holomorphic de Rham complex*.

The differential is defined as in the algebraic case, see Definition 3.1.1.

Definition 4.1.2. Let X be a complex manifold. We define *holomorphic de Rham cohomology* of X as the hypercohomology

$$H_{\text{dR}}^i(X) = H^i(X, \Omega_X^\bullet).$$

As in the algebraic case, de Rham cohomology is a contravariant functor. The exterior products induce a cup product.

Proposition 4.1.3 (Poincaré lemma). *Let X be a complex manifold. The natural map of sheaves $\mathbb{C} \rightarrow \mathcal{O}_X^{\text{hol}}$ induces an isomorphism*

$$H_{\text{sing}}^i(X, \mathbb{C}) \rightarrow H_{\text{dR}^{\text{an}}}^i(X).$$

Proof. By Theorem 2.2.5, we can compute singular cohomology as sheaf cohomology on X . It remains to show that the complex

$$0 \rightarrow \mathbb{C} \rightarrow \mathcal{O}_X^{\text{hol}} \rightarrow \Omega_X^1 \rightarrow \Omega_X^2 \rightarrow \dots$$

is exact. Let Δ be the open unit disc in \mathbb{C} . The question is local, hence we may assume that $X = \Delta^d$. There is a natural isomorphism

$$\Omega_{\Delta^d}^\bullet \cong (\Omega_\Delta^\bullet)^{\boxtimes d},$$

where the right-hand side means the exterior tensor product on the product space. Hence it suffices to treat the case $X = \Delta$. In this case we consider

$$0 \rightarrow \mathbb{C} \rightarrow \mathcal{O}^{\text{hol}}(\Delta) \rightarrow \mathcal{O}^{\text{hol}}(\Delta)dt \rightarrow 0.$$

The elements of $\mathcal{O}^{\text{hol}}(\Delta)$ are of the form $\sum_{i \geq 0} a_i t^i$ with radius of convergence at least 1. The differential has the form

$$\sum_{j \geq 0} a_j t^j \mapsto \sum_{j \geq 0} j a_j t^{j-1} dt.$$

The kernel is given by the constants. It is surjective because the antiderivative has the same radius of convergence as the original power series. \square

Proposition 4.1.4 (Künneth formula). *Let X, Y be complex manifolds. There is a natural multiplication induced by the wedge product of differential forms*

$$H_{\text{dR}^{\text{an}}}^i(X) \otimes_{\mathbb{C}} H_{\text{dR}^{\text{an}}}^j(Y) \rightarrow H_{\text{dR}^{\text{an}}}^{i+j}(X \times Y).$$

It induces an isomorphism

$$H_{\text{dR}^{\text{an}}}^n(X \times Y) \cong \bigoplus_{i+j=n} H_{\text{dR}^{\text{an}}}^i(X) \otimes_{\mathbb{C}} H_{\text{dR}^{\text{an}}}^j(Y).$$

Proof. The construction of the morphism is the same as in the algebraic case, see Proposition 3.1.9. The quasi-isomorphism $\mathbb{C} \rightarrow \Omega^\bullet$ is compatible with the exterior products. Hence the isomorphism reduces to the Künneth isomorphism for singular cohomology, see Proposition 2.4.1. \square

4.1.2 Holomorphic differentials with log poles

Let $j : X \rightarrow \bar{X}$ be an open immersion of complex manifolds. Assume that $D = \bar{X} \setminus X$ is a divisor with normal crossings, i.e., locally on \bar{X} there is a coordinate system (t_1, \dots, t_n) such that D is given as the set of zeroes of $t_1 t_2 \dots t_r$ with $0 \leq r \leq n$.

Definition 4.1.5. Let

$$\Omega_{\bar{X}}^1 \langle D \rangle \subset j_* \Omega_X^1$$

be the locally free $\mathcal{O}_{\bar{X}}$ -module with the following basis: if $U \subset X$ is an open subset with coordinates t_1, \dots, t_n and $D|_U$ is given by the equation $t_1 \dots t_r = 0$, then $\Omega_{\bar{X}}^1 \langle D \rangle|_U$ has $\mathcal{O}_U^{\text{hol}}$ -basis

$$\frac{dt_1}{t_1}, \dots, \frac{dt_r}{t_r}, dt_{r+1}, \dots, dt_n.$$

For $p > 1$ let

$$\Omega_{\bar{X}}^p \langle D \rangle = \bigwedge^p \Omega_{\bar{X}}^1 \langle D \rangle.$$

We call $\Omega_{\bar{X}}^\bullet \langle D \rangle$ the *complex of holomorphic differentials with log poles along D* .

Note that the differential of $j_* \Omega_X^\bullet$ respects $\Omega_{\bar{X}}^\bullet \langle D \rangle$, so that this is indeed a subcomplex.

Proposition 4.1.6. *The inclusion induces a natural isomorphism*

$$H^i(\bar{X}, \Omega_{\bar{X}}^\bullet \langle D \rangle) \rightarrow H^i(X, \Omega_X^\bullet).$$

This is [Del71, Proposition 3.1.8]. The algebraic analogue was treated in Proposition 3.1.16.

Proof. Note that $j : X \rightarrow \bar{X}$ is Stein, hence j_* is exact and we have

$$H^i(X, \Omega_X^\bullet) \cong H^i(\bar{X}, j_* \Omega_X^\bullet).$$

It remains to show that the inclusion

$$\iota : \Omega_{\bar{X}}^\bullet \langle D \rangle \rightarrow j_* \Omega_X^\bullet$$

is a quasi-isomorphism, or, equivalently, that $\text{Coker}(\iota)$ is exact. The statement is local, hence we may assume that \bar{X} is a coordinate polydisc and $D = V(t_1 \dots t_r)$. We consider the stalk in 0. The complexes are tensor products of the complexes in the 1-dimensional situation. Hence it suffices to consider the case $n = 1$. If $r = 0$, then there is nothing to show.

It remains to consider the following situation: let \mathcal{O}^{hol} be the ring of germs of holomorphic functions at $0 \in \mathbb{C}$ and \mathcal{K}^{hol} the ring of germs of holomorphic

functions with an isolated singularity at 0. The ring \mathcal{O}^{hol} is given by power series with a positive radius of convergence. The field \mathcal{K}^{hol} is given by Laurent series converging on some punctured neighbourhood $\{t \mid 0 < t < \epsilon\}$. We have to check that the complex

$$\mathcal{K}^{\text{hol}}/\mathcal{O}^{\text{hol}} \rightarrow (\mathcal{K}^{\text{hol}}/t^{-1}\mathcal{O}^{\text{hol}})dt$$

is acyclic.

We pass to the principal parts. The differential has the form

$$\sum_{j>0} a_j t^{-j} \mapsto \sum_{j>0} (-j) a_j t^{-j-1}.$$

It is obviously injective. For surjectivity, note that the antiderivative

$$\int : \sum_{j>1} b_j t^{-j} \mapsto \sum_{j>1} \frac{b_j}{-j+1} t^{-j+1}$$

maps convergent Laurent series to convergent Laurent series. \square

4.1.3 GAGA

We work over the field of complex numbers.

An affine variety $X \subset \mathbb{A}_{\mathbb{C}}^n$ is also a closed set in the analytic topology on \mathbb{C}^n . If X is smooth, the associated analytic space X^{an} in the sense of Section 1.2.1 is a complex submanifold. As in loc. cit., we denote by

$$\alpha : (X^{\text{an}}, \mathcal{O}_{X^{\text{an}}}^{\text{hol}}) \rightarrow (X, \mathcal{O}_X)$$

the map of locally ringed spaces. Note that any algebraic differential form is holomorphic, hence there is a natural morphism of complexes

$$\alpha^{-1} \Omega_X^{\bullet} \rightarrow \Omega_{X^{\text{an}}}^{\bullet}.$$

It induces

$$\alpha^* : H_{\text{dR}}^i(X) \rightarrow H_{\text{dR}^{\text{an}}}^i(X^{\text{an}}).$$

Proposition 4.1.7 (GAGA for de Rham cohomology). *Let X be a smooth variety over \mathbb{C} . Then the natural map*

$$\alpha^* : H_{\text{dR}}^i(X) \rightarrow H_{\text{dR}^{\text{an}}}^i(X^{\text{an}})$$

is an isomorphism.

If X is smooth and projective, by using the Hodge to de Rham spectral sequence this is a standard consequence of Serre's comparison result for the

cohomology of coherent sheaves (GAGA [Ser56]). We need to extend this to the open case.

Proof. Let $j : X \rightarrow \bar{X}$ be a compactification such that $D = \bar{X} \setminus X$ is a divisor with simple normal crossings. The change of topology map α also induces

$$\alpha^{-1} j_* \Omega_X^\bullet \rightarrow j_*^{\text{an}} \Omega_{\bar{X}^{\text{an}}}^\bullet$$

which respects differentials with log-poles, and hence induces:

$$\alpha^{-1} \Omega_{\bar{X}}^\bullet \langle D \rangle \rightarrow j_*^{\text{an}} \Omega_{\bar{X}^{\text{an}}}^\bullet \langle D^{\text{an}} \rangle.$$

Hence we get a commutative diagram

$$\begin{array}{ccc} H_{\text{dR}}^i(X) & \longrightarrow & H_{\text{dR}^{\text{an}}}^i(X^{\text{an}}) \\ \uparrow & & \uparrow \\ H^i(\bar{X}, \Omega_{\bar{X}}^\bullet \langle D \rangle) & \longrightarrow & H^i(\bar{X}^{\text{an}}, \Omega_{\bar{X}^{\text{an}}}^\bullet \langle D^{\text{an}} \rangle) \end{array}$$

By Proposition 3.1.16 in the algebraic, and Proposition 4.1.6 in the holomorphic case, the vertical maps are isomorphism. By considering the Hodge to de Rham spectral sequence attached to the trivial filtration on $\Omega_X^\bullet \langle D \rangle$, it suffices to show that

$$H^p(\bar{X}, \Omega_{\bar{X}}^q \langle D \rangle) \rightarrow H^p(\bar{X}^{\text{an}}, \Omega_{\bar{X}^{\text{an}}}^q \langle D^{\text{an}} \rangle)$$

is an isomorphism for all p, q . Note that \bar{X} is smooth, projective and $\Omega_{\bar{X}}^q \langle D \rangle$ is coherent. Its analytification $\alpha^{-1} \Omega_{\bar{X}}^q \langle D \rangle \otimes_{\alpha^{-1} \mathcal{O}_{\bar{X}}} \mathcal{O}_{\bar{X}^{\text{an}}}^{\text{hol}}$ is nothing but $\Omega_{\bar{X}^{\text{an}}}^q \langle D^{\text{an}} \rangle$. By GAGA, we have an isomorphism in cohomology. \square

4.2 Holomorphic de Rham cohomology via the h' -topology

We address the singular case via the h' -topology on (An/X) introduced in Definition 2.7.1.

4.2.1 h' -differentials

Definition 4.2.1. Let $\Omega_{h'}^p$ be the h' -sheafification of the presheaf

$$Y \mapsto \Omega_Y^p(Y)$$

on the category of complex analytic spaces An .

Theorem 4.2.2 (Jörder [Jör14]). *Let X be a complex manifold. Then*

$$\Omega_X^p(X) \cong \Omega_{h'}^p(X).$$

Proof. Jörder defines in [Jör14, Definition 1.4.1] what he calls h -differentials Ω_h^p as the presheaf pull-back of Ω^p from the category of manifolds to the category of complex analytic spaces. (There is no mention of a topology in loc. cit.) In [Jör14, Proposition 1.4.2 (4)] he establishes that $\Omega_h^p(X) \cong \Omega_X^p(X)$ in the smooth case. It remains to show that $\Omega_h^p \cong \Omega_{h'}^p$. By resolution of singularities, every X is smooth locally for the h' -topology. Hence it suffices to show that Ω_h^p is an h' -sheaf. By [Jör14, Lemma 1.4.5], the sheaf condition is satisfied for proper covers. The sheaf condition for open covers is satisfied because already Ω_X^p is a sheaf in the ordinary topology. \square

Lemma 4.2.3 (Poincaré lemma). *Let X be a complex analytic space. Then the complex*

$$\mathbb{C}_{h'} \rightarrow \Omega_{h'}^\bullet$$

of h' -sheaves on $(\text{An}/X)_{h'}$ is exact.

Proof. We may check this locally in the h' -topology. By resolution of singularities it suffices to consider sections over some Y which is smooth and even an open ball in \mathbb{C}^n . By Theorem 4.2.2 the complex reads

$$\mathbb{C} \rightarrow \Omega_Y^\bullet(Y).$$

By the ordinary holomorphic Poincaré Lemma 4.1.3, it is exact. \square

Remark 4.2.4. The main topic of Jörder's thesis [Jör14] is to treat the question of a Poincaré Lemma for h' -forms with respect to the usual topology rather than the h' -topology. This is more subtle and fails in general.

4.2.2 Holomorphic de Rham cohomology

We now turn to holomorphic de Rham cohomology.

Definition 4.2.5. Let X be a complex analytic space.

1. We define h' -de Rham cohomology as hypercohomology

$$H_{\text{dR}}^i(X_{h'}) = H_{h'}^i((\text{Sch}/X)_{h'}, \Omega_{h'}^\bullet).$$

2. Let $i : Z \rightarrow X$ be a closed subspace. Put

$$\Omega_{h'/(X,Z)}^p = \text{Ker}(\Omega_{h'/X}^p \rightarrow i_* \Omega_{h'/Z}^p)$$

in the category of abelian sheaves on $(\text{An}/X)_{h'}$.
We define *relative h' -de Rham cohomology* as

$$H_{\text{dR}^{\text{an}}}^p(X_{h'}, Z_{h'}) = H_{h'}^p((\text{An}/X)_{h'}, \Omega_{h'/(X,Z)}^*).$$

Lemma 4.2.6. *The properties (long exact sequence, excision, Künneth formula) of relative algebraic h' -de Rham cohomology (see Section 3.2) are also satisfied in relative h' -de Rham cohomology.*

Proof. The proofs are the same as in Section 3.2, respectively in [HJ14, Section 7.3]. They rely on the computation of $\Omega_{h'}^p(D)$ when D is a normal crossings space. Indeed, the same argument as in the proof of [HJ14, Proposition 4.9] shows that

$$\Omega_{h'}^p(D) = \Omega_D^p(D)/\text{torsion}.$$

□

As in the previous case, exterior multiplication of differential forms induces a product structure on h' -de Rham cohomology.

Corollary 4.2.7. *For all $X \in \text{An}$ and all closed immersions $i : Z \rightarrow X$ the inclusion of the Poincaré lemma induces a natural isomorphism*

$$H_{\text{sing}}^i(X, Z; \mathbb{C}) \rightarrow H_{\text{dR}^{\text{an}}}^i(X_{h'}, Z_{h'}),$$

compatible with long exact sequences and multiplication. Moreover, the natural map

$$H_{\text{dR}^{\text{an}}}^i(X_{h'}) \rightarrow H_{\text{dR}^{\text{an}}}^i(X)$$

is an isomorphism if X is smooth.

Proof. By the Poincaré Lemma 4.2.3, we have a natural isomorphism

$$H_{h'}^i(X_{h'}, Z_{h'}; \mathbb{C}_{h'}) \rightarrow H_{\text{dR}^{\text{an}}}^i(X_{h'}, Z_{h'}).$$

We combine it with the comparison isomorphism with singular cohomology of Proposition 2.7.4.

The second statement holds because both terms compute singular cohomology by Proposition 2.7.4 and Proposition 4.1.3. □

4.2.3 GAGA

We work over the base field \mathbb{C} . As before we consider the analytification functor

$$X \mapsto X^{\text{an}}$$

which takes a separated scheme of finite type over \mathbb{C} to a complex analytic space. We recall the map of locally ringed spaces

$$\alpha : X^{\text{an}} \rightarrow X.$$

We want to view it as a morphism of topoi

$$\alpha : (\text{An}/X^{\text{an}})_{h'} \rightarrow (\text{Sch}/X)_h.$$

Definition 4.2.8. Let $X \in \text{Sch}/\mathbb{C}$. We define the h' -topology on the category $(\text{Sch}/X)_{h'}$ to be the smallest Grothendieck topology such that the following are covering maps:

1. proper surjective morphisms;
2. open covers.

If \mathcal{F} is a presheaf on An/X , we denote by $\mathcal{F}_{h'}$ its sheafification in the h' -topology.

Lemma 4.2.9. *1. The morphism of sites $(\text{Sch}/X)_h \rightarrow (\text{Sch}/X)_{h'}$ induces an isomorphism on the categories of sheaves.
2. The analytification functor induces a morphism of sites*

$$(\text{An}/X^{\text{an}})_{h'} \rightarrow (\text{Sch}/X)_{h'}.$$

Proof. By [Voe96] Theorem 3.1.9 any h -cover can be refined by a cover in normal form, which is a composition of open immersions followed by proper maps. This proves the first assertion. The second is clear by construction. \square

By h' -sheafifying the natural morphism of complexes

$$\alpha^{-1}\Omega_X^\bullet \rightarrow \Omega_{X^{\text{an}}}^\bullet$$

of Section 4.1.3, we also obtain

$$\alpha^{-1}\Omega_h^\bullet \rightarrow \Omega_{h'}^\bullet$$

on $(\text{An}/X^{\text{an}})_{h'}$. It induces

$$\alpha^* : H_{\text{dR}}^i(X_h) \rightarrow H_{\text{dR}^{\text{an}}}^i(X_{h'}^{\text{an}}).$$

Proposition 4.2.10 (GAGA for h' -de Rham cohomology). *Let X be a variety over \mathbb{C} and Z a closed subvariety. Then the natural map*

$$\alpha^* : H_{\text{dR}}^i(X_h, Z_h) \rightarrow H_{\text{dR}^{\text{an}}}^i(X_{h'}^{\text{an}}, Z_{h'}^{\text{an}})$$

is an isomorphism. It is compatible with long exact sequences and products.

Proof. By naturality, the comparison morphism is compatible with long exact sequences. Hence it suffices to consider the absolute case.

Let $X_\bullet \rightarrow X$ be a smooth proper hypercover. This is a cover in the h' -topology, hence we may replace X by X_\bullet on both sides. As all components of X_\bullet are smooth, we may replace h -cohomology by Zariski-cohomology in the algebraic setting (see Proposition 3.2.4). On the analytic side, we may replace h' -cohomology by ordinary sheaf cohomology (see Corollary 2.7.4). The statement then follows from the assertion in the smooth case, see Proposition 4.1.7. \square

Chapter 5

The period isomorphism

The aim of this section is to define well-behaved isomorphisms between singular and de Rham cohomology of algebraic varieties.

5.1 The category $(k, \mathbb{Q})\text{-Vect}$

We introduce a category constructed with a bit of simple linear algebra which will later allow us to formalise the notion of periods. Throughout, let $k \subset \mathbb{C}$ be a subfield.

Definition 5.1.1. Let $(k, \mathbb{Q})\text{-Vect}$ be the category of triples $(V_k, V_{\mathbb{Q}}, \phi_{\mathbb{C}})$ where V_k is a finite-dimensional k -vector space, $V_{\mathbb{Q}}$ a finite-dimensional \mathbb{Q} -vector space and

$$\phi_{\mathbb{C}} : V_k \otimes_k \mathbb{C} \rightarrow V_{\mathbb{Q}} \otimes_{\mathbb{Q}} \mathbb{C}$$

a \mathbb{C} -linear comparison isomorphism. The morphisms in $(k, \mathbb{Q})\text{-Vect}$ are linear maps on V_k and $V_{\mathbb{Q}}$ compatible with the comparison isomorphisms.

Note that a morphism in this category is an isomorphism if and only if its \mathbb{Q} -component is. Note also that $(k, \mathbb{Q})\text{-Vect}$ is a \mathbb{Q} -linear abelian tensor category with the obvious notion of tensor product. It is rigid, i.e., all objects have strong duals. It is even Tannakian with projection to the \mathbb{Q} -component as fibre functor.

For later use, we make the duality explicit:

Remark 5.1.2. Let $V = (V_k, V_{\mathbb{Q}}, \phi_{\mathbb{C}}) \in (k, \mathbb{Q})\text{-Vect}$. Then the dual V^{\vee} is given by

$$V^{\vee} = (V_k^*, V_{\mathbb{Q}}^*, (\phi^*)^{-1})$$

where \cdot^* denotes the vector space dual over k and \mathbb{Q} or \mathbb{C} . Note that the inverse is needed in order to make the map go in the right direction.

Remark 5.1.3. The above is a simplification of the category of mixed Hodge structures introduced by Deligne, see [Del71]. It does not take the weight

and Hodge filtration into account. In other words: there is a faithful forgetful functor from mixed Hodge structures over k to $(k, \mathbb{Q})\text{-Vect}$.

Example 5.1.4. The invertible objects are those where V_k and $V_{\mathbb{Q}}$ have dimension one. Up to isomorphism they are of the form

$$L(\alpha) = (k, \mathbb{Q}, \alpha) \text{ with } \alpha \in \mathbb{C}^\times.$$

5.2 A triangulated category

We introduce a triangulated category with a t -structure whose heart is $(k, \mathbb{Q})\text{-Vect}$.

Definition 5.2.1. A *cohomological $(k, \mathbb{Q})\text{-Vect-complex}$* consists of the following data:

- a bounded below complex K_k^\bullet of k -vector spaces with finite-dimensional cohomology;
- a bounded below complex $K_{\mathbb{Q}}^\bullet$ of \mathbb{Q} -vector spaces with finite-dimensional cohomology;
- a bounded below complex $K_{\mathbb{C}}^\bullet$ of \mathbb{C} -vector spaces with finite-dimensional cohomology;
- a quasi-isomorphism $\phi_{k, \mathbb{C}} : K_k^\bullet \otimes_k \mathbb{C} \rightarrow K_{\mathbb{C}}^\bullet$;
- a quasi-isomorphism $\phi_{\mathbb{Q}, \mathbb{C}} : K_{\mathbb{Q}}^\bullet \otimes_{\mathbb{Q}} \mathbb{C} \rightarrow K_{\mathbb{C}}^\bullet$.

Morphisms of cohomological $(k, \mathbb{Q})\text{-Vect-complexes}$ are given by triples of morphisms of complexes on the k -, \mathbb{Q} - and \mathbb{C} -components such that the obvious diagrams commute. We denote the category of cohomological $(k, \mathbb{Q})\text{-Vect-complexes}$ by $C_{(k, \mathbb{Q})}^+$.

Let K and L be objects of $C_{(k, \mathbb{Q})}^+$. A *homotopy* from K and L is a homotopy in the k -, \mathbb{Q} - and \mathbb{C} -components compatible under the comparison maps. Two morphisms in $C_{(k, \mathbb{Q})}^+$ are *homotopic* if they differ by a homotopy. We denote by $K_{(k, \mathbb{Q})}^+$ the *homotopy category of cohomological $(k, \mathbb{Q})\text{-Vect-complexes}$* .

A morphism in $K_{(k, \mathbb{Q})}^+$ is called a *quasi-isomorphism* if its k -, \mathbb{Q} -, and \mathbb{C} -components are quasi-isomorphisms. We denote by $D_{(k, \mathbb{Q})}^+$ the localisation of $K_{(k, \mathbb{Q})}^+$ with respect to quasi-isomorphisms. It is called the *derived category of cohomological $(k, \mathbb{Q})\text{-Vect-complexes}$* .

Remark 5.2.2. This is a simplification of the category of mixed Hodge complexes introduced by Beilinson [Bei86]. A systematic study of this type of category can be found in [Hub95, §4]. In the language of loc. cit., it is the rigid glued category of the category of k -vector spaces and the category of \mathbb{Q} -vector spaces via the category of \mathbb{C} -vector spaces and the extension of scalars functors. Note that the comparison functors are exact, hence the construction simplifies.

Lemma 5.2.3. $D_{(k,\mathbb{Q})}^+$ is a triangulated category. It has a natural t -structure with

$$H^i : D_{(k,\mathbb{Q})}^+ \rightarrow (k, \mathbb{Q})\text{-Vect}$$

defined componentwise. The heart of the t -structure is $(k, \mathbb{Q})\text{-Vect}$.

Proof. This is more or less straightforward. For details, see [Hub95, §4]. \square

Remark 5.2.4. In [Hub95, 4.2, 4.3], explicit formulas are given for the morphisms in $D_{(k,\mathbb{Q})}^+$. The category has cohomological dimension 1. For $K, L \in (k, \mathbb{Q})\text{-Vect}$, the group $\text{Hom}_{D_{(k,\mathbb{Q})}^+}(K, L[1])$ is equal to the group of Yoneda extensions. As in [Bei86], this implies that $D_{(k,\mathbb{Q})}^+$ is equivalent to the bounded derived category $D^+((k, \mathbb{Q})\text{-Vect})$. We do not spell out the details because we are not going to need these properties.

There is an obvious definition of a tensor product on $C_{(k,\mathbb{Q})}^+$. Let $K^\bullet, L^\bullet \in C_{(k,\mathbb{Q})}^+$. We define $K^\bullet \otimes L^\bullet$ with $k, \mathbb{Q}, \mathbb{C}$ -components given by the tensor product of complexes of vector spaces over k, \mathbb{Q} , and \mathbb{C} , respectively (see Example 1.3.4). The tensor product of two quasi-isomorphisms defines the comparison isomorphism on the tensor product. It is associative and commutative.

Lemma 5.2.5. $C_{(k,\mathbb{Q})}^+, K_{(k,\mathbb{Q})}^+$ and $D_{(k,\mathbb{Q})}^+$ are associative and commutative tensor categories with the above tensor product. The cohomology functor H^* commutes with \otimes . For K^\bullet, L^\bullet in $D_{(k,\mathbb{Q})}^+$, we have a natural isomorphism

$$H^*(K^\bullet) \otimes H^*(L^\bullet) \rightarrow H^*(K^\bullet \otimes L^\bullet).$$

It is compatible with the associativity constraint. It is compatible with the commutativity constraint up to the sign $(-1)^{pq}$ on $H^p(K^\bullet) \otimes H^q(L^\bullet)$.

Proof. The case of $D_{(k,\mathbb{Q})}^+$ follows immediately from the case of complexes of vector spaces, where it is well-known. The signs come from the signs in the total complex of, in this case, a bicomplex, see Section 1.3.3. In this case, the bicomplex is the tensor product of complexes. \square

Remark 5.2.6. This is again simpler than the case treated in [Hub95, Chapter 13], because we do not need to control filtrations and because our tensor products are exact.

5.3 The period isomorphism in the smooth case

Let k be a subfield of \mathbb{C} . We consider smooth varieties over k and the complex manifold X^{an} associated to $X \times_k \mathbb{C}$.

Definition 5.3.1. Let X be a smooth variety over k . We define the *period isomorphism*

$$\text{per} : H_{\text{dR}}^*(X) \otimes_k \mathbb{C} \rightarrow H_{\text{sing}}^*(X, \mathbb{Q}) \otimes_{\mathbb{Q}} \mathbb{C}$$

to be the isomorphism given by the composition of the isomorphisms

1. $H_{\text{dR}}^*(X) \otimes_k \mathbb{C} \rightarrow H_{\text{dR}}^*(X \times_k \mathbb{C})$ of Lemma 3.1.11,
2. $H_{\text{dR}}^*(X \times_k \mathbb{C}) \rightarrow H_{\text{dR}^{\text{an}}}^*(X^{\text{an}})$ of Proposition 4.1.7,
3. the inverse of the map $H_{\text{sing}}^*(X^{\text{an}}) \rightarrow H_{\text{dR}^{\text{an}}}^*(X^{\text{an}}, \mathbb{C})$ from Proposition 4.1.3,
4. the inverse of the change-of-coefficients isomorphism $H_{\text{sing}}^*(X^{\text{an}}, \mathbb{C}) \rightarrow H_{\text{sing}}^*(X^{\text{an}}, \mathbb{Q}) \otimes_{\mathbb{Q}} \mathbb{C}$.

We define the *period pairing*

$$\text{per} : H_{\text{dR}}^*(X) \times H_*^{\text{sing}}(X^{\text{an}}, \mathbb{Q}) \rightarrow \mathbb{C}$$

to be the bilinear map

$$(\omega, \gamma) \mapsto \gamma(\text{per}(\omega)),$$

where we view classes in singular homology as linear forms on singular cohomology.

Remark 5.3.2. The choice of evaluating de Rham classes via singular homology seems more natural in our setting than the opposite choice, since there is no natural definition of de Rham homology.

Recall the category $(k, \mathbb{Q})\text{-Vect}$ introduced in Section 5.1.

Lemma 5.3.3. *The assignment*

$$X \mapsto (H_{\text{dR}}^*(X), H_{\text{sing}}^*(X), \text{per})$$

defines a functor

$$\mathbb{H} : \text{Sm} \rightarrow (k, \mathbb{Q})\text{-Vect}.$$

For all $X, Y \in \text{Sm}$, the Künneth isomorphism induces a natural isomorphism

$$\mathbb{H}(X) \otimes \mathbb{H}(Y) \rightarrow \mathbb{H}(X \times Y).$$

The image of \mathbb{H} is closed under direct sums and tensor products.

Proof. Functoriality holds by construction. The Künneth morphism is induced from the Künneth isomorphisms in singular cohomology (Proposition 2.4.1) and algebraic de Rham cohomology (see Proposition 3.1.9), respectively. All identifications in Definition 5.3.1 are compatible with the product structure. Hence we have defined a Künneth morphism in \mathbb{H} . It is an isomorphism because it is an isomorphism in singular cohomology.

Direct sums are realised by the disjoint union. The tensor product is realised by the product. \square

In Chapter 11, we are going to study systematically the notion of periods of objects in $H(\text{Sm})$.

The period isomorphism has an explicit description in terms of integration.

Theorem 5.3.4. *Let X be a smooth affine variety over k and $\omega \in \Omega^i(X)$ a closed differential form with de Rham class $[\omega]$. Let $c = \sum a_j \gamma_j$ be a singular homology class in $H_i^{\text{sing}}(X^{\text{an}}, \mathbb{Q})$, where $a_j \in \mathbb{Q}$ and $\gamma_j : \Delta_i \rightarrow X^{\text{an}}$ are differentiable singular cycles as in Definition 2.2.2. Then*

$$\text{per}([\omega], c) = \sum a_j \int_{\Delta_i} \gamma_j^*(\omega).$$

Remark 5.3.5. We could use the above formula as a definition of the period pairing, at least in the affine case. By Stokes' theorem, the value only depends on the classes of ω and γ .

Proof. Let $A^i(X^{\text{an}})$ be the group of \mathbb{C} -valued C^∞ -differential forms in degree i and $\mathcal{A}_{X^{\text{an}}}^i$ the associated sheaf. By the Poincaré lemma and its C^∞ -analogue, the morphisms

$$\mathbb{C} \rightarrow \Omega_{X^{\text{an}}}^\bullet \rightarrow \mathcal{A}_{X^{\text{an}}}^\bullet$$

are quasi-isomorphisms. Hence, the second map induces a quasi-isomorphism

$$\Omega_{X^{\text{an}}}^\bullet(X^{\text{an}}) \rightarrow A^\bullet(X^{\text{an}})$$

because both compute singular cohomology in the affine case. Hence it suffices to view ω as a C^∞ -differential form. By the Theorem of de Rham, see [War83, Sections 5.34-5.36], the period isomorphism is realised by integration over simplices. \square

Example 5.3.6. For $X = \mathbb{P}_k^n$, we have

$$H^{2j}(\mathbb{P}_k^n) = L((2\pi i)^j)$$

with $L(\alpha)$ the invertible object of Example 5.1.4.

5.4 The general case (via the h' -topology)

We generalise the period isomorphism to relative cohomology of arbitrary varieties.

Let k be a subfield of \mathbb{C} . We consider varieties over k and the complex analytic space X^{an} associated to $X \times_k \mathbb{C}$.

Definition 5.4.1. Let X be a variety over k , and $Z \subset X$ a closed subvariety. We define the *period isomorphism*

$$\text{per} : H_{\text{dR}}^*(X, Z) \otimes_k \mathbb{C} \rightarrow H_{\text{sing}}^*(X, Z; \mathbb{Q}) \otimes_{\mathbb{Q}} \mathbb{C}$$

to be the isomorphism given by the composition of the isomorphisms

1. $H_{\mathrm{dR}}^*(X, Z) \otimes_k \mathbb{C} \rightarrow H_{\mathrm{dR}}^*(X \times_k \mathbb{C}, Z \times_k \mathbb{C})$ of Lemma 3.2.14,
2. $H_{\mathrm{dR}}^*(X \times_k \mathbb{C}, Z \times_k \mathbb{C}) \rightarrow H_{\mathrm{dR}^{\mathrm{an}}}^*(X_{h'}^{\mathrm{an}}, Z_{h'}^{\mathrm{an}})$ of Proposition 4.2.10,
3. the inverse of the map $H_{\mathrm{sing}}^*(X_{h'}^{\mathrm{an}}, Z_{h'}^{\mathrm{an}}) \rightarrow H_{\mathrm{dR}^{\mathrm{an}}}^*(X^{\mathrm{an}}, Z^{\mathrm{an}}, \mathbb{C})$ from Corollary 4.2.7,
4. the inverse of the change-of-coefficients isomorphism $H_{\mathrm{sing}}^*(X^{\mathrm{an}}, Z^{\mathrm{an}}; \mathbb{C}) \rightarrow H_{\mathrm{sing}}^*(X^{\mathrm{an}}, Z^{\mathrm{an}}, \mathbb{Q}) \otimes_{\mathbb{Q}} \mathbb{C}$.

We define the *period pairing*

$$\mathrm{per} : H_{\mathrm{dR}}^*(X, Z) \times H_*^{\mathrm{sing}}(X^{\mathrm{an}}, Z^{\mathrm{an}}; \mathbb{Q}) \rightarrow \mathbb{C}$$

to be the map

$$(\omega, \gamma) \mapsto \gamma(\mathrm{per}(\omega)),$$

where we view classes in singular homology as linear forms on singular cohomology.

Lemma 5.4.2. *The assignment*

$$(X, Z) \mapsto (H_{\mathrm{dR}}^*(X, Z), H_{\mathrm{sing}}^*(X, Z), \mathrm{per})$$

defines a functor, denoted by \mathbf{H} , on the category of pairs $X \supset Z$ with values in $(k, \mathbb{Q})\text{-Vect}$. For all $Z \subset X$, $Z' \subset X'$, the Künneth isomorphism induces a natural isomorphism

$$\mathbf{H}(X, Z) \otimes \mathbf{H}(X', Z') \rightarrow \mathbf{H}(X \times X', X \times Z' \cup Z \times X').$$

The image of \mathbf{H} is closed under direct sums and tensor products.

If $Z \subset Y \subset X$ is a triple, then there is an induced long exact sequence in $(k, \mathbb{Q})\text{-Vect}$:

$$\dots \rightarrow H^i(X, Y) \rightarrow H^i(X, Z) \rightarrow H^i(Y, Z) \xrightarrow{\partial} H^{i+1}(X, Y) \rightarrow \dots$$

Proof. Functoriality and compatibility with long exact sequences hold by construction. The Künneth morphism is induced from the Künneth isomorphism in singular cohomology (Proposition 2.4.1) and algebraic de Rham cohomology (see Proposition 3.1.9). All identifications in Definition 5.3.1 are compatible with the product structure. Hence we have defined a Künneth morphism in \mathbf{H} . It is an isomorphism because it is an isomorphism in singular cohomology.

The direct sum is realised by the disjoint union. The tensor product is realised by the product. \square

5.5 The general case (Deligne's method)

We explain an alternative approach to generalising the period isomorphism to relative cohomology of arbitrary varieties. It is based on Deligne's definition of algebraic de Rham cohomology, see Section 3.3.1.

Let k be a subfield of \mathbb{C} .

Recall from Section 3.1.2 the functor

$$R\Gamma_{\mathrm{dR}} : \mathbb{Z}[\mathrm{Sm}] \rightarrow C^+(k\text{-Mod})$$

which maps a smooth variety to a natural complex computing its de Rham cohomology. In the same way, we define, using the Godement resolution of Definition 1.4.8, a functor

$$R\Gamma_{\mathrm{sing}}(X) = \Gamma(X^{\mathrm{an}}, Gd(\mathbb{Q})) \in C^+(\mathbb{Q}\text{-Mod}),$$

a complex computing the singular cohomology of X^{an} . Moreover, let

$$R\Gamma_{\mathrm{dR}^{\mathrm{an}}}(X) = \Gamma(X^{\mathrm{an}}, Gd(\Omega_{X^{\mathrm{an}}}^{\bullet})) \in C^+(\mathbb{C}\text{-Mod})$$

be a complex computing the holomorphic de Rham cohomology of X^{an} .

Lemma 5.5.1. *Let X be a smooth variety over k .*

1. *As before, let $\alpha : X^{\mathrm{an}} \rightarrow X \times_k \mathbb{C}$ be the morphism of locally ringed spaces and $\beta : X \times_k \mathbb{C} \rightarrow X$ the natural map. The inclusion $\alpha^{-1}\beta^{-1}\Omega_X^{\bullet} \rightarrow \Omega_{X^{\mathrm{an}}}^{\bullet}$ induces a natural quasi-isomorphism of complexes*

$$\phi_{\mathrm{dR}, \mathrm{dR}^{\mathrm{an}}} : R\Gamma_{\mathrm{dR}}(X) \otimes_k \mathbb{C} \rightarrow R\Gamma_{\mathrm{dR}^{\mathrm{an}}}(X).$$

2. *The inclusion $\mathbb{Q} \rightarrow \Omega_{X^{\mathrm{an}}}^{\bullet}$ induces a natural quasi-isomorphism of complexes*

$$\phi_{\mathrm{sing}, \mathrm{dR}^{\mathrm{an}}} : R\Gamma_{\mathrm{sing}}(X) \otimes_{\mathbb{Q}} \mathbb{C} \rightarrow R\Gamma_{\mathrm{dR}^{\mathrm{an}}}(X).$$

3. *We have*

$$\begin{aligned} \mathrm{per} &= H^*(\phi_{\mathrm{sing}, \mathrm{dR}^{\mathrm{an}}})^{-1} \circ H^*(\phi_{\mathrm{dR}, \mathrm{dR}^{\mathrm{an}}}) : \\ & H_{\mathrm{dR}}^*(X) \otimes_k \mathbb{C} \rightarrow H_{\mathrm{sing}}^*(X^{\mathrm{an}}, \mathbb{Q}) \otimes_{\mathbb{Q}} \mathbb{C}. \end{aligned}$$

Proof. The first assertion follows by applying Lemma 1.4.10 to β and α . As before, we identify sheaves on $X \times_k \mathbb{C}$ with sheaves on the set of closed points of $X \times_k \mathbb{C}$. This yields a quasi-isomorphism

$$\alpha^{-1}\beta^{-1}Gd_X(\Omega_X^{\bullet}) \rightarrow Gd_{X^{\mathrm{an}}}(\alpha^{-1}\beta^{-1}\Omega_X^{\bullet}).$$

We compose with

$$Gd_{X^{\mathrm{an}}}(\alpha^{-1}\beta^{-1}\Omega_X^{\bullet}) \rightarrow Gd_{X^{\mathrm{an}}}(\Omega_{X^{\mathrm{an}}}^{\bullet}).$$

Taking global sections yields by definition a natural \mathbb{Q} -linear map of complexes

$$R\Gamma_{\mathrm{dR}}(X) \rightarrow R\Gamma_{\mathrm{dR}^{\mathrm{an}}}(X).$$

By extension of scalars we get $\phi_{\mathrm{dR}, \mathrm{dR}^{\mathrm{an}}}$. It is a quasi-isomorphism because on cohomology it defines the maps from Lemma 3.1.11 and Proposition 4.1.7.

The second assertion follows from ordinary functoriality of the Godement resolution. The last holds by construction. \square

In other words:

Corollary 5.5.2. *The assignment*

$$X \mapsto (R\Gamma_{\mathrm{dR}}(X), R\Gamma_{\mathrm{sing}}(X), R\Gamma_{\mathrm{dR}^{\mathrm{an}}}(X), \phi_{\mathrm{dR}, \mathrm{dR}^{\mathrm{an}}}, \phi_{\mathrm{sing}, \mathrm{dR}^{\mathrm{an}}})$$

defines a functor

$$R\Gamma : \mathrm{Sm} \rightarrow C_{(k, \mathbb{Q})}^+$$

where $C_{(k, \mathbb{Q})}^+$ is the category of cohomological (k, \mathbb{Q}) -Vect-complexes introduced in Definition 5.2.1.

Moreover,

$$H^*(R\Gamma(X)) = H(X),$$

where the functor H is defined as above.

Proof. Clear from the lemma. \square

By naturality, these definitions extend to objects in $\mathbb{Z}[\mathrm{Sm}]$.

Definition 5.5.3. Let

$$R\Gamma : K^-(\mathbb{Z}[\mathrm{Sm}]) \rightarrow D_{(k, \mathbb{Q})}^+$$

be defined (componentwise) as the total complex of the complex in $C_{(k, \mathbb{Q})}^+$ obtained by applying $R\Gamma$ in every degree. For $X_{\bullet} \in C^-(\mathbb{Z}[\mathrm{Sm}])$ and $i \in \mathbb{Z}$ we put

$$H^i(X_{\bullet}) = H^i R\Gamma(X_{\bullet}).$$

Definition 5.5.4. Let k be a subfield of \mathbb{C} and X a variety over k with a closed subvariety D . We define the *period isomorphism*

$$\mathrm{per} : H_{\mathrm{dR}}^*(X, D) \otimes_k \mathbb{C} \rightarrow H_{\mathrm{sing}}^*(X^{\mathrm{an}}, D^{\mathrm{an}}) \otimes_{\mathbb{Q}} \mathbb{C}$$

as follows: let $D_{\bullet} \rightarrow X_{\bullet}$ be smooth proper hypercovers of $D \rightarrow X$ as in Definition 3.3.6. Let

$$C_{\bullet} = \mathrm{Cone}(C(D_{\bullet}) \rightarrow C(X_{\bullet})) \in C^-(\mathbb{Z}[\mathrm{Sm}]).$$

Then $H^*(R\Gamma(C_{\bullet}))$ consists of

$$(H_{\mathrm{dR}}^*(X, D), H_{\mathrm{sing}}^*(X, D), \mathrm{per}).$$

In detail: per is given by the composition of the isomorphisms

$$H_{\mathrm{sing}}^*(X^{\mathrm{an}}, D^{\mathrm{an}}; \mathbb{Q}) \otimes_{\mathbb{Q}} \mathbb{C} \rightarrow H^*(R\Gamma_{\mathrm{sing}}(C_{\bullet}))$$

with

$$H^*(\phi_{\mathrm{sing}, \mathrm{dR}^{\mathrm{an}}}(C_{\bullet}))^{-1} \circ H^*(\phi_{\mathrm{dR}, \mathrm{dR}^{\mathrm{an}}}(C_{\bullet})).$$

We define the *period pairing*

$$\mathrm{per} : H_{\mathrm{dR}}^*(X, D) \times H_*^{\mathrm{sing}}(X^{\mathrm{an}}, D^{\mathrm{an}}) \rightarrow \mathbb{C}$$

to be the map

$$(\omega, \gamma) \mapsto \gamma(\mathrm{per}(\omega))$$

where we view classes in relative singular homology as linear forms on relative singular cohomology.

Lemma 5.5.5. *The map per is well-defined and compatible with products and long exact sequences for relative cohomology.*

Proof. By definition of relative algebraic de Rham cohomology (see Definition 3.3.6), the morphism takes values in $H_{\mathrm{dR}}^*(X, D) \otimes_k \mathbb{C}$. The first map is an isomorphism by proper descent in singular cohomology, see Theorem 2.7.6.

Compatibility with long exact sequences and multiplication comes from the definition. \square

We make this explicit in the case of a divisor with normal crossings. Recall the description of relative de Rham cohomology in this case in Proposition 3.3.19.

Theorem 5.5.6. *Let X be a smooth affine variety of dimension d and $D \subset X$ a divisor with simple normal crossings. Let $\omega \in \Omega_X^d(X)$ with associated cohomology class $[\omega] \in H_{\mathrm{dR}}^d(X, D)$. Let $c = \sum a_j \gamma_j$ be a singular homology class in $H_i^{\mathrm{sing}}(X^{\mathrm{an}}, D^{\mathrm{an}}, \mathbb{Q})$, where $a_j \in \mathbb{Q}$ and each $\gamma_j : \Delta_d \rightarrow X^{\mathrm{an}}$ is a differentiable singular cochain with boundary in D^{an} as in Definition 2.2.2. Then*

$$\mathrm{per}([\omega], c) = \sum a_j \int_{\Delta_i} \gamma_j^*(\omega).$$

Proof. Let D_{\bullet} be as in Section 3.3.4. We apply the considerations of the proof of Theorem 5.3.4 to X and the components of D_{\bullet} . Note that $\omega|_{D_I} = 0$ for dimension reasons. \square

Chapter 6

Categories of (mixed) motives

There are different candidates for the category of mixed or pure motives over a field k of characteristic zero. The category of Nori motives of Chapter 9 is one of them. We review some others.

6.1 Pure motives

The category of pure motives goes back to Grothendieck's approach to the Weil conjectures. His approach is based on algebraic cycles and intersection theory. The aim is to define an abelian category. As a first step, we introduce an additive pseudo-abelian candidate.

Recall that an additive category is called *pseudo-abelian* if every projector (a morphism p with $p^2 = p$) has kernel and image in the category. To every additive category, we can formally assign its *pseudo-abelian hull*, the so-called *Karoubian hull*. Its objects have the form (A, p) with $p : A \rightarrow A$ a projector with morphisms

$$\text{Mor}((A, p), (B, q)) = q\text{Mor}(A, B)p.$$

Definition 6.1.1. 1. The category of *effective integral Chow motives* CHM^{eff} is given by the pseudo-abelian hull of the following additive category:

- objects are given by smooth, projective varieties; where we write $[X]$ for the motive of X ;
- for smooth projective varieties X and Y , the morphisms from $[X]$ to $[Y]$ are given by the Chow group $\text{Ch}^{\dim X}(Y \times X)$ of algebraic cycles of codimension $\dim X$ up to rational equivalence;
- composition of morphisms is composition of correspondences: the composition of $\Gamma : X \rightarrow Y$ and $\Gamma' : Y \rightarrow Z$ is defined by push-forward of the intersection of $Z \times \Gamma$ and $\Gamma' \times X$ in $Z \times Y \times X$ to $Z \times X$:

$$\Gamma' \circ \Gamma = p_{ZX*}(p_{YX}^*\Gamma \cdot p_{ZY}^*\Gamma').$$

The identity morphism is given by the diagonal.

It becomes a tensor category with

$$[X] \otimes [Y] = [X \times Y]$$

for all smooth projective varieties. The category of *integral Chow motives* CHM is given by the localisation of the category of effective Chow motives with respect to the *Lefschetz motive* L which is the direct complement of $[\mathrm{Spec}(k)]$ in $[\mathbb{P}^1]$ with respect to a choice of k -rational point.

2. The category of *effective Chow motives* $\mathrm{CHM}_{\mathbb{Q}}^{\mathrm{eff}}$ is given by the same definition with rational Chow groups up to rational equivalence. The category of *Chow motives* $\mathrm{CHM}_{\mathbb{Q}}$ is given by its localisation with respect to the Lefschetz motive.
3. The category of *effective Grothendieck motives* $\mathrm{GRM}^{\mathrm{eff}}$ is given by the same definition but with the rational Chow group replaced by the group $A^{\dim X}(X \times X)$ of rational algebraic cycles of codimension $\dim X$ up to homological equivalence with respect to singular cohomology. The category of *Grothendieck motives* GRM is given by the localisation of the category of effective Grothendieck motives with respect to the Lefschetz motive L .

Remark 6.1.2. There is a *contravariant* functor $X \mapsto [X]$ from the category of smooth, projective varieties over k to Chow or Grothendieck motives. It maps a morphism $f : Y \rightarrow X$ to the transpose of its graph Γ_f . The dimension of Γ_f^t is the same as the dimension of Y , hence it has codimension $\dim X$ in $X \times Y$. On the other hand, singular cohomology defines a well-defined *covariant* functor on Chow and Grothendieck motives. Note that it is not a tensor functor due to the signs in the Künneth formula.

This normalisation is the original one, see e.g., [Man68]. In recent years, it has also become common to use the covariant normalisation instead, in particular in the case of Chow motives.

The category of Grothendieck motives is conjectured to be abelian and semi-simple. Jannsen has shown in [Jan92] that this is the case if and only if homological equivalence agrees with numerical equivalence.

The disadvantage of the above categories is their “wrong tensor structure”. This could be fixed by introducing signs — but only if the Künneth decomposition was known to be algebraic. André (see [And96], [And09, Section 9]) found a way of enlarging the category of Grothendieck unconditionally into an abelian semi-simple category and in a way that makes singular cohomology a tensor functor. We recall his construction:

Definition 6.1.3 ([And96, Définition 1]). Let k be subfield of \mathbb{C} . Let X be smooth projective variety over k . A *motivated cycle* on X of degree r is an element of $H^{2r}(X, \mathbb{Q})$ of the form $p_{X*}^{X \times Y}(\alpha \cdot *_L(\beta))$, where Y is a smooth projective variety, α and β are algebraic cycles on $X \times Y$ and $*_L$ is the inverse of the Lefschetz isomorphism attached to some polarisation of X and Y . Let $A_{\mathrm{mot}}^r(X)$ be the space of motivated cycles of degree r .

Lemma 6.1.4 ([And96, 2.1, 2.2]). *The space $A_{\text{mot}}^*(X)$ is a graded \mathbb{Q} -algebra containing algebraic cycles up to homological equivalence. It is stable under co- and contravariant functoriality for morphisms of smooth projective varieties.*

The algebra $A_{\text{mot}}^(X \times X)$ contains the Künneth projectors and the Lefschetz and Hodge involutions with respect to any polarisation of X .*

Definition 6.1.5. The categories AM^{eff} and AM of (effective) André motives are defined by substituting motivated cycles for algebraic cycles up to homological equivalence in Definition 6.1.1.

In Proposition 10.2.1, we are going to give an alternative characterisation of André motives.

Theorem 6.1.6 (André [And96, 4.4]). *The category AM is a semi-simple abelian rigid tensor category with fibre functor given by singular cohomology.*

6.2 Geometric motives

We recall the definition of geometrical motives first introduced by Voevodsky, see [VSF00, Chapter 5].

As before, let $k \subset \mathbb{C}$ be a field. It will be suppressed in the notation most of the time.

Definition 6.2.1 ([VSF00, Chapter 5, Section 2.1]). The category of *finite correspondences* SmCor_k has as objects smooth k -varieties. If X and Y are smooth varieties, then morphisms from X to Y in SmCor_k are given by the group of \mathbb{Z} -linear combinations of integral correspondences $\Gamma \subset X \times Y$ which are finite over X and dominant over a component of X .

Remark 6.2.2. The whole theory can also be developed with the group $\text{SmCor}_{\mathbb{Q}} = \text{SmCor} \otimes_{\mathbb{Z}} \mathbb{Q}$ of \mathbb{Q} -linear combinations of prime correspondences instead. Indeed, the same is true for any ring of coefficients.

The composition of $\Gamma : X \rightarrow Y$ and $\Gamma' : Y \rightarrow Z$ is defined by push-forward of the intersection of $\Gamma \times Z$ and $X \times \Gamma'$ in $X \times Y \times Z$ to $X \times Z$. The identity morphism is given by the diagonal. There is a natural covariant functor

$$\text{Sm}_k \rightarrow \text{SmCor}_k$$

which maps a smooth variety to itself and a morphism to its graph.

The category SmCor_k is additive, hence we can consider its homotopy category $K^b(\text{SmCor}_k)$. The latter is triangulated.

Definition 6.2.3 ([VSF00, Chapter 5, Definition 2.1.1]). The category of *effective geometrical motives* $DM_{\text{gm}}^{\text{eff}} = DM_{\text{gm}}^{\text{eff}}(k, \mathbb{Z})$ is the pseudo-abelian

hull of the localisation of $K^b(\text{SmCor}_k)$ with respect to the thick subcategory generated by objects of the form

$$[X \times \mathbb{A}^1 \xrightarrow{\text{pr}} X]$$

for all smooth varieties X and

$$[U \cap V \rightarrow U \amalg V \rightarrow X]$$

for all open covers $U \cup V = X$ of all smooth varieties X .

Remark 6.2.4. We think of $DM_{\text{gm}}^{\text{eff}}$ as the bounded derived category of the conjectural abelian category of effective mixed motives.

We denote by

$$M : \text{SmCor}_k \rightarrow DM_{\text{gm}}^{\text{eff}}$$

the functor which views a variety as a complex concentrated in degree 0. By [VSF00, Chapter 5, Section 2.2], it extends (non-trivially!) to a functor on the category of all k -varieties.

The category $DM_{\text{gm}}^{\text{eff}}$ is tensor triangulated such that

$$M(X) \otimes M(Y) = M(X \times Y)$$

for all smooth varieties X and Y . The unit of the tensor structure is given by

$$\mathbb{Z}(0) = M(\text{Spec}(k)).$$

The *Tate motive* $\mathbb{Z}(1)$ is defined by the equation

$$M(\mathbb{P}^1) = \mathbb{Z}(0) \oplus \mathbb{Z}(1)[2].$$

We write $M(n) = M \otimes \mathbb{Z}(1)^{\otimes n}$ for $n \geq 0$. By [VSF00, Chapter 5, Section 2.2], the functor

$$(n) : DM_{\text{gm}}^{\text{eff}} \rightarrow DM_{\text{gm}}^{\text{eff}}$$

is fully faithful.

Definition 6.2.5. The category of *geometric motives* DM_{gm} is the stabilisation of $DM_{\text{gm}}^{\text{eff}}$ with respect to $\mathbb{Z}(1)$. Objects are of the form $M(n)$ for $n \in \mathbb{Z}$ and morphisms are given by

$$\text{Hom}_{DM_{\text{gm}}}(M(n), M'(n')) = \text{Hom}_{DM_{\text{gm}}^{\text{eff}}}(M(n+N), M'(n'+N)) \quad N \gg 0.$$

Remark 6.2.6. We think of DM_{gm} as the bounded derived category of the conjectural abelian category of mixed motives.

The category DM_{gm} is rigid by [VSF00, Chapter 5, Section 2.2], i.e., every object M has a strong dual M^\vee such that there are natural isomorphisms

$$\begin{aligned} \mathrm{Hom}_{DM_{\mathrm{gm}}}(A \otimes B, C) &\cong \mathrm{Hom}_{DM_{\mathrm{gm}}}(A, B^\vee \otimes C) \\ A^\vee \otimes B^\vee &\cong (A \otimes B)^\vee \\ (A^\vee)^\vee &\cong A \end{aligned}$$

for all objects A, B, C .

Remark 6.2.7. Rigidity is a deep result. It depends on a moving lemma for cycles and computations in Voevodsky's category of motivic complexes.

Example 6.2.8. If X is smooth and projective of pure dimension d , then

$$M(X)^\vee = M(X)(-d)[-2d].$$

For completeness, we record the relation to higher Chow groups and algebraic K -theory.

Definition 6.2.9. Let k be a field of characteristic 0. Let X be a variety over k . We put

$$H_{\mathcal{M}}^p(X, \mathbb{Z}(q)) = \mathrm{Hom}_{DM_{\mathrm{gm}}}(M(X), \mathbb{Z}(q)[p]),$$

the *motivic cohomology* of X in degree p with twist q .

Theorem 6.2.10. *If X is smooth, then motivic cohomology agrees with Bloch's higher Chow groups (see [Blo86])*

$$H_{\mathcal{M}}^p(X, \mathbb{Z}(q)) = \mathrm{Ch}^q(X, 2q - p)$$

and, after tensoring with \mathbb{Q} , with Adams eigenspaces of algebraic K -theory

$$H_{\mathcal{M}}^p(X, \mathbb{Q}(q)) = K_{2q-p}(X)_{\mathbb{Q}}^{(q)}.$$

Proof. The first identification is [MVW06, Theorem 19.1]. The second is a consequence of the first by [Blo86, Theorem 9.1], complemented by [Blo94]. It was also shown in [Lev94, Theorem 3.4]. \square

In the special case $q = 2p$ this is, in particular, a result on ordinary Chow groups. This implies:

Theorem 6.2.11 ([VSF00, Chapter 5, Proposition 2.1.4]). *The functor $X \mapsto M(X)$ on smooth projective varieties extends to a natural contravariant fully faithful tensor functor*

$$\mathrm{CHM} \rightarrow DM_{\mathrm{gm}}.$$

In our normalisation (with Chow motives contravariant and geometric motives covariant on varieties), this functor maps the Lefschetz motive L to the Tate motive $\mathbb{Z}(1)[2]$.

Gillet and Soulé in [GS96] explained how to associate to a variety a bounded complex of Chow motives. In a series of papers, Bondarko put this

construction into an abstract framework and generalised it to all geometric motives. We summarise some of his results that we are going to apply.

Theorem 6.2.12 (Bondarko [Bon10, Section 6]). *Let k be a field of characteristic 0. The category DM_{gm} of geometric motives carries a non-degenerate bounded weight structure with heart given by CHM^{op} , i.e., there are classes $DM_{\text{gm}}^{w \leq 0}$ and $DM_{\text{gm}}^{w \geq 0}$ of objects of DM_{gm} satisfying:*

1. both are additive and closed under direct summands;
2. $DM_{\text{gm}}^{w \geq 0} \subset DM_{\text{gm}}^{w \geq 0}[1]$, $DM_{\text{gm}}^{w \leq 0}[1] \subset DM_{\text{gm}}^{w \leq 0}$;
3. For $M \in DM_{\text{gm}}^{w \geq 0}$ and $N \in DM_{\text{gm}}^{w \leq 0}[1]$, we have $\text{Hom}_{DM_{\text{gm}}}(M, N) = 0$;
4. For any $M \in DM_{\text{gm}}$, there are $A \in DM_{\text{gm}}^{w \leq 0}$ and $B \in DM_{\text{gm}}^{w \geq 0}$ and an exact triangle

$$A[-1] \rightarrow M \rightarrow B;$$

5. $\bigcap_{i \in \mathbb{Z}} DM_{\text{gm}}^{w \leq 0}[-i] = \bigcap_{i \in \mathbb{Z}} DM_{\text{gm}}^{w \geq 0}[-i] = 0$;
6. $\bigcup_{i \in \mathbb{Z}} DM_{\text{gm}}^{w \leq 0}[-i] = \bigcup_{i \in \mathbb{Z}} DM_{\text{gm}}^{w \geq 0}[-i] = \text{Ob}(DM_{\text{gm}})$;
7. $DM_{\text{gm}}^{w \leq 0} \cap DM_{\text{gm}}^{w \geq 0} = \text{Ob}(\text{CHM}^{op})$.

We write

$$DM_{\text{gm}}^{w \geq i} = DM^{w \geq 0}[-i], DM_{\text{gm}}^{w \leq i} = DM^{w \leq 0}[-i].$$

From the axioms, we immediately see that for every $M \in DM_{\text{gm}}$ there is an exact triangle

$$A \rightarrow M \rightarrow B$$

with $A \in DM_{\text{gm}}^{w \leq i}$, $B \in DM_{\text{gm}}^{w \geq i+1}$. We write $A = w_{\leq i}M$ and $B = w_{\geq i+1}M$. Note that they are *not* functors.

Remark 6.2.13. The above follows the original normalisation of Bondarko in [Bon10]. There are other references where the roles of $DM_{\text{gm}}^{w \leq 0}$ and $DM_{\text{gm}}^{w \geq 0}$ are switched.

Bondarko shows that this weight structure induces a weight filtration under any cohomological functor. More precisely:

Proposition 6.2.14 (Bondarko [Bon10, Section 2]). *Let \mathcal{A} be an abelian category and $H : DM_{\text{gm}} \rightarrow \mathcal{A}$ be a contravariant cohomological functor, i.e., it is additive and maps exact triangles to exact sequences. For $M \in DM_{\text{gm}}$ we put*

$$W_i H(M) = \text{Im}(H(w_{\geq i}M) \rightarrow H(M)).$$

Then $M \mapsto W_i H(M)$ is a well-defined subfunctor of H . Moreover, we have natural transformations of subfunctors

$$W_{i-1}H \rightarrow W_i H$$

and for all $M \in DM_{\text{gm}}$, the quotient $W_i H(M)/W_{i-1} H(M)$ is isomorphic to an object of the form

$$\text{Ker}(H(P[-i]) \rightarrow H(P'[-i]))$$

for some morphism $P' \rightarrow P$ in CHM^{op} .

Proof. Consider the weight decompositions

$$w_{\leq n} M \rightarrow M \rightarrow w_{\geq n+1} M$$

for $n = i - 1, i$. By [Bon10, Proposition 1.5.6], there is a unique morphism

$$q : w_{\geq i} M \rightarrow w_{\geq i-1} M$$

compatible with the morphisms to M . This implies that $W_{i-1} H(M) \subset W_i H(M)$. Moreover, there is an exact triangle

$$P([-i]) \rightarrow w_{\geq i} M \xrightarrow{q} w_{\geq i-1} M$$

with $P \in \text{CHM}^{op}$. Applying H , this implies that

$$H(w_{\geq i-1} M) \rightarrow H(w_{\geq i} M) \rightarrow H(P[-i]) \rightarrow H(w_{\geq i-1} M[1])$$

is exact. We view $w_{\geq i-1} M[1]$ as $w_{\geq i}(M[1])$. Again by [Bon10, Proposition 1.5.6], there is an exact triangle

$$P'[-i] \rightarrow w_{\geq i}(M[1]) \rightarrow w_{\geq i-1}(M[1])$$

for a Chow motive P' . Hence we have an exact sequence

$$\begin{aligned} \text{Hom}_{DM_{\text{gm}}}(P[-i], P'[-i]) &\rightarrow \text{Hom}_{DM_{\text{gm}}}(P[-i], w_{\geq i}(M[1])) \\ &\rightarrow \text{Hom}_{DM_{\text{gm}}}(P[-i], w_{\geq i-1}(M[1])). \end{aligned}$$

The group on the right vanishes by Property 2. of Theorem 6.2.12. Hence our connecting morphism lifts to an element of

$$\text{Hom}_{DM_{\text{gm}}}(P[-i], P'[-i]) = \text{Hom}_{\text{CHM}^{op}}(P, P').$$

□

6.3 Absolute Hodge motives

The notion of absolute Hodge motives was introduced by Deligne, see [DMOS82, Chapter II] in the pure case, and independently by Jannsen, cf.

[Jan90]. We follow the presentation of Jannsen, also used in our own extension to the triangulated setting, cf. [Hub95]. We give a rough overview of the construction and refer to the literature for full details.

We fix a subfield $k \subset \mathbb{C}$ and an algebraic closure \bar{k}/k . Let $G_k = \text{Gal}(\bar{k}/k)$. Let S be the set of embeddings $\sigma : k \rightarrow \mathbb{C}$ and \bar{S} the set of embeddings $\bar{\sigma} : \bar{k} \rightarrow \mathbb{C}$. Restriction of fields induces a map $\bar{S} \rightarrow S$.

Definition 6.3.1 ([Hub95, Definition 11.1.1]). Let $\mathcal{MR} = \mathcal{MR}(k)$ be the additive category of *mixed realisations* with objects given by the following data:

- a bifiltered k -vector space A_{dR} ;
- for each prime l , a filtered \mathbb{Q}_l -vector space A_l with a continuous operation of G_k ;
- for each prime l and each $\sigma \in S$, a filtered \mathbb{Q}_l -vector space $A_{\sigma,l}$;
- for each $\sigma \in S$, a filtered \mathbb{Q} -vector space A_σ ;
- for each $\sigma \in S$, a filtered \mathbb{C} -vector space $A_{\sigma,\mathbb{C}}$;
- for each $\sigma \in S$, a filtered isomorphism

$$I_{\text{dR},\sigma} : A_{\text{dR}} \otimes_\sigma \mathbb{C} \rightarrow A_{\sigma,\mathbb{C}};$$

- for each $\sigma \in S$, a filtered isomorphism

$$I_{\sigma,\mathbb{C}} : A_\sigma \otimes_{\mathbb{Q}} \mathbb{C} \rightarrow A_{\sigma,\mathbb{C}};$$

- for each $\sigma \in S$ and each prime l , a filtered isomorphism

$$I_{\bar{\sigma},l} : A_\sigma \otimes_{\mathbb{Q}} \mathbb{Q}_l \rightarrow A_{\sigma,l};$$

- for each prime l and each $\sigma \in S$, a filtered isomorphism

$$I_{l,\sigma} : A_l \otimes_{\mathbb{Q}} \mathbb{Q}_l \rightarrow A_{\sigma,l}.$$

These data are subject to the following conditions:

- For each σ , the tuple $(A_\sigma, A_{\sigma,\mathbb{C}}, I_{\sigma,\mathbb{C}})$ is a mixed Hodge structure;
- For each l , the filtration on A_l is the *filtration by weights*: its graded pieces $\text{gr}_n^W A_l$ extend to a model of finite type over \mathbb{Z} which is pointwise pure of weight n in the sense of Deligne, i.e., for each closed point with residue field κ , the Frobenius operator has eigenvalues $N(\kappa)^{n/2}$.

Morphisms of mixed realisations are morphisms of these data compatible with all filtrations and comparison isomorphisms.

The above has already used the notion of a Hodge structure, as introduced by Deligne.

Definition 6.3.2 (Deligne [Del71]). A *mixed Hodge structure* consists of the following data:

- a finite-dimensional filtered \mathbb{Q} -vector space $(V_{\mathbb{Q}}, W_*)$;
- a finite-dimensional bifiltered \mathbb{C} -vector space $(V_{\mathbb{C}}, W_*, F^*)$;
- a filtered isomorphism $I_{\mathbb{C}} : (V_{\mathbb{Q}}, W_*) \otimes \mathbb{C} \rightarrow (V_{\mathbb{C}}, W_*)$

such that for all $n \in \mathbb{Z}$ the induced triple $(\mathrm{gr}_n^W V_{\mathbb{Q}}, \mathrm{gr}_n^W V_{\mathbb{C}}, \mathrm{gr}_n^W I)$ satisfies

$$\mathrm{gr}_n^W V_{\mathbb{C}} = \bigoplus_{p+q=n} F^p \mathrm{gr}_n^W V_{\mathbb{C}} \oplus \overline{F^q \mathrm{gr}_n^W V_{\mathbb{C}}}$$

with complex conjugation taken with respect to the \mathbb{R} -structure defined by $\mathrm{gr}_n^W V_{\mathbb{Q}} \otimes_{\mathbb{Q}} \mathbb{R}$.

A Hodge structure is called *pure of weight n* if W_* is concentrated in degree n . It is called *pure* if it is a direct sum of pure Hodge structures of different weights.

A morphism of Hodge structures is given by morphisms of these data compatible with both filtrations and the comparison isomorphism.

By [Del71], this is an abelian category. All morphisms of Hodge structures are automatically strictly compatible with filtrations. This immediately implies:

Proposition 6.3.3 ([Hub95, Lemma 11.1.2]). *The category \mathcal{MR} is abelian. Kernels and cokernels are computed componentwise. Every object A has a canonical weight filtration $W_i A$ such that $\mathrm{gr}_i^W A$ is pure of weight i . All morphisms are strict with respect to the weight filtration.*

Remark 6.3.4. We recall the abelian category $(k, \mathbb{Q})\text{-Vect}$ from Definition 5.1.1. Fix $\iota : k \rightarrow \mathbb{C}$. Then the projection

$$A \mapsto (A_{\mathrm{dR}}, A_{\iota}, I_{\iota, \mathbb{C}}^{-1} I_{\mathrm{dR}, \iota})$$

obviously defines a faithful functor

$$\mathcal{MR} \rightarrow (k, \mathbb{Q})\text{-Vect}.$$

This functor will become important in connection with periods of motives, see Section 11.5.

The notation in Definition 6.3.1 is suggestive. If X is a smooth variety, then there is a natural mixed realisation $H = H_{\mathcal{MR}}^*(X)$ where

- $H_{\mathrm{dR}} = H_{\mathrm{dR}}^*(X)$ is algebraic de Rham cohomology as in Chapter 3, Section 3.1;
- $H_l = H^*(X_{\bar{k}}, \mathbb{Q}_l)$ is l -adic cohomology with its natural Galois operation;
- $H_{\sigma} = H^*(X \times_{\sigma} \mathrm{Spec}(\mathbb{C}), \mathbb{Q})$ is singular cohomology;
- $H_{\sigma, \mathbb{C}} = H_{\sigma} \otimes \mathbb{C}$ and $H_{\sigma, l} = H_{\sigma} \otimes \mathbb{Q}_l$;
- $I_{\mathrm{dR}, \sigma}$ is the period isomorphism of Definition 5.3.1 ;
- $I_{l, \sigma}$ is induced by the comparison isomorphism between l -adic and singular cohomology over \mathbb{C} .

Proposition 6.3.5 ([Hub95, Lemma 11.2.1]). *Let X be a variety, then the above tuple defines an object $H_{\mathcal{MR}}^*(X)$. If X is smooth projective, then $H_{\mathcal{MR}}^i(X)$ is pure of weight i .*

This is actually a summary of some of the deepest results in arithmetic geometry due to Deligne, see [Del71], [Del74b], [Del74a], [Del80].

Remark 6.3.6. If we assume the Hodge or the Tate conjecture, then the functor $H_{\mathcal{MR}}^*$ is fully faithful on the category of Grothendieck motives (with homological or, under these assumptions equivalently, numerical equivalence). Hence it gives a linear algebra description of the conjectural abelian category of pure motives.

Jannsen in [Jan90, Theorem 6.11.1] extends the definition to singular varieties. A refined version of his construction is given in [Hub95]. We sum up its properties.

Definition 6.3.7 ([Hub00, Definition 2.2.2]). Let C^+ be the category with objects given by a tuple of complexes in the additive categories in Definition 6.3.1 with filtered quasi-isomorphisms between them. The category of *mixed realisation complexes* $C_{\mathcal{MR}}$ is the full subcategory of complexes with strict differentials and cohomology objects in \mathcal{MR} . Let $D_{\mathcal{MR}}$ be the localisation of the homotopy category of $C_{\mathcal{MR}}$ (see [Hub95]) with respect to quasi-isomorphisms (see [Hub95, Definition 4.1.7]).

By construction, there are natural cohomology functors:

$$H^i : C_{\mathcal{MR}} \rightarrow \mathcal{MR}$$

factoring over $D_{\mathcal{MR}}$.

Remark 6.3.8. One should think of $D_{\mathcal{MR}}$ as the derived category of \mathcal{MR} , even though this is false in a literal sense.

The main construction of [Hub95] is a functor from varieties to mixed realisations.

Theorem 6.3.9 ([Hub95, Section 11.2], [Hub00, Theorem 2.3.1]). *Let Sm_k be the category of smooth varieties over k . There is a natural additive functor*

$$\tilde{R}_{\mathcal{MR}} : \mathrm{Sm}_k \rightarrow C_{\mathcal{MR}},$$

such that

$$H_{\mathcal{MR}}^i(X) = H^i(\tilde{R}_{\mathcal{MR}}(X)).$$

This allows us to extend \tilde{R} to the additive category $\mathbb{Q}[\mathrm{Sm}_k]$ and even to the category of complexes $C^-(\mathbb{Q}[\mathrm{Sm}_k])$.

Remark 6.3.10. There is a subtle technical point here. The category C^+ is additive. Taking the total complex of a complex in C^+ gives again an object of C^+ . It is a non-trivial statement that the subcategory $C_{\mathcal{MR}}$ is respected, see [Hub00, Lemma 2.2.5].

Following Deligne and Jannsen, we can now define:

Definition 6.3.11. An object $M \in \mathcal{MR}$ is called an *effective absolute Hodge motive* if it is a subquotient of an object in the image of

$$H^* \circ \tilde{R} : C^b(\mathbb{Q}[\mathrm{Sm}_k]) \rightarrow \mathcal{MR}.$$

Let $\mathcal{MM}_{\mathrm{AH}}^{\mathrm{eff}} = \mathcal{MM}_{\mathrm{AH}}^{\mathrm{eff}}(k) \subset \mathcal{MR}$ be the category of all effective absolute Hodge motives over k . Let $\mathcal{MM}_{\mathrm{AH}} = \mathcal{MM}_{\mathrm{AH}}(k) \subset \mathcal{MR}$ be the full abelian tensor subcategory generated by $\mathcal{MM}_{\mathrm{AH}}^{\mathrm{eff}}$ and the dual of $\mathbb{Q}(-1) = H_{\mathcal{MR}}^2(\mathbb{P}^1)$. Objects in $\mathcal{MM}_{\mathrm{AH}}$ are called *absolute Hodge motives over k* .

Remark 6.3.12. The rationale behind this definition lies in Remark 6.3.6. Every mixed motive is supposed to be an iterated extension of pure motives. The latter are conjecturally fully described by their mixed realisation. Hence, it remains to specify which extensions of pure motives are mixed motives.

Jannsen (see [Jan90, Definition 4.1]) does not use complexes of varieties but only single smooth varieties. It is not clear whether the two definitions agree, see also the discussion in [Hub95, Section 22.3]. On the other hand, in [Hub95, Definition 22.13] the varieties were allowed to be singular. This is equivalent to the above by the construction in [Hub04, Lemma B.5.3] where every complex of varieties is replaced by a complex of smooth varieties with the same cohomology.

Recall again the abelian category $(k, \mathbb{Q})\text{-Vect}$ from Definition 5.1.1. Recall also the triangulated category $D_{(k, \mathbb{Q})}^+$ from Definition 5.2.1.

Fix $\iota : k \rightarrow \mathbb{C}$. The projection

$$K \mapsto (K_{\mathrm{dR}}, K_{\iota}, K_{\iota, \mathbb{C}}, I_{\mathrm{dR}, \iota}, I_{\iota, \mathbb{C}})$$

defines a functor

$$C_{\mathcal{MR}} \rightarrow C_{(k, \mathbb{Q})}^+$$

which induces a triangulated functor

$$\mathrm{forget} : D_{\mathcal{MR}} \rightarrow D_{(k, \mathbb{Q})}^+$$

compatible with the forgetful functor $\mathcal{MR} \rightarrow (k, \mathbb{Q})\text{-Vect}$ of Remark 6.3.4.

Lemma 6.3.13. *There is a natural transformation of functors*

$$K^-(\mathbb{Z}[\mathrm{Sm}_k]) \rightarrow D_{(k, \mathbb{Q})}^+$$

between $\mathrm{forget} \circ R_{\mathcal{MR}}$ and $R\Gamma$.

Proof. This is true by construction of the dR- and σ -components of $R_{\mathcal{MR}}$ in [Hub95]. In fact, the definition of $R\Gamma$ is a simplified version of the construction given there. \square

Remark 6.3.14. The construction of $R\Gamma$ is *not* identical to the one given in [Hub95], because \mathcal{MR} takes the Hodge and weight filtration into account.

We finish our discussion of various categories of motives, by making the connection between geometric and absolute Hodge motives.

Theorem 6.3.15 ([Hub00], [Hub04]). *Let k be a field embeddable into \mathbb{C} . Then there is tensor triangulated functor*

$$R_{\mathcal{MR}} : DM_{\text{gm}} \rightarrow D_{\mathcal{MR}}$$

compatible with the functor $\tilde{R}_{\mathcal{MR}}$ of Theorem 6.3.9 on $\mathbb{Z}[\text{Sm}]$. For all $M \in DM_{\text{gm}}$, the objects $H^i R_{\mathcal{MR}}(M)$ are absolute Hodge motives.

Proof. This is the main result of [Hub00]. Note that there is a Corrigendum [Hub04]. The second assertion is [Hub00, Theorem 2.3.6]. \square

We can now consider the cohomological functor

$$H_{\mathcal{MR}}^0 = H^0 \circ R_{\mathcal{MR}} : DM_{\text{gm}} \rightarrow \mathcal{MR},$$

and Bondarko's weight filtration $W_i H_{\mathcal{MR}}^0$ (see Proposition 6.2.14). On the other hand, we have weight filtration functors

$$W_i : \mathcal{MR} \rightarrow \mathcal{MR}.$$

Corollary 6.3.16. *For all $i \in \mathbb{Z}$, the subfunctor $W_i H_{\mathcal{MR}}^0$ is canonically isomorphic to $W_i \circ H_{\mathcal{MR}}^0$.*

Proof. It suffices to show that for every $M \in DM_{\text{gm}}$, the quotient

$$W_i H_{\mathcal{MR}}^0(M) / W_{i-1} H_{\mathcal{MR}}^0(M)$$

is pure of weight i in the sense of mixed realisations. By Proposition 6.2.14, the quotient is of the form $H_{\mathcal{MR}}^0(P[-i])$ for $P \in \text{CHM}$. Hence

$$H^0 \circ R_{\mathcal{MR}}(P[-i]) = H^0 \circ (R_{\mathcal{MR}}(P)[i]) = H_{\mathcal{MR}}^i(P)$$

is pure of weight i by Proposition 6.3.5. \square

6.4 Mixed Tate motives

In this section, let k be a number field. We work with rational coefficients. Our aim is to discuss the subcategory generated by Tate motives $\mathbb{Q}(i)$ for all $i \in \mathbb{Z}$. The restriction is needed because the Beilinson–Soulé vanishing conjecture is available only in this case.

Theorem 6.4.1 (Borel). *Let k be a number field, $i, j, n, m \in \mathbb{Z}$. Then*

$$\mathrm{Hom}_{DM_{\mathrm{gm},\mathbb{Q}}}(\mathbb{Q}(i)[n], \mathbb{Q}(j)[m]) = 0,$$

if one of the following conditions is satisfied:

1. $m < n$, or
2. $m > n + 1$, or
3. $m = n$ and $i \neq j$, or
4. $m = n + 1$ and $i \geq j$, or
5. $i < j$.

Moreover, the mixed realisation functor

$$\mathrm{Hom}_{DM_{\mathrm{gm},\mathbb{Q}}}(\mathbb{Q}, \mathbb{Q}(j)[1]) \rightarrow \mathrm{Ext}_{\mathcal{MR}}^1(\mathbb{Q}, \mathbb{Q}(j))$$

is injective.

Proof. It suffices to consider $i = n = 0$. The key input is Borel's computation of algebraic K -groups in [Bor74]. He established for $n > 1$ an isomorphism (the *Borel regulator*)

$$K_n(k)_{\mathbb{R}} \cong K_n(\mathcal{O}_k)_{\mathbb{R}} \rightarrow \mathbb{R}^{d_n}$$

into a suitable \mathbb{R} -vector space with explicitly described dimension d_n . By [BG02], the Borel regulator can be identified up to a factor of 2 with the *Beilinson regulator*, i.e., the Chern class into Deligne or absolute Hodge cohomology

$$K_n(k)_{\mathbb{R}} \rightarrow H_{\mathcal{D}}^1(\mathrm{Spec}(k) \otimes_{\mathbb{Q}} \mathbb{R}, \mathbb{R}(j))$$

with $n = 2j - 1$. In particular, it factors via the j -th Adams eigenspace $K_{2j-1}(k)_{\mathbb{Q}}^{(j)}$ and all other eigenspaces vanish. By [VSF00, Chapter V, §2.2, p. 197], morphisms of geometric motives can be computed by higher Chow groups, which in turn are given by algebraic K -groups:

$$\mathrm{Hom}_{DM_{\mathrm{gm},\mathbb{Q}}}(\mathbb{Q}, \mathbb{Q}(j)[m]) = \mathrm{Ch}^j(\mathrm{Spec}(k), 2j - m)_{\mathbb{Q}} \cong K_{2j-m}(\mathrm{Spec}(k))_{\mathbb{Q}}^{(j)}.$$

Together this gives the vanishing statements for $2j - m \neq 0, 1$. The remaining exceptional cases are easier:

$$\begin{aligned} K_0(\mathrm{Spec}(k))_{\mathbb{Q}} &= K_0(\mathrm{Spec}(k))_{\mathbb{Q}}^{(0)} = \mathbb{Q}, \\ K_1(\mathrm{Spec}(k))_{\mathbb{Q}} &= K_1(\mathrm{Spec}(k))_{\mathbb{Q}}^{(1)} = k^{\times} \otimes \mathbb{Q}. \end{aligned}$$

For injectivity on Ext^1 , we claim that the Chern class factors as

$$K_{2j-1}(\mathrm{Spec}(k))_{\mathbb{Q}} \rightarrow \mathrm{Ext}_{\mathcal{MR}}^1(\mathbb{Q}, \mathbb{Q}(j)) \rightarrow H_{\mathcal{D}}^1(\mathrm{Spec}(k) \otimes_{\mathbb{Q}} \mathbb{R}, \mathbb{R}(j)).$$

By [Beř86], Deligne cohomology can be identified with absolute Hodge cohomology. In our case this is

$$\begin{aligned} H_{\mathcal{D}}^1(\mathrm{Spec}(k) \otimes_{\mathbb{Q}} \mathbb{C}, \mathbb{R}(j)) &= \mathrm{Ext}_{\mathrm{MHS}}^1(H^0(\mathrm{Spec}(k) \otimes_{\mathbb{Q}} \mathbb{C}, \mathbb{R}), \mathbb{R}(j)) \\ &= \bigoplus_{\sigma: k \rightarrow \mathbb{C}} \mathrm{Ext}_{\mathrm{MHS}}^1(\mathbb{R}, \mathbb{R}(j)), \end{aligned}$$

where MHS is the abelian category of \mathbb{R} -Hodge structures. For every σ , there is a forgetful functor from \mathcal{MR} to MHS. The factorisation follows from the naturality of the Chern class maps. Hence the injectivity follows from the injectivity of the Borel regulator. In the missing case $j = 1$, we proceed as in the proof of [DG05, Propostion 2.14]. Pick $\sigma : k \rightarrow \mathbb{C}$. The Chern class into $\mathrm{Ext}_{\mathrm{MHS}}^1(\mathbb{Q}, \mathbb{Q}(1))$ has an explicit description as

$$k^{\times} \otimes_{\mathbb{Z}} \mathbb{Q} \rightarrow \mathbb{C}/2\pi i\mathbb{Q}, x \mapsto \log(\sigma(x))$$

for any choice of branch of log. It is injective. \square

We want to think of $\mathbb{Q}(i)$ as a complex concentrated in degree 0 and hence $\mathbb{Q}(i)[n]$ as a complex concentrated in degree $-n$.

Definition 6.4.2. 1. Let k be a number field. We define the *triangulated category of mixed Tate motives* DTM as the full triangulated subcategory of $DM_{\mathrm{gm}, \mathbb{Q}}$ closed under direct summands and containing all $\mathbb{Q}(i)$ for $i \in \mathbb{Z}$.
2. Let $DTM^{\leq 0}$ be the full subcategory of objects X such that

$$\mathrm{Hom}_{DTM}(X, \mathbb{Q}(j)[m]) = 0 \text{ for all } j \in \mathbb{Z}, m < 0.$$

3. Let $DTM^{\geq 0}$ be the full subcategory of objects Y such that

$$\mathrm{Hom}_{DTM}(\mathbb{Q}(i)[n], Y) = 0 \text{ for all } i \in \mathbb{Z}, n > 0.$$

4. Let

$$\mathcal{MTM}_{\mathrm{gm}} = DTM^{\geq 0} \cap DTM^{\leq 0}$$

be the category of *mixed Tate motives over k* .

From the vanishing conjecture, one deduces quite formally the existence of an *abelian* category of mixed Tate motives. Recall from Theorem 2.5.18 that we get an abelian category from a t -structure, see Definition 2.5.15.

Proposition 6.4.3 (Levine [Lev93, Theorem 4.2, Corollary 4.3]). *Let k be a number field. Then $(DTM^{\leq 0}, DTM^{\geq 0})$ is a t -struture on DTM . In particular, the category $\mathcal{MTM}_{\mathrm{gm}}$ is abelian. It contains all $\mathbb{Q}(i)$ for $i \in \mathbb{Z}$. Moreover, the category has cohomological dimension one and the Ext-groups are computed in DM_{gm} , i.e.,*

$$\mathrm{Ext}_{\mathcal{MTM}_{\mathrm{gm}}}^n(X, Y) = \mathrm{Hom}_{DM_{\mathrm{gm}}}(X, Y[n]),$$

and the group vanishes for $n \neq 0, 1$.

There are canonical exact subfunctors $\nu^{\geq i} : \mathcal{MTM}_{\text{gm}} \rightarrow \mathcal{MTM}_{\text{gm}}$ of the identity with $\nu^{\geq i} \rightarrow \nu^{\geq i-1}$ such that for every $M \in \mathcal{MTM}_{\text{gm}}$ the graded quotients $\text{gr}_i^\nu M$ are of the form $\bigoplus_{n \in I} \mathbb{Q}(i)$ for a finite index set I .

Remark 6.4.4. The letter $\nu^{\geq i}$ stands for the slice filtration on motivic complexes. It restricts to the above filtration on mixed Tate motives, see [HK06, Section 4].

Proposition 6.4.5 ([DG05]). *Let k be a number field. Then the functor $H_{\mathcal{MR}}^0 : \mathcal{MTM}_{\text{gm}} \rightarrow \mathcal{MM}_{\text{AH}}$ is exact. It is fully faithful and the image is closed under subquotients.*

We write $M_{\mathcal{MR}} := H_{\mathcal{MR}}^0(M)$ for $M \in \mathcal{MTM}_{\text{gm}}$.

Proof. We argue by the length of the weight filtration $\nu^{\geq i}$ in order to show that for all $M, N \in \mathcal{MTM}_{\text{gm}}$:

$$\begin{aligned} \text{Hom}_{\mathcal{MTM}_{\text{gm}}}(M, N) &\cong \text{Hom}_{\mathcal{MR}}(M_{\mathcal{MR}}, N_{\mathcal{MR}}), \\ \text{Ext}_{\mathcal{MTM}_{\text{gm}}}^1(M, N) &\subset \text{Ext}_{\mathcal{MR}}^1(M_{\mathcal{MR}}, N_{\mathcal{MR}}). \end{aligned}$$

The first statement is true for pure Tate motives of fixed weight, because the category is equivalent to the category of finite-dimensional \mathbb{Q} -vector spaces. The same is true for the mixed realisation. The second statement is essentially due to Borel, see Theorem 6.4.1. The inductive step is a simple diagram chase. The same induction also shows that $H_{\mathcal{MR}}^0$ is exact. The statement on subquotients is true for pure Tate motives, because the category is semi-simple. By induction on the weight filtration, it follows in general. \square

In the context of the conjectures on special values of L -functions (see Section 16.1) or multiple zeta values (see Chapter 15), we actually need a smaller category. Before going into the definition, let us first explain the problem. Any element of

$$k^\times \otimes_{\mathbb{Z}} \mathbb{Q} = K_1(k)_{\mathbb{Q}} = \text{Hom}_{DM_{\text{gm}}}(\mathbb{Q}, \mathbb{Q}(1)[1])$$

gives rise to an element of $\text{Ext}_{\mathcal{MTM}_{\text{gm}}}^1(\mathbb{Q}, \mathbb{Q}(1))$. Hence this is an infinite-dimensional vector space. The elements of number-theoretic significance are those coming from the units of the ring of integers, a finite-dimensional \mathbb{Q} -subspace. Actually, this particular Ext-group is the only problematic one. For all other twists, all extensions over k already come from extensions over \mathcal{O}_k .

Definition 6.4.6 (Deligne–Goncharov [DG05, Section 1]). *Let k be a number field. A mixed Tate motive M is called *unramified* if for every subquotient E of M which defines an element in some $\text{Ext}_{\mathcal{MTM}_{\text{gm}}}^1(\mathbb{Q}(n), \mathbb{Q}(n+1)) = k^\times \otimes_{\mathbb{Z}} \mathbb{Q}$, the class is already in $\mathcal{O}_k^\times \otimes_{\mathbb{Z}} \mathbb{Q}$.*

Let $\mathcal{MTM}^f \subset \mathcal{MTM}_{\text{gm}}$ be the full subcategory of unramified mixed Tate motives.

The category also goes by the name of *mixed Tate motives over \mathcal{O}_k* . Heuristically, we want motives over \mathbb{Q} which have a preimage in the category of motives over \mathbb{Z} . The above definition is an unconditional replacement. The condition can be tested on the Galois realisation.

Lemma 6.4.7 ([DG05, Proposition 1.7], [Yam10, Theorem 4.2]). *Let M be a mixed Tate motive over k . Let p be a prime number and M_p the p -adic realisation of M . Let v be a finite place of k .*

1. *If v is prime to p , then M_p is unramified at v , i.e., the inertia group I_v operates trivially.*
2. *If v divides p , then M_p is crystalline as a representation of $\text{Gal}(\bar{k}_v/k_v)$, i.e., the k -dimension of $D_p(M_p) := (B_{\text{crys}} \otimes_{\mathbb{Q}_p} M_p)^{\text{Gal}(\bar{k}/k)}$ is equal to the \mathbb{Q}_p -dimension of M_p .*

Conversely, a mixed Tate motive is unramified if for every prime ideal v there is a prime number p such that condition 1. or 2., respectively, is satisfied for one p .

Proof. We follow the argument of [DG05] for the case p prime to v . Let M be an unramified Tate motive over \mathcal{O}_k . Hence its p -adic realisation M_p is a finite iterated extension of modules of the form $\mathbb{Q}_p(-i)$. It carries a weight filtration $W_{2i}M_p$ such that $W_{2i}M_p/W_{2i-2}M_p \cong \mathbb{Q}_p^{n_i}(-i)$, i.e., $\mathbb{Q}_p(-i)$ is pure of weight $2i$. By assumption, the subextensions

$$0 \rightarrow W_{2i-2}M_p/W_{2i-4} \rightarrow W_{2i}M_p/W_{2i-4}M_p \rightarrow W_{2i}M_p/W_{2i-4}M_p \rightarrow 0$$

are induced from sums of Kummer extensions characterised by $u \in \mathcal{O}_k^\times \otimes_{\mathbb{Z}} \mathbb{Q}$. This implies that I_p operates trivially on the term in the middle. For the general case, we argue by induction on the length of the weight filtration. We consider a non-trivial sequence

$$0 \rightarrow W_{2i}M_p \rightarrow M_p \rightarrow M_p/W_{2i}M_p \rightarrow 0.$$

By the inductive hypothesis, I_v operates trivially on the outer terms. The claim is equivalent to the vanishing of the boundary morphism

$$\partial : M_p/W_{2i}M_p \rightarrow H^1(I_v, W_{2i}M_p) \cong (W_{2i}M_p)_{I_v}(-1).$$

Note that the domain of this boundary morphism has weights a least $2i + 2$ and the range has weights at most $2i + 2$. We restrict to the submodule $W_{2i+2}M_p$. The subextension is unramified by the inductive hypothesis, hence its boundary map vanishes. This implies that ∂ factors via $M_p/W_{2i+1}M_p$. It vanishes for weight reasons.

The case $v \mid p$ is due to Yamashita. The argument is analogous to the above. We refer to [Yam10, Theorem 4.2] for full details. \square

Corollary 6.4.8 ([DG05]). *The mixed realisation functor $H_{\mathcal{M}\mathcal{R}}^0$ is fully faithful on \mathcal{MTM}^f with image closed under subquotients.*

Part II
Nori Motives

Chapter 7

Nori's diagram category

We explain Nori's construction of an abelian category attached to the representation of a diagram and establish some properties for it. The construction is completely formal. It mimics the standard construction of the Tannakian dual of a rigid tensor category with a fibre functor. Only, we do not have a tensor product or even a category but only what we should think of as the fibre functor.

The results are due to Nori. Notes from some of his talks are available [Nor00, Nora]. There is also a sketch in Levine's survey [Lev05, §5.3]. In the proofs of the main results we follow closely the diploma thesis of von Wangenheim in [vW11].

We start by giving a summary of the main results before giving full proofs beginning in Section 7.2.

7.1 Main results

7.1.1 Diagrams and representations

Let R be a noetherian, commutative ring with unit.

Definition 7.1.1. A *diagram* D is a directed graph on a set of vertices $V(D)$ and edges $E(D)$. A *diagram with identities* is a diagram together with a choice of a distinguished edge $\text{id}_v : v \rightarrow v$ for every $v \in V(D)$. A diagram is called *finite* if it has only finitely many vertices. A *finite full subdiagram* of a diagram D is a diagram containing a finite subset of vertices of D and all edges (in D) between them.

By abuse of notation we often write $v \in D$ instead of $v \in V(D)$. The set of all directed edges between $p, q \in D$ is denoted by $D(p, q)$.

Remark 7.1.2. In the literature, the terminology *quiver* is also quite frequent. Note, however, that a finite quiver is usually only allowed to have finitely many edges. We prefer to stay away from the notion.

Following Nori, one may think of a diagram as a category where composition of morphisms is not defined. Conversely, every small category defines a diagram with identities. The notion of a diagram with identity edges is not standard. The notion is useful later when we consider multiplicative structures.

Example 7.1.3. Let \mathcal{C} be a small category. To \mathcal{C} we can associate a diagram $D(\mathcal{C})$ with vertices the set of objects in \mathcal{C} and edges given by morphisms. It is even a diagram with identities. By abuse of notation we usually also write \mathcal{C} for the diagram.

Definition 7.1.4. A *representation* T of a diagram D in a small category \mathcal{C} is a map T of directed graphs from D to $D(\mathcal{C})$. A *representation* T of a diagram D with identities is a representation T such that id is mapped to id .

For $p, q \in D$ and every edge m from p to q we denote their images simply by Tp , Tq and $Tm : Tp \rightarrow Tq$ (mostly without brackets).

Remark 7.1.5. Alternatively, a representation could be defined as a contravariant *functor* from the *path category* $\mathcal{P}(D)$ to \mathcal{C} . Recall that the objects of the path category are the vertices of D , and the morphisms are sequences of directed edges $e_1 e_2 \dots e_n$ for $n \geq 0$ with the edge e_i starting at the end point of e_{i-1} for $i = 2, \dots, n$. Morphisms are composed by concatenating edges. If D is a diagram with identities, we view $\mathcal{P}(D)$ as a diagram by using the same edges as identities, now viewed as a path of length one. Note that this is in conflict with the more natural choice of the empty word as the identity edge, which, however, does not fit our application in Remark 8.1.6.

We are particularly interested in representations in categories of modules.

Definition 7.1.6. Let R be a noetherian commutative ring with unit. By $R\text{-Mod}$ we denote the category of finitely generated R -modules. By $R\text{-Proj}$ we denote the subcategory of finitely generated projective R -modules.

Note that these categories are essentially small, so we will not worry about smallness from now on.

Definition 7.1.7. Let S be a commutative unital R -algebra and $T : D \rightarrow R\text{-Mod}$ a representation. We denote by T_S the representation

$$D \xrightarrow{T} R\text{-Mod} \xrightarrow{\otimes_R S} S\text{-Mod}.$$

Definition 7.1.8. Let T be a representation of D in $R\text{-Mod}$. We define the *ring of endomorphisms* of T by

$$\text{End}(T) := \left\{ (e_p)_{p \in D} \in \prod_{p \in D} \text{End}_R(Tp) \mid e_q \circ Tm = Tm \circ e_p \ \forall p, q \in D \ \forall m \in D(p, q) \right\}.$$

Remark 7.1.9. In other words, an element of $\text{End}(T)$ consists of tuples $(e_p)_{p \in V(D)}$ of endomorphisms of the various Tp 's, such that all diagrams of the following form commute:

$$\begin{array}{ccc} Tp & \xrightarrow{Tm} & Tq \\ \downarrow e_p & & \downarrow e_q \\ Tp & \xrightarrow{Tm} & Tq \end{array}$$

Note that the ring of endomorphisms does not change when we replace D by the path category $\mathcal{P}(D)$.

7.1.2 Explicit construction of the diagram category

The diagram category can be characterised by a universal property, but it also has a simple explicit description that we give first.

Definition 7.1.10 (Nori). Let R be a noetherian commutative ring with unit. Let T be a representation of D in $R\text{-Mod}$.

1. Assume D is finite. Then we put

$$\mathcal{C}(D, T) = \text{End}(T)\text{-Mod},$$

the category of finitely generated R -modules equipped with an R -linear operation of the algebra $\text{End}(T)$.

2. In general, let

$$\mathcal{C}(D, T) = 2\text{-colim}_F \mathcal{C}(F, T|_F),$$

where F runs through the system of finite full subdiagrams of D .

More explicitly (explaining the 2-colim): the objects of $\mathcal{C}(D, T)$ are the objects of $\mathcal{C}(F, T|_F)$ for some finite subdiagram F . For $X \in \mathcal{C}(F, T|_F)$ and $F \subset F'$ we write $X_{F'}$ for the image of X in $\mathcal{C}(F', T|_{F'})$. For objects $X, Y \in \mathcal{C}(D, T)$, we put

$$\text{Mor}_{\mathcal{C}(D, T)}(X, Y) = \varinjlim_F \text{Mor}_{\mathcal{C}(F, T|_F)}(X_F, Y_F).$$

The category $\mathcal{C}(D, T)$ is called the *diagram category*. By

$$f_T : \mathcal{C}(D, T) \longrightarrow R\text{-Mod}$$

we denote the forgetful functor.

- Remark 7.1.11.** 1. The representation $T : D \longrightarrow \mathcal{C}(D, T)$ extends to a functor on the path category $\mathcal{P}(D)$. By construction the diagram categories $\mathcal{C}(D, T)$ and $\mathcal{C}(\mathcal{P}(D), T)$ agree. The point of view of the path category will be useful in Chapter 8, in particular in Definition 8.2.1.
2. There is no need to distinguish between diagrams and diagrams with identities at this point. We have asked the representation to map the identity edges to the identity map. Hence compatibility of a tuple of endomorphisms with this edge is automatic.

In Section 7.5 we will prove that under additional conditions for R , satisfied in the cases of most interest, there is the following even more direct description of $\mathcal{C}(D, T)$ as comodules over a coalgebra.

Theorem 7.1.12. *If the representation T takes values in finitely generated projective modules over a field or a Dedekind domain R , then the diagram category is equivalent to the category of finitely generated comodules (see Definition 7.5.6) over the coalgebra $A(D, T)$, where*

$$A(D, T) = \text{colim}_F A(F, T) = \text{colim}_F \text{End}(T|_F)^\vee,$$

with F running through the system of all finite subdiagrams of D and $^\vee$ denoting the R -dual.

The proof of this theorem is given in Section 7.5.

7.1.3 Universal property: statement

Theorem 7.1.13 (Nori). *Let D be a diagram and*

$$T : D \longrightarrow R\text{-Mod}$$

a representation of D . Then there exists an R -linear abelian category $\mathcal{C}(D, T)$, together with a representation

$$\tilde{T} : D \longrightarrow \mathcal{C}(D, T),$$

and a faithful, exact, R -linear functor f_T , such that:

1. T factorises over $D \xrightarrow{\tilde{T}} \mathcal{C}(D, T) \xrightarrow{f_T} R\text{-Mod}$.
2. \tilde{T} satisfies the following universal property: given
 - a. another R -linear, abelian category \mathcal{A} ,
 - b. an R -linear, faithful, exact functor, $f : \mathcal{A} \rightarrow R\text{-Mod}$,

c. another representation $F : D \rightarrow \mathcal{A}$,

such that $f \circ F = T$, then there exists a faithful exact functor $L(F)$ — unique up to unique isomorphism of additive exact functors — such that the following diagram commutes:

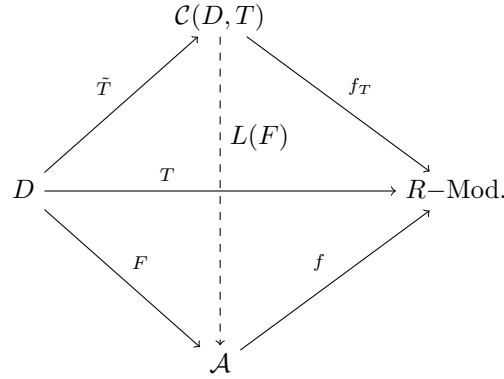

The category $\mathcal{C}(D, T)$ together with \tilde{T} and f_T is uniquely determined by this property up to unique equivalence of categories. It is explicitly described by the diagram category of Definition 7.1.10. It is functorial in D in the obvious sense.

The proof will be given in Section 7.4. We are going to view f_T as an extension of T from D to $\mathcal{C}(D, T)$ and sometimes write simply T instead of f_T .

Remark 7.1.14. It is worth stressing the *faithfulness* of all functors involved. All categories can be viewed as non-full subcategories of $R\text{-Mod}$.

The above universal property already determines the diagram category up to unique equivalence of categories. It can be generalised in two directions: we do not need strict commutativity of the diagram but can allow an isomorphism of representations; and it is enough to have this property after extension of scalars.

Corollary 7.1.15. Let D, R, T be as in Theorem 7.1.13. Let \mathcal{A} and f, F be as in loc. cit. 2. (a)–(c). Moreover, let S be a faithfully flat commutative unitary R -algebra S and

$$\phi : T_S \rightarrow (f \circ F)_S$$

an isomorphism of representations into $S\text{-Mod}$. Then there exists a faithful exact functor $L(F) : \mathcal{C}(D, T) \rightarrow \mathcal{A}$ and an isomorphism of functors

$$\tilde{\phi} : (f_T)_S \rightarrow f_S \circ L(F)$$

such that

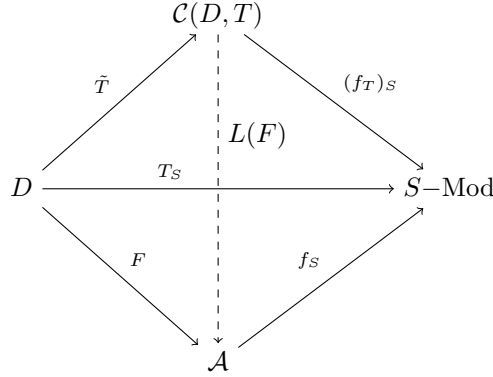

commutes up to ϕ and $\tilde{\phi}$. The pair $(L(F), \tilde{\phi})$ is unique up to unique isomorphism of additive exact functors.

The proof will also be given in Section 7.4.

The following properties provide a better understanding of the nature of the category $\mathcal{C}(D, T)$.

- Proposition 7.1.16.** 1. As an abelian category $\mathcal{C}(D, T)$ is generated by the $\tilde{T}v$ where v runs through the set of vertices of D , i.e., it agrees with its smallest full subcategory containing all such $\tilde{T}v$ and such that the inclusion is exact.
2. Each object of $\mathcal{C}(D, T)$ is a subquotient of a finite direct sum of objects of the form $\tilde{T}v$.
3. If $\alpha : v \rightarrow v'$ is an edge in D such that $T\alpha$ is an isomorphism, then $\tilde{T}\alpha$ is also an isomorphism.

Proof. Let $\mathcal{C}' \subset \mathcal{C}(D, T)$ be the abelian subcategory generated by all $\tilde{T}v$ and closed under kernels and cokernels. By definition, the representation \tilde{T} factors through \mathcal{C}' . By the universal property of $\mathcal{C}(D, T)$, we obtain a faithful exact functor $\mathcal{C}(D, T) \rightarrow \mathcal{C}'$, hence an equivalence of subcategories of $R\text{-Mod}$.

The second statement follows from the first criterion since the full subcategory in $\mathcal{C}(D, T)$ of subquotients of finite direct sums is abelian, hence agrees with $\mathcal{C}(D, T)$. The assertion on morphisms follows since the functor $f_T : \mathcal{C}(D, T) \rightarrow R\text{-Mod}$ is faithful and exact between abelian categories. The kernel and cokernel of $\tilde{T}\alpha$ vanish if the kernel and cokernel of $T\alpha$ vanish. \square

Remark 7.1.17. We will later give a direct proof, see Proposition 7.3.24. It will be used in the proof of the universal property.

The diagram category only weakly depends on T .

Corollary 7.1.18. Let D be a diagram and $T, T' : D \rightarrow R\text{-Mod}$ be two representations. Let S be a faithfully flat R -algebra and $\phi : T_S \rightarrow T'_S$ be an isomorphism of representations in $S\text{-Mod}$. Then it induces an equivalence of categories

$$\Phi : \mathcal{C}(D, T) \rightarrow \mathcal{C}(D, T').$$

Proof. We apply the universal property of Corollary 7.1.15 to the representation T and the abelian category $\mathcal{A} = \mathcal{C}(D, T')$. This yields a functor $\Phi : \mathcal{C}(D, T) \rightarrow \mathcal{C}(D, T')$. By interchanging the role of T and T' we also get a functor Φ' in the opposite direction. We claim that they are inverse to each other. The composition $\Phi' \circ \Phi$ can be seen as the universal functor for the representation of D in the abelian category $\mathcal{C}(D, T)$ via T . By the uniqueness part of the universal property, it is the identity. \square

Corollary 7.1.19. *Let D_2 be a diagram. Let $T_2 : D_2 \rightarrow R\text{-Mod}$ be a representation. Let*

$$D_2 \xrightarrow{\tilde{T}_2} \mathcal{C}(D_2, T_2) \xrightarrow{f_{T_2}} R\text{-Mod}$$

be the factorisation via the diagram category.

Let $D_1 \subset D_2$ be a full subdiagram. It has the representation $T_1 = T_2|_{D_1}$ obtained by restricting T_2 . Let

$$D_1 \xrightarrow{T_1} \mathcal{C}(D_1, T_1) \xrightarrow{f_{T_1}} R\text{-Mod}$$

be the factorisation via the diagram category. Let $\iota : \mathcal{C}(D_1, T_1) \rightarrow \mathcal{C}(D_2, T_2)$ be the functor induced from the inclusion of diagrams. Moreover, we assume that there is a representation $F : D_2 \rightarrow \mathcal{C}(D_1, T_1)$ compatible with T_2 , i.e., such that there is an isomorphism of functors

$$T_2 \rightarrow f_{T_2} \circ \iota \circ F = f_{T_1} \circ F.$$

Then ι is an equivalence of categories.

Proof. Let $T'_2 = f_{T_1} \circ F : D_2 \rightarrow R\text{-Mod}$ and $T'_1 = T'_2|_{D_1} : D_1 \rightarrow R\text{-Mod}$. By assumption, the functors T_2 and T'_2 are isomorphic, and so are the functors T_1 and T'_1 .

By the universal property of the diagram category, the representation F induces a faithful exact functor

$$\pi' : \mathcal{C}(D_2, T'_2) \rightarrow \mathcal{C}(D_1, T'_1).$$

It induces $\pi : \mathcal{C}(D_2, T_2)$ by precomposition with the equivalence Φ from Corollary 7.1.18. We claim that $\iota \circ \pi$ and $\pi \circ \iota$ are isomorphic to the respective identity functors.

By the uniqueness part of the universal property, the composition $\iota \circ \pi' : \mathcal{C}(D_2, T'_2) \rightarrow \mathcal{C}(D_2, T_2)$ is induced by the representation $\iota \circ F$ of D_2 in the abelian category $\mathcal{C}(D_2, T_2)$. By the proof of Corollary 7.1.18 this is the equivalence Φ^{-1} . In particular, $\iota \circ \pi$ is the identity.

The argument for $\pi \circ \iota$ on $\mathcal{C}(D_1, T_1)$ is analogous. \square

The most important ingredient for the proof of the universal property is the following special case.

Theorem 7.1.20. *Let R be a noetherian ring and \mathcal{A} an abelian, R -linear category. Let*

$$T : \mathcal{A} \longrightarrow R\text{-Mod}$$

be a faithful, exact, R -linear functor and

$$\mathcal{A} \xrightarrow{\tilde{T}} \mathcal{C}(\mathcal{A}, T) \xrightarrow{f_T} R\text{-Mod}$$

the factorisation via its diagram category (see Definition 7.1.10). Then \tilde{T} is an equivalence of categories.

The proof of this theorem will be given in Section 7.3.

7.1.4 Discussion of the Tannakian case

The above construction of $\mathcal{C}(\mathcal{A}, T)$ may be viewed as a generalisation of Tannaka duality. In this subsection, we will explain Tannaka duality in more detail. We are not going to use the following considerations in the sequel.

Let k be a field, \mathcal{C} a k -linear abelian tensor category, and

$$T : \mathcal{C} \longrightarrow k\text{-Vect}$$

a k -linear faithful tensor functor, all in the sense of [DM82]. By standard Tannakian formalism (cf [SR72] and [DM82]), there is a k -bialgebra A such that the category is equivalent to the category of A -comodules on finite-dimensional k -vector spaces.

On the other hand, if we regard \mathcal{C} as a diagram (with identities) and T as a representation into finite-dimensional vector spaces, we can view the diagram category of \mathcal{C} as the category $A(\mathcal{C}, T)\text{-Comod}$ by Theorem 7.1.12. By Theorem 7.1.20 the category \mathcal{C} is equivalent to its diagram category $A(\mathcal{C}, T)\text{-Comod}$. The construction of the two coalgebras A and $A(\mathcal{C}, T)$ coincides. Thus Nori implicitly shows that we can recover the coalgebra structure of A just by looking at the representations of \mathcal{C} .

The algebra structure on $A(\mathcal{C}, T)$ is induced from the tensor product on \mathcal{C} . (This is actually a special case of our considerations in Section 8.1.) This defines a pro-algebraic scheme $\text{Spec}(A(\mathcal{C}, T))$. The coalgebra structure turns $\text{Spec}(A(\mathcal{C}, T))$ into a monoid scheme. We may interpret $A(\mathcal{C}, T)\text{-Comod}$ as the category of finite-dimensional representations of this monoid scheme.

If, in addition, the tensor structure is rigid, $\mathcal{C}(D, T)$ becomes what Deligne and Milne call a *neutral Tannakian category* [DM82]. The rigidity structure induces an antipodal map, making $A(\mathcal{C}, T)$ into a Hopf algebra. This yields the structure of a *group scheme* on $\text{Spec}(A(\mathcal{C}, T))$, rather than only a monoid scheme. (This is a special case of our considerations in Section 8.3.)

We record the outcome of the discussion:

Theorem 7.1.21. *Let R be a field and \mathcal{C} be a neutral R -linear Tannakian category with faithful exact fibre functor $T : \mathcal{C} \rightarrow R\text{-Mod}$. Then $A(\mathcal{C}, T)$ is equal to the Hopf algebra of the Tannakian dual.*

Proof. By construction, see [DM82, Theorem 2.11] and its proof. \square

As a byproduct of our generalisations, we are actually going to give a full proof of Tannaka duality, see Remark 8.3.5.

A similar result holds in the case when R is a Dedekind domain and

$$T : D \longrightarrow R\text{-Proj}$$

a representation into finitely generated projective R -modules. Again by Theorem 7.1.12, the diagram category $\mathcal{C}(D, T)$ equals $A(\mathcal{C}, T)\text{-Comod}$, where $A(\mathcal{C}, T)$ is projective over R . Wedhorn shows in [Wed04] that if $\text{Spec}(A(\mathcal{C}, T))$ is a group scheme it is the same to have a representation of $\text{Spec}(A(\mathcal{C}, T))$ on a finitely generated R -module M and to endow M with an $A(\mathcal{C}, T)$ -comodule structure.

7.2 First properties of the diagram category

Let R be a unitary commutative noetherian ring, D a diagram and $T : D \rightarrow R\text{-Mod}$ a representation. We investigate the category $\mathcal{C}(D, T)$ introduced in Definition 7.1.10.

Lemma 7.2.1. *If D is a finite diagram, then $\text{End}(T)$ is an R -algebra which is finitely generated as an R -module.*

Proof. For any $p \in D$ the module Tp is finitely generated. Since R is noetherian, the algebra $\text{End}_R(Tp)$ is then finitely generated as an R -module. Thus $\text{End}(T)$ becomes a unitary subalgebra of $\prod_{p \in \text{Ob}(D)} \text{End}_R(Tp)$. Since $V(D)$ is finite and R is noetherian,

$$\text{End}(T) \subset \prod_{p \in \text{Ob}(D)} \text{End}_R(Tp)$$

is finitely generated as an R -module. \square

Lemma 7.2.2. *Let D be a finite diagram and $T : D \rightarrow R\text{-Mod}$ a representation. Then:*

1. *Let S be a flat R -algebra. Then:*

$$\text{End}_S(T_S) = \text{End}_R(T) \otimes S.$$

2. Let $F : D' \rightarrow D$ be a morphism of diagrams and $T' = T \circ F$ the induced representation. Then F induces a canonical R -algebra homomorphism

$$F^* : \text{End}(T) \rightarrow \text{End}(T').$$

Proof. The algebra $\text{End}(T)$ is defined as a limit, i.e., a kernel

$$0 \rightarrow \text{End}(T) \rightarrow \prod_{p \in V(D)} \text{End}_R(Tp) \xrightarrow{\phi} \prod_{p, q \in V(D)} \prod_{m \in D(p, q)} \text{Hom}_R(Tp, Tq)$$

with $\phi(p)(m) = e_q \circ Tm - Tm \circ e_p$. As S is flat over R , this remains exact after tensoring with S .

The set $V(D)$ is finite, but $D(p, q)$ not necessarily. Let $M \subset \text{Hom}_R(Tp, Tq)$ be the submodule generated by $m \in D(p, q)$. As R is noetherian and the modules Tp, Tq are finitely generated over R , the module M is also finitely generated. Let $G(p, q)$ be a finite set of generators of M . We then have

$$0 \rightarrow \text{End}(T) \rightarrow \prod_{p \in V(D)} \text{End}_R(Tp) \xrightarrow{\psi} \prod_{p, q \in V(D)} \prod_{g \in E(p, q)} \text{Hom}_R(Tp, Tq)$$

with $\psi(p)(g) = e_q \circ g - g \circ e_p$. The tensor product and the direct product commute because the products are finite. As the R -module Tp is finitely presented and S flat, we have

$$\text{End}_R(Tp) \otimes S = \text{End}_S(T_S p), \quad \text{Hom}_R(Tp, Tq) \otimes S = \text{Hom}_S(T_S(p), T_S(q)).$$

Hence we get

$$0 \rightarrow \text{End}(T) \otimes S \rightarrow \prod_{p \in V(D)} \text{End}_S(T_S(p)) \xrightarrow{\psi} \prod_{p, q \in V(D)} \prod_{g \in G(p, q)} \text{Hom}_S(T_S(p), T_S(q)).$$

We claim that this is the defining sequence for $\text{End}(T_S)$. Indeed, by flatness of S over R , the S -submodule of $\text{Hom}_S(T_S(p), T_S(q))$ generated by the elements $T_S(m)$ for $m \in E(p, q)$ is just $M \otimes_R S$. Again by flatness, it is indeed generated over S by $G(p, q)$.

The morphism of diagrams $F : D' \rightarrow D$ induces a homomorphism

$$\prod_{p \in V(D)} \text{End}_R(Tp) \rightarrow \prod_{p' \in V(D')} \text{End}_R(T'p'),$$

by mapping $e = (e_p)_p$ to $F^*(e)$ with $(F^*(e))_{p'} = e_{F(p')}$ in $\text{End}_R(T'p') = \text{End}_R(TF(p'))$. It is compatible with the induced homomorphism

$$\prod_{p,q \in V(D)} \prod_{m \in D(p,q)} \text{Hom}_R(Tp, Tq) \rightarrow \prod_{p',q' \in V(D')} \prod_{m' \in D'(p',q')} \text{Hom}_R(T'p', T'q').$$

Hence it induces a homomorphism on the kernels. \square

Proposition 7.2.3. *Let R be a unitary commutative noetherian ring, D a finite diagram and $T : D \rightarrow R\text{-Mod}$ be a representation. For any $p \in D$ the object Tp is a natural left $\text{End}(T)$ -module. This induces a representation*

$$\tilde{T} : D \rightarrow \text{End}(T)\text{-Mod},$$

such that T factorises via

$$D \xrightarrow{\tilde{T}} \mathcal{C}(D, T) \xrightarrow{f_T} R\text{-Mod}.$$

Proof. For all $p \in D$ the projection

$$pr : \text{End}(T) \rightarrow \text{End}_R(Tp)$$

induces a well-defined action of $\text{End}(T)$ on Tp making Tp into a left $\text{End}(T)$ -module. To check that \tilde{T} is a representation of left $\text{End}(T)$ -modules, we need $Tm \in \text{Hom}_R(Tp, Tq)$ to be $\text{End}(T)$ -linear for all $p, q \in D, m \in D(p, q)$. This corresponds directly to the commutativity of the diagram in Remark 7.1.9. \square

Now let D be general, i.e., not necessarily finite. We study the system of finite subdiagrams $F \subset D$. Recall that subdiagrams are full, i.e., they have the same edges as in D .

Corollary 7.2.4. *The finite subdiagrams of D induce a directed system of abelian categories $(\mathcal{C}(D, T|_F))_{\substack{F \subset D \\ \text{finite}}}$ with exact, faithful R -linear functors as transition maps.*

Proof. Let $F' \subset F$ be an inclusion of finite subdiagrams. By Lemma 7.2.2, this induces an algebra homomorphism $\text{End}(T|_F) \rightarrow \text{End}(T|_{F'})$. From this we obtain a faithful exact functor

$$\text{End}(T|_{F'})\text{-Mod} \rightarrow \text{End}(T|_F)\text{-Mod}.$$

These are the transition functors. \square

Recall that we want to define $\mathcal{C}(D, T)$ as 2-colimit of this system, see Definition 7.1.10.

Proposition 7.2.5. *The 2-colimit $\mathcal{C}(D, T)$ exists. It provides an R -linear abelian category such that the composition of the induced representation with the forgetful functor*

$$\begin{array}{ccc} D & \xrightarrow{\tilde{T}} & \mathcal{C}(D, T) & \xrightarrow{f_T} & R\text{-Mod} \\ p & \mapsto & Tp & \mapsto & Tp \end{array}$$

yields a factorisation of T . The functor f_T is R -linear, faithful and exact.

Proof. It is a straightforward calculation that the limit category inherits all structures of an R -linear abelian category. It has well-defined (co)products and (co)kernels because the transition functors are exact. It has a well-defined R -linear structure as all transition functors are R -linear. Finally, one shows that every kernel resp. cokernel is a monomorphism resp. epimorphism using the fact that all transition functors are faithful and exact.

By construction, for every $p \in D$ the R -module Tp becomes an $\text{End}(T|_F)$ -module for all finite $F \subset D$ with $p \in F$. Thus it represents an object in $\mathcal{C}(D, T)$. This induces a representation

$$\begin{array}{ccc} D & \xrightarrow{\tilde{T}} & \mathcal{C}(D, T) \\ p & \mapsto & Tp. \end{array}$$

The forgetful functor is exact, faithful and R -linear. Composition with the forgetful functor f_T obviously yields the initial diagram T . \square

We now consider functoriality in D .

Lemma 7.2.6. *Let D_1, D_2 be diagrams and $G : D_1 \rightarrow D_2$ a map of diagrams. Let further $T : D_2 \rightarrow R\text{-Mod}$ be a representation and*

$$D_2 \xrightarrow{\tilde{T}} \mathcal{C}(D_2, T) \xrightarrow{f_T} R\text{-Mod}$$

the factorisation of T through the diagram category $\mathcal{C}(D_2, T)$ as constructed in Proposition 7.2.5. Let

$$D_1 \xrightarrow{\widetilde{T \circ G}} \mathcal{C}(D_1, T \circ G) \xrightarrow{f_{T \circ G}} R\text{-Mod}$$

be the factorisation of $T \circ G$.

Then there exists a faithful R -linear, exact functor \mathcal{G} , such that the following diagram commutes.

$$\begin{array}{ccc} D_1 & \xrightarrow{\quad G \quad} & D_2 \\ \downarrow \widetilde{T \circ G} & & \downarrow \tilde{T} \\ \mathcal{C}(D_1, T \circ G) & \xrightarrow{\quad \mathcal{G} \quad} & \mathcal{C}(D_2, T) \\ \swarrow f_{T \circ G} & & \searrow f_T \\ & R\text{-Mod} & \end{array}$$

Proof. Let D_1, D_2 be finite diagrams first. Let $T_1 = T \circ G$ and $T_2 = T$. The homomorphism

$$G^* : \text{End}(T_2) \rightarrow \text{End}(T_1)$$

of Lemma 7.2.2 induces by restriction of scalars a functor on diagram categories, as required.

Let now D_1 be finite and D_2 arbitrary. Let E_2 be a finite full subdiagram of D_2 containing $G(D_1)$. We apply the finite case to $G|_{D_1} : D_1 \rightarrow E_2$ and obtain a functor

$$\mathcal{C}(D_1, T \circ G) \rightarrow \mathcal{C}(E_2, T|_{E_2})$$

which we compose with the canonical functor $\mathcal{C}(E_2, T|_{E_2}) \rightarrow \mathcal{C}(D_2, T)$. By functoriality, it is independent of the choice of E_2 .

Let now D_1 and D_2 be arbitrary. For every finite subdiagram $E_1 \subset D_1$ we have constructed

$$\mathcal{C}(E_1, T \circ G|_{E_1}) \rightarrow \mathcal{C}(D_2, T).$$

They are compatible and hence define a functor on the colimit. \square

Isomorphic representations have equivalent diagram categories. More precisely:

Lemma 7.2.7. *Let $T_1, T_2 : D \rightarrow R\text{-Mod}$ be representations and $\phi : T_1 \rightarrow T_2$ an isomorphism of representations. Then ϕ induces an equivalence of categories $\Phi : \mathcal{C}(D, T_1) \rightarrow \mathcal{C}(D, T_2)$ together with an isomorphism of representations*

$$\tilde{\phi} : \Phi \circ \tilde{T}_1 \rightarrow \tilde{T}_2$$

such that $f_{T_2} \circ \tilde{\phi} = \phi$.

Proof. We only sketch the argument since it is analogous to the proof of Lemma 7.2.6.

It suffices to consider the case $D = F$ finite. The functor

$$\Phi : \text{End}(T_1)\text{-Mod} \rightarrow \text{End}(T_2)\text{-Mod}$$

is the extension of scalars for the R -algebra isomorphism $\text{End}(T_1) \rightarrow \text{End}(T_2)$ induced by conjugating by ϕ . \square

Lemma 7.2.8. *Let D be a diagram and $T : D \rightarrow R\text{-Mod}$ a representation. Let S be a flat R -algebra. Then there is a natural faithful R -linear functor*

$$-\otimes_R S : \mathcal{C}(D, T) \rightarrow \mathcal{C}(D, T_S)$$

compatible with the functor $-\otimes_R S : R\text{-Mod} \rightarrow S\text{-Mod}$.

Proof. It suffices to consider the case of finite diagrams. By construction, the statement now follows from Lemma 7.2.2. \square

7.3 The diagram category of an abelian category

In this section we give the proof of Theorem 7.1.20: the diagram category of an abelian category with respect to a representation given by an exact faithful functor is the abelian category itself. In the case of fields, the proof is also given in Nori's thesis, see [Nor82, Appendix].

We fix a commutative noetherian ring R with unit and an R -linear abelian category \mathcal{A} . By an R -algebra we mean a unital R -algebra, not necessarily commutative. Recall that $R\text{-Mod}$ is the category of finitely generated R -modules.

7.3.1 A calculus of tensors

We start with some general constructions of functors. We fix a unital R -algebra E , finitely generated as an R -module, not necessarily commutative. The most important case is $E = R$, but this is not enough for our application.

In the simpler case where R is a field, most of the constructions in this section can already be found in [DMOS82].

Definition 7.3.1. Let E be an R -algebra which is finitely generated as an R -module. We denote by $E\text{-Mod}$ the category of finitely generated left E -modules.

The algebra E and the objects of $E\text{-Mod}$ are noetherian because R is.

Definition 7.3.2. Let \mathcal{A} be an R -linear abelian category and p be an object of \mathcal{A} . Let E be a not necessarily commutative R -algebra and

$$E^{op} \xrightarrow{f} \text{End}_{\mathcal{A}}(p)$$

be a morphism of R -algebras. We say that p is a *right E -module in \mathcal{A}* .

Example 7.3.3. Let \mathcal{A} be the category of left R' -modules for some R -algebra R' . Then a right E -module in \mathcal{A} is the same thing as an (R', E) -bimodule, i.e., a left R' -module with a compatible structure of a right E -module.

Lemma 7.3.4. Let \mathcal{A} be an R -linear abelian category in which all Hom-modules are finitely generated. Let p be an object of \mathcal{A} . Let E be a not necessarily commutative R -algebra and p a right E -module in \mathcal{A} . Then

$$\text{Hom}_{\mathcal{A}}(p, -) : \mathcal{A} \rightarrow R\text{-Mod}$$

can naturally be viewed as a functor to $E\text{-Mod}$.

Proof. For every $q \in \mathcal{A}$, the algebra E operates on $\text{Hom}_{\mathcal{A}}(p, q)$ in the obvious way. \square

Proposition 7.3.5. *Let \mathcal{A} be an R -linear abelian category in which all Hom -modules are finitely generated. Let p be an object of \mathcal{A} . Let E be a not necessarily commutative R -algebra and p a right E -module in \mathcal{A} . Then the functor*

$$\text{Hom}_{\mathcal{A}}(p, -) : \mathcal{A} \longrightarrow E\text{-Mod}$$

has an R -linear left adjoint

$$p \otimes_E - : E\text{-Mod} \longrightarrow \mathcal{A}.$$

It is right exact. It satisfies

$$p \otimes_E E = p,$$

and on endomorphisms of the object E we have (using $\text{End}_E(E) \cong E^{\text{op}}$)

$$\begin{aligned} p \otimes_E - : \text{End}_E(E) &\longrightarrow \text{End}_{\mathcal{A}}(p) \\ a &\longmapsto f(a). \end{aligned}$$

Proof. Right exactness of $p \otimes_E -$ follows from the universal property. For every $M \in E\text{-Mod}$, the value of $p \otimes_E M$ is uniquely determined up to unique isomorphism by the universal property.

In order to show existence, we are going to deduce an explicit description for more and more general M . In the case of $M = E$, the universal property is satisfied by p itself because we have for all $q \in \mathcal{A}$

$$\text{Hom}_{\mathcal{A}}(p, q) = \text{Hom}_E(E, \text{Hom}_{\mathcal{A}}(p, q)).$$

This identification also implies the formula on endomorphisms of $M = E$.

By compatibility with direct sums, this implies that $p \otimes_E E^n \cong \bigoplus_{i=1}^n p$ for free E -modules. For the same reason, morphisms $E^m \xrightarrow{(a_{ij})_{ij}} E^n$ between free E -modules must be mapped to $\bigoplus_{j=1}^m p \xrightarrow{f(a_{ij})_{ij}} \bigoplus_{i=1}^n p$.

Let M be a finitely presented left E -module. We fix a finite presentation

$$E^{m_1} \xrightarrow{(a_{ij})_{ij}} E^{m_0} \xrightarrow{\pi_a} M \rightarrow 0.$$

Since $p \otimes_E -$ preserves cokernels (if $p \otimes_E -$ exists), we need to define

$$p \otimes_E M := \text{Coker}(p^{m_1} \xrightarrow{\tilde{A} := f(a_{ij})_{ij}} p^{m_0}).$$

We check that it satisfies the universal property. Indeed, for all $q \in \mathcal{A}$, we have a commutative diagram

$$\begin{array}{ccccccc} \text{Hom}_{\mathcal{A}}(p \otimes E^{m_1}, q) & \longleftarrow & \text{Hom}_{\mathcal{A}}(p \otimes E^{m_0}, q) & \longleftarrow & \text{Hom}_{\mathcal{A}}(p \otimes M, q) & \longleftarrow & 0 \\ \downarrow \cong & & \downarrow \cong & & \downarrow & & \\ \text{Hom}_E(E^{m_1}, \text{Hom}_{\mathcal{A}}(p, q)) & \longleftarrow & \text{Hom}_E(E^{m_0}, \text{Hom}_{\mathcal{A}}(p, q)) & \longleftarrow & \text{Hom}_E(M, \text{Hom}_{\mathcal{A}}(p, q)) & \longleftarrow & 0 \end{array}$$

Hence the dashed arrow exists and is an isomorphism. This finishes the proof of existence.

The universal property implies that $p \otimes_E M$ is independent of the choice of presentation and functorial. We can also make this explicit. For a morphism between arbitrary modules $\varphi : M \rightarrow N$ we choose lifts

$$\begin{array}{ccccccc} E^{m_1} & \xrightarrow{A} & E^{m_0} & \xrightarrow{\pi_A} & M & \longrightarrow & 0 \\ \downarrow \varphi^1 & & \downarrow \varphi^0 & & \downarrow \varphi & & \\ E^{n_1} & \xrightarrow{B} & E^{n_0} & \xrightarrow{\pi_B} & N & \longrightarrow & 0. \end{array}$$

The respective diagram in \mathcal{A} ,

$$\begin{array}{ccccccc} p^{m_1} & \xrightarrow{\tilde{A}} & p^{m_0} & \xrightarrow{\pi_{\tilde{A}}} & \text{Coker}(\tilde{A}) & \longrightarrow & 0 \\ \downarrow \tilde{\varphi}^1 & & \downarrow \tilde{\varphi}^0 & & \downarrow \exists! & & \\ p^{n_1} & \xrightarrow{\tilde{B}} & p^{n_0} & \xrightarrow{\pi_{\tilde{B}}} & \text{Coker}(\tilde{B}) & \longrightarrow & 0 \end{array}$$

induces a unique morphism $p \otimes_E \varphi : p \otimes_E M \rightarrow p \otimes_E N$ that keeps the diagram commutative. It is independent of the choice of lifts as different lifts of projective resolutions are homotopic. This finishes the construction. \square

Corollary 7.3.6. *Let E be an R -algebra finitely generated as an R -module and \mathcal{A} an R -linear abelian category in which all Hom-modules are finitely generated. Let*

$$T : \mathcal{A} \longrightarrow E\text{-Mod}$$

be an exact, R -linear functor into the category of finitely generated E -modules. Further, let p be a right E -module in \mathcal{A} with structure given by a morphism of R -algebras

$$E^{op} \xrightarrow{f} \text{End}_{\mathcal{A}}(p).$$

Then the composition

$$E^{op} \xrightarrow{f} \text{End}_{\mathcal{A}}(p) \xrightarrow{T} \text{End}_E(Tp)$$

induces a right action on Tp , making it into an E -bimodule. The composition

$$\begin{array}{ccccc} E\text{-Mod} & \xrightarrow{p \otimes_E -} & \mathcal{A} & \xrightarrow{T} & E\text{-Mod} \\ M & \mapsto & p \otimes_E M & \mapsto & T(p \otimes_E M) \end{array}$$

becomes the usual tensor functor of E -modules.

Proof. It is obvious that the composition

$$\begin{array}{ccc} E\text{-Mod} & \xrightarrow{p \otimes_E -} & \mathcal{A} & \xrightarrow{T} & E\text{-Mod} \\ E^n & \mapsto & p \otimes_E E^n & \mapsto & T(p \otimes_E E^n) \end{array}$$

induces the usual tensor functor

$$(Tp) \otimes_E - : E\text{-Mod} \longrightarrow E\text{-Mod}$$

on free E -modules. For arbitrary finitely generated E -modules this follows from the fact that $T(p \otimes_E -)$ is right exact and T is exact. \square

Remark 7.3.7. Let E be an R -algebra, let M be a right E -module and N a left E -module. We obtain the tensor product $M \otimes_E N$ by dividing out the equivalence relation $m \cdot e \otimes n \sim m \otimes e \cdot n$ for all $m \in M, n \in N, e \in E$ of the tensor product $M \otimes_R N$ of R -modules. We will now see that a similar approach holds for the abstract tensor products $p \otimes_R M$ and $p \otimes_E M$ in \mathcal{A} as defined in Proposition 7.3.5. For the easier case that R is a field, this approach has been used in [DM82].

Lemma 7.3.8. *Let \mathcal{A} be an R -linear, abelian category in which all Hom-modules are finitely generated, E a not necessarily commutative R -algebra which is finitely generated as an R -module and $p \in \mathcal{A}$ a right E -module in \mathcal{A} . Let $E' \in E\text{-Mod}$ be, in addition, a right E -module in $E\text{-Mod}$, i.e., an E -bimodule.*

Then $p \otimes_E E'$ is a right E -module in \mathcal{A} and for all $M \in E\text{-Mod}$ we have a natural isomorphism

$$p \otimes_E (E' \otimes_E M) \cong (p \otimes_E E') \otimes_E M.$$

Moreover,

$$(p \otimes_E E) \otimes_R M \cong p \otimes_R M.$$

Proof. The right E -module structure on $p \otimes_E E'$ is defined by functoriality. The isomorphisms are immediate from the universal property. \square

Proposition 7.3.9. *Let \mathcal{A} be an R -linear, abelian category in which all Hom-modules are finitely generated. Let further E be a unital R -algebra which is generated as an R -module by the elements e_1, \dots, e_m . Let p be a right E -module in \mathcal{A} with structure given by*

$$E^{op} \xrightarrow{f} \text{End}_{\mathcal{A}}(p).$$

Let M be a left E -module.

Then $p \otimes_E M$ is isomorphic to the cokernel of the map

$$\Sigma : \bigoplus_{i=1}^m (p \otimes_R M) \longrightarrow p \otimes_R M$$

given by

$$\sum_{i=1}^m (f(e_i) \otimes \text{id}_M - \text{id}_p \otimes e_i \text{id}_M) \pi_i$$

with π_i the projection to the i -summand.

More suggestively (even if not quite correct), we write

$$\Sigma : (x_i \otimes v_i)_{i=1}^m \mapsto \sum_{i=1}^m (f(e_i)(x_i) \otimes v_i - x_i \otimes (e_i \cdot v_i))$$

for $x_i \in p$ and $v_i \in M$.

Proof. Consider the sequence

$$\bigoplus_{i=1}^m E \otimes_R E \longrightarrow E \otimes_R E \longrightarrow E \longrightarrow 0$$

where the first map is given by

$$(x_i \otimes y_i)_{i=1}^m \mapsto \sum_{i=1}^m x_i e_i \otimes y_i - x_i \otimes e_i y_i$$

and the second is multiplication. We claim that it is exact. The sequence is exact in E because E is unital. The composition of the two maps is zero, hence the cokernel maps to E . The elements in the cokernel satisfy the relation $\bar{x} e_i \otimes \bar{y} = \bar{x} \otimes e_i \bar{y}$ for all \bar{x}, \bar{y} and $i = 1, \dots, m$. The e_i generate E , hence $\bar{x} e \otimes \bar{y} = \bar{x} \otimes e \bar{y}$ for all \bar{x}, \bar{y} and all $e \in E$. Hence the cokernel equals $E \otimes_E E$ which is E via the multiplication map.

Now we tensor the sequence from the left by p and from the right by M and obtain an exact sequence

$$\bigoplus_{i=1}^m p \otimes_E (E \otimes_R E) \otimes_E M \longrightarrow p \otimes_E (E \otimes_R E) \otimes_E M \longrightarrow p \otimes_E E \otimes_E M \rightarrow 0.$$

Applying the computation rules of Lemma 7.3.8, we get the sequence in the proposition. \square

Similarly to Proposition 7.3.5 and Corollary 7.3.6, but less general, we construct a contravariant functor $\text{Hom}_R(-, p)$:

Proposition 7.3.10. *Let \mathcal{A} be an R -linear abelian category in which all Hom-modules are finitely generated. Let p be an object of \mathcal{A} . Then the functor*

$$\text{Hom}_{\mathcal{A}}(-, p) : \mathcal{A}^\circ \longrightarrow R\text{-Mod}$$

has a left adjoint

$$\mathrm{Hom}_R(-, p) : R\text{-Mod} \longrightarrow \mathcal{A}^\circ.$$

This means that for all $M \in R\text{-Mod}$ and $q \in \mathcal{A}$, we have

$$\mathrm{Hom}_{\mathcal{A}}(q, \mathrm{Hom}_R(M, p)) = \mathrm{Hom}_R(M, \mathrm{Hom}_{\mathcal{A}}(q, p)).$$

It is left exact and satisfies

$$\mathrm{Hom}_R(R, p) = p.$$

If

$$T : \mathcal{A} \longrightarrow R\text{-Mod}$$

is an exact, R -linear functor into the category of finitely generated R -modules then the composition

$$\begin{array}{ccccc} R\text{-Mod} & \xrightarrow{\mathrm{Hom}(-, p)} & \mathcal{A} & \xrightarrow{T} & R\text{-Mod} \\ M & \mapsto & \mathrm{Hom}_R(M, p) & \mapsto & \mathrm{Hom}_R(M, Tp) \end{array}$$

is the usual $\mathrm{Hom}(-, Tp)$ -functor in $R\text{-Mod}$.

Proof. The arguments are the same as in the proof of Proposition 7.3.5 and Corollary 7.3.6. \square

Remark 7.3.11. Let \mathcal{A} be an R -linear, abelian category in which all Hom -modules are finitely generated. The functors $\mathrm{Hom}_R(-, p)$ as defined in Proposition 7.3.10 and $p \otimes_R -$ as defined in Proposition 7.3.6 are also functorial in p , i.e., we have even functors

$$\mathrm{Hom}_R(-, -) : (R\text{-Mod})^\circ \times \mathcal{A} \longrightarrow \mathcal{A}$$

and

$$- \otimes_R - : \mathcal{A} \times R\text{-Mod} \longrightarrow \mathcal{A}.$$

We will denote the image of a morphism $p \xrightarrow{\alpha} q$ under the functor $\mathrm{Hom}_R(M, -)$ by

$$\mathrm{Hom}_R(M, p) \xrightarrow{\alpha \circ (-)} \mathrm{Hom}_R(M, q).$$

This notation $\alpha \circ (-)$ is natural since by composition

$$\begin{array}{ccccc} \mathcal{A} & \xrightarrow{\mathrm{Hom}(M, -)} & \mathcal{A} & \xrightarrow{T} & R\text{-Mod} \\ p & \mapsto & \mathrm{Hom}_R(M, p) & \mapsto & \mathrm{Hom}_R(M, Tp) \end{array}$$

$T(\alpha \circ (-))$ becomes the usual left action of $T\alpha$ on $\mathrm{Hom}_R(M, Tp)$.

Proof. This follows from the universal property. \square

We will now check that the above functors have properties which are very similar to those of the usual tensor and Hom -functors in $R\text{-Mod}$.

Lemma 7.3.12. *Let \mathcal{A} be an R -linear, abelian category in which all Hom-modules are finitely generated. Let M be a finitely generated R -module. Then the functor $\mathrm{Hom}_R(M, -)$ is right-adjoint to the functor $- \otimes_R M$.*

If

$$T : \mathcal{A} \longrightarrow R\text{-Mod}$$

is an R -linear, exact functor into finitely generated R -modules, the composed functors $T \circ \mathrm{Hom}_R(M, -)$ and $T \circ (- \otimes_R M)$ yield the usual hom-tensor adjunction in $R\text{-Mod}$.

Proof. The assertion follows from the universal property and the identification $T \circ \mathrm{Hom}_R(M, -) = \mathrm{Hom}_R(M, T_-)$ in Proposition 7.3.10 and $T \circ (- \otimes_R M) = (T_-) \otimes_R M$ in Proposition 7.3.6. \square

7.3.2 Construction of the equivalence

We are now investigating an R -linear abelian category \mathcal{A} together with a faithful exact functor $T : \mathcal{A} \rightarrow R\text{-Mod}$. Note that the existence of the faithful functor T implies that all Hom-modules in \mathcal{A} are finitely generated.

Definition 7.3.13. Let \mathcal{A} be an abelian category and \mathcal{S} a class of objects of \mathcal{A} . By $\langle \mathcal{S} \rangle$ we denote the smallest full abelian subcategory of \mathcal{A} containing \mathcal{S} which is closed under kernels and cokernels, i.e., the intersection of all full subcategories of \mathcal{A} that are abelian, contain \mathcal{S} , and for which the inclusion functor is exact.

By $\langle \mathcal{S} \rangle^{\mathrm{psab}}$ we denote the smallest full pseudo-abelian subcategory of \mathcal{A} , i.e., it contains \mathcal{S} and is closed under direct sums and direct summands.

Let $T : \mathcal{A} \rightarrow R\text{-Mod}$ be a faithful exact functor. We first concentrate on the case $\mathcal{A} = \langle p \rangle$. From now on, we abbreviate the diagram algebra (see Definition 7.1.8) $\mathrm{End}(T|_{\langle p \rangle})$ by $E(p)$. The precise relation between $E(p)$ and $\mathcal{C}(\langle p \rangle, T)$ is subtle, see Corollary 7.3.19 below. However, we get away with less for our main result.

Lemma 7.3.14. *We have:*

1. $E(p) = \mathrm{End}(T|_{\langle p \rangle^{\mathrm{psab}}})$;
2. if p is projective and every $q \in \langle p \rangle$ is a quotient of p^n for some n , then $E(p) = \mathrm{End}(T|_{\langle p \rangle})$.

Proof. Let $\alpha = (\alpha_q)_q \in \mathrm{End}(T|_{\langle p \rangle^{\mathrm{psab}}})$. The component $\alpha_{p^n} : (Tp)^n \rightarrow (Tp)^n$ is compatible with the projection $p^n \rightarrow p$ to the factor i and the inclusion $p \rightarrow p^n$ into the factor j . This implies that α_{p^n} is the diagonal map α_p , in particular uniquely determined by α_p . If $p^n = q \oplus q'$, then compatibility of α with the projections implies that $\alpha_q = \alpha_{p^n}|_q$. Hence α_p determines all of α on $\langle p \rangle^{\mathrm{psab}}$. Conversely, given $\alpha_p \in E(p)$, the diagonal extension to p^n is

compatible with all morphisms $p^n \rightarrow p^m$. The restriction to a direct summand q automatically respects q because $p^n \rightarrow q \rightarrow p^n$ is an endomorphism, hence compatible with α_p . All endomorphisms of q extend to p^n , hence they are also compatible with α_p . This proves the first assertion.

We now assume that p is a projective generator. Every object q of $\langle p \rangle$ can be written as a cokernel $q = \text{Coker}(f : p^n \rightarrow p^m)$. Let $(\alpha_q)_q \in \text{End}(T)$. As before, α_{p^m} is determined by α_p . Hence α_q is determined by α_{p^m} on the quotient. Conversely, given $\alpha_p \in E(p)$, it commutes with f and hence it also operates on Tq . Given a morphism $g : q \rightarrow q$ in \mathcal{A} , it lifts to $\tilde{g} : p^m \rightarrow p^m$ because p^m is projective. By definition, α_p commutes with $T\tilde{g}$, hence it also commutes with Tg . \square

Example 7.3.15. Let R be a noetherian commutative unital ring and E an R -algebra finitely generated as an R -module. Let

$$T : E\text{-Mod} \rightarrow R\text{-Mod}$$

be the forgetful functor. The category $E\text{-Mod}$ is generated by the module E . It is a projective generator. Hence by Lemma 7.3.14 2., we have

$$\mathcal{C}(E\text{-Mod}, T) = E'\text{-Mod},$$

where $E' = \text{End}(T|_{\{E\}})$ is the subalgebra of $\text{End}_R(E)$ of endomorphisms compatible with all E -morphisms $E \rightarrow E$. More explicitly, we have

$$E' = C_{\text{End}_R(E)}(\text{End}_E(E))$$

and

$$\text{End}_E(E) = C_{\text{End}_R(E)}(E) = E^{op}$$

as E is unitary. Indeed, the E -endomorphisms are given by right multiplication by elements of E . Hence we also have

$$E' = C_{\text{End}_R(E)}(E^{op}) = E.$$

Hence in this case the functor $\mathcal{A} \rightarrow \mathcal{C}(\mathcal{A}, T)$ is the identity.

Lemma 7.3.16. Let \mathcal{A} be an abelian category. Let $\mathcal{A} \xrightarrow{T} R\text{-Mod}$ be a faithful exact R -linear functor into the category of finitely generated R -modules and let $\mathcal{A} \xrightarrow{\tilde{T}} \mathcal{C}(\mathcal{A}, T) \xrightarrow{f_T} R\text{-Mod}$ be the factorisation via the diagram category constructed in Proposition 7.2.5. For an object $p \in \mathcal{A}$ let $E(p) = \text{End}(T|_p)$.

Then:

1. There exists an object $X(p) \in \text{Ob}(\langle p \rangle)$ such that

$$\tilde{T}(X(p)) = E(p)$$

under the inclusion $E(p)\text{-Mod} \rightarrow \mathcal{C}(\mathcal{A}, T)$.

2. The object $X(p)$ has a right $E(p)$ -module structure in \mathcal{A}

$$E(p)^{op} \rightarrow \text{End}_{\mathcal{A}}(X(p))$$

such that the induced $E(p)$ -module structure on $\tilde{T}(X(p)) = E(p)$ is given by composition of endomorphisms.

3. There is an isomorphism

$$\tau : X(p) \otimes_{E(p)} \tilde{T}p \rightarrow p$$

which is natural in $f \in \text{End}_{\mathcal{A}}(p)$, i.e.,

$$\begin{array}{ccc} p & \xrightarrow{f} & p \\ \downarrow \tau & & \downarrow \tau \\ X(p) \otimes_{E(p)} \tilde{T}p & \xrightarrow{id \otimes \tilde{T}f} & X(p) \otimes_{E(p)} \tilde{T}p \end{array}$$

4. Let q be another object of \mathcal{A} . Then there is a natural map $X(p \oplus q) \rightarrow X(p)$ compatible with the operation of $E(p \oplus q) \rightarrow E(p)$.

An easier construction of $X(p)$ in the field case can be found in [DM82], the construction when R is a noetherian ring is due to Nori [Nor00].

Proof. We consider the object $\text{Hom}_R(Tp, p) \in \mathcal{A}$. Via the contravariant functor

$$\begin{array}{ccc} R\text{-Mod} & \xrightarrow{\text{Hom}_{(-), p}} & \mathcal{A} \\ Tp & \mapsto & \text{Hom}_R(Tp, p) \end{array}$$

of Proposition 7.3.10 it is a right $\text{End}_R(Tp)$ -module in \mathcal{A} which, after applying T , just becomes the usual right $\text{End}_R(Tp)$ -module $\text{Hom}_R(Tp, Tp)$. For each $\varphi \in \text{End}_R(Tp)$, we will also write $(-)\circ\varphi$ for the action on $\text{Hom}(Tp, p)$. By Lemma 7.3.12, the functors $\text{Hom}_R(Tp, -)$ and $- \otimes_R Tp$ are adjoint, so we obtain an evaluation map

$$\tilde{e}v : \text{Hom}_R(Tp, p) \otimes_R Tp \longrightarrow p$$

that becomes the usual evaluation in $R\text{-Mod}$ after applying T . Our aim is now to define $X(p)$ as a suitable subobject of $\text{Hom}_R(Tp, p) \in \mathcal{A}$. The structures on $X(p)$ will be induced from the structures on $\text{Hom}_R(Tp, p)$.

Let $M \in R\text{-Mod}$. We consider the functor

$$\begin{array}{ccc} \mathcal{A} & \xrightarrow{\text{Hom}_R(M, -)} & \mathcal{A} \\ p & \mapsto & \text{Hom}_R(M, p) \end{array}$$

$$\begin{array}{c}
\bigoplus_{i=1}^k (E(p) \otimes_R Tp) \xrightarrow{\Sigma} E(p) \otimes_R Tp \xrightarrow{\text{inc} \otimes \text{id}} \text{Hom}_R(Tp, Tp) \otimes_R Tp \xrightarrow{\text{ev}} Tp \\
\searrow \text{Coker}(\Sigma) \\
E(p) \otimes_{E(p)} \tilde{T}p
\end{array}$$

in $R\text{-Mod}$, where the composition of the horizontal maps becomes zero. Since T is faithful, the respective horizontal maps in \mathcal{A} are zero as well and induce a map

$$\tau : X(p) \otimes_{E(p)} Tp \longrightarrow p$$

that keeps the diagram commutative. By definition of Σ in Proposition 7.3.9, the respective map

$$\tilde{T}\tau : E(p) \otimes_{E(p)} \tilde{T}p \longrightarrow \tilde{T}p$$

becomes the natural evaluation isomorphism of E -modules. Since \tilde{T} is faithful, τ is an isomorphism as well.

Naturality in f holds since \tilde{T} is faithful and

$$\begin{array}{ccc}
\tilde{T}p & \xrightarrow{\tilde{T}f} & \tilde{T}p \\
\downarrow \tilde{T}\tau & & \downarrow \tilde{T}\tau \\
E(p) \otimes_{E(p)} \tilde{T}p & \xrightarrow{\text{id} \otimes \tilde{T}f} & E(p) \otimes_{E(p)} \tilde{T}p
\end{array}$$

commutes in $E(p)\text{-Mod}$.

Given the projection $p \oplus q \rightarrow p$, we have natural surjections $\text{End}_R(T(p \oplus q)) \rightarrow \text{End}_R(Tp)$ and $\text{Hom}(T(p \oplus q), p \oplus q) \rightarrow \text{Hom}(Tp, p)$. By construction, the induced maps $E(p \oplus q) \rightarrow E(p)$ and $X(p \oplus q) \rightarrow X(p)$ are compatible with the right module structure. \square

Definition 7.3.17. Let \mathcal{A} be an R -linear, abelian category and

$$\mathcal{A} \xrightarrow{T} R\text{-Mod}$$

be a faithful, exact, R -linear functor. Let p be an object of \mathcal{A} and $X(p)$ the right- $E(p)$ -module in \mathcal{A} constructed in Lemma 7.3.16. We denote by

$$i_p : E(p)\text{-Mod} \rightarrow \mathcal{A}$$

the functor $M \mapsto X(p) \otimes_{E(p)} M$.

Proposition 7.3.18. Let \mathcal{A} be an R -linear, abelian category and

$$\mathcal{A} \xrightarrow{T} R\text{-Mod}$$

be a faithful, exact, R -linear functor. Let

$$\mathcal{A} \xrightarrow{\tilde{T}} \mathcal{C}(\mathcal{A}, T) \xrightarrow{f_T} R\text{-Mod}$$

be the factorisation of T via its diagram category. Let p be an object of \mathcal{A} and i_p the functor of Definition 7.3.17. Then the composition

$$E(p)\text{-Mod} \xrightarrow{i_p} \mathcal{A} \xrightarrow{f_T} \mathcal{C}(\mathcal{A}, T)$$

agrees with the natural functor

$$\mathcal{C}(\langle p \rangle^{\text{psab}}, T) \rightarrow \mathcal{C}(\mathcal{A}, T).$$

Proof. The functor $i_p : E(p)\text{-Mod} \rightarrow \mathcal{A}$ is faithful and exact because this can be tested after applying T . By Lemma 7.2.2 it also induces a functor

$$\mathcal{C}(E(p)\text{-Mod}, T \circ i_p) \rightarrow \mathcal{C}(\mathcal{A}, T).$$

By Example 7.3.15 the category on the left-hand side is nothing but the category $E(p)\text{-Mod}$ itself. Moreover, the image of $E(p)\text{-Mod}$ inside \mathcal{A} is an (in general non-full) exact abelian subcategory containing $\langle p \rangle^{\text{psab}}$. The latter also has diagram category $E(p)\text{-Mod}$ by Lemma 7.3.14. This finishes the proof. \square

Proof of Theorem 7.1.20. Let \mathcal{A} be an R -linear abelian category and $T : \mathcal{A} \rightarrow R\text{-Mod}$ faithful and exact. We want to show that $\mathcal{C}(\mathcal{A}, T)$ is equivalent to \mathcal{A} . We write \mathcal{A} as the union of its system of subcategories of the form $\langle p \rangle^{\text{psab}}$ running through $p \in \mathcal{A}$. The system is filtered with respect to the inclusions induced by $p \rightarrow p \oplus q$ for all objects p, q .

Recall that $E(p) = \text{End}(T|_{\{p\}})$. Note that

$$E(p)\text{-Mod} = \mathcal{C}(\{p\}, T|_{\{p\}}) = \mathcal{C}(\langle p \rangle^{\text{psab}}, T)$$

by Lemma 7.3.14.

On the other hand, by definition,

$$\mathcal{C}(\mathcal{A}, T) = 2\text{-colim}_{F \subset \text{Ob}(\mathcal{A})} \text{End}(T|_F)\text{-Mod}$$

with F ranging over the system of full subcategories of \mathcal{A} that contain only a finite number of objects. As $\langle F \rangle^{\text{psab}} = \langle \bigoplus_{p \in F} p \rangle^{\text{psab}}$, we may as well use the same direct system as for \mathcal{A} itself.

By Definition 7.3.17, we have a functor

$$i_p : E(p)\text{-Mod} = \mathcal{C}(\langle p \rangle^{\text{psab}}, T) \rightarrow \mathcal{A}.$$

By Lemma 7.3.16 4, they are compatible in the direct sum, hence we get a faithful exact functor

$$\mathcal{C}(\mathcal{A}, T) \rightarrow \mathcal{A}.$$

By Proposition 7.3.18, the composition with the natural functor to \mathcal{A} is the identity. Hence

$$\mathcal{A} \rightarrow \mathcal{C}(\mathcal{A}, T)$$

is essentially surjective and full. It is faithful because T is faithful. Hence it is an equivalence of categories. \square

To conclude, we formulate the consequences of the above in the special case $\mathcal{A} = \langle p \rangle$.

Corollary 7.3.19. *Let $\mathcal{A} = \langle p \rangle$ be an R -linear abelian category and $T : \mathcal{A} \rightarrow R\text{-Mod}$ faithful and exact. Then*

$$\langle p \rangle \cong 2\text{-colim}_E E\text{-Mod},$$

where E runs through a suitable system of subalgebras of $E(p)$. If R is a field, then we even have an equivalence

$$\langle p \rangle \cong E\text{-Mod}$$

where $E \subset E(p)$ is the subalgebra of endomorphisms respecting all subquotients q of p^n for all n and commuting with all their endomorphisms.

Proof. By the case of a general abelian category, we have

$$\mathcal{C}(\langle p \rangle, T) = 2\text{-colim}_F E(F)\text{-Mod},$$

where F is a finite set of objects containing p and

$$E(F) = E\left(\bigoplus_{q \in F} q\right).$$

If $\mathcal{A} = \langle p \rangle$, every object q of $\langle p \rangle$ is a subquotient of some p^n . Let $(\alpha_q)_q \in \text{End}(T)$. We have already seen that α_{p^n} is determined by α_p . Now let $q' \subset p^n$. Then $\alpha_{q'}$ is determined by α_{p^n} and by compatibility with the inclusion. Finally, let q be a quotient of q' . Then α_q is determined by $\alpha_{q'}$ and by compatibility with the projection. This means

$$E(p) \supset E(F)$$

if we choose F containing p and with q , in addition, a subobject $q' \subset p^n$ surjecting to q . This proves the general assertion for noetherian rings.

The system of such F is filtered by inclusion. We have inside $E(p)$

$$\mathrm{End}(T|_{\langle p \rangle}) = \bigcap_F \mathrm{End}(T|_F).$$

If R is a field, then $E(p)$ is a finite-dimensional vector space and the system of $\mathrm{End}(T|_F)$ becomes stable. This intersection is E . \square

Remark 7.3.20. In the field case, analogous considerations to those in this section can be found in [DM82, Lemma 2.13]. However, the proof is in fact different. They are in the case of a field R and implicitly make use of the last identity of the above corollary. Their argument fails in the case of a noetherian ring.

The following example shows that the above description is optimal in the case of rings, even Dedekind rings and Tp free.

Example 7.3.21. Let $R = \mathbb{Z}$. For $n \in \mathbb{N}$ we choose the \mathbb{Z} -module $A_n = \mathbb{Z} + \mathbb{Z}n\sqrt{3}$ and define $\mathcal{A} = 2\text{-colim}_n A_n\text{-Mod}$. The same arguments can also be made for the systems of orders of any number field different from \mathbb{Q} . Let T be the forgetful functor to $\mathbb{Z}\text{-Mod}$. Let $p = A_1$. We have

$$\mathrm{End}_{\mathcal{A}}(p) = A_1$$

because any A_n -linear endomorphism is automatically A_1 -linear. Hence $E(p) = A_1$. On the other hand, the category $\langle p \rangle$ contains the objects

$$q_n = p/np = (\mathbb{Z} + \sqrt{3}\mathbb{Z})/n(\mathbb{Z} + \sqrt{3}n\mathbb{Z}).$$

We have

$$\mathrm{End}_{A_1}(q_n) = A_1/nA_1.$$

On the other hand, the ring A_n acts via the quotient $\mathbb{Z}/n\mathbb{Z}$ on q_n , hence

$$\mathrm{End}_{\mathcal{A}}(q_n) = M_2(\mathbb{Z}/n\mathbb{Z}).$$

This shows that $E(p)\text{-Mod}$ is a strictly non-full abelian subcategory of $\langle p \rangle$. Moreover, consider the A_n -linear map

$$\begin{aligned} \pi : q_n &\rightarrow q_n \\ a + b\sqrt{3} &\mapsto b\sqrt{3} \pmod{n}. \end{aligned}$$

The kernel of $p \rightarrow q_n \xrightarrow{\pi} q_n$ is A_n viewed as an A_n -module. Hence it is also in $\langle p \rangle$. This implies $\langle p \rangle = \mathcal{A}$. Finally, it is not equal to $A_n\text{-Mod}$ for any n .

7.3.3 Examples and applications

We work out a couple of explicit examples in order to demonstrate the strength of Theorem 7.1.20. We also use the arguments of the proof to deduce an additional property of the diagram category as a first step towards its universal property.

Throughout let R be a noetherian unital ring.

Example 7.3.22. Let $T : R\text{-Mod} \rightarrow R\text{-Mod}$ be the identity functor viewed as a representation. The assumptions of Theorem 7.1.20 are satisfied and we get an equivalence

$$\mathcal{C}(R\text{-Mod}, T) \longrightarrow R\text{-Mod}.$$

Note that $R\text{-Mod}$ is also generated by the object R^n for any fixed n . It is a projective generator. Hence, by Lemma 7.3.14, $\mathcal{C}(R\text{-Mod}, T) = E\text{-Mod}$ with $E = \text{End}_R(T|_{R^n})$. By definition, E consists of those elements of $\text{End}_R(R^n)$ which commute with all elements of $\text{End}_{\mathcal{A}}(R^n)$, i.e., E is the center of the matrix algebra, which is R .

This can be made more interesting by playing with the representation.

Example 7.3.23 (Morita equivalence). Let R be a noetherian commutative unital ring, $\mathcal{A} = R\text{-Mod}$. Let P be a faithfully flat finitely generated R -module and

$$T : R\text{-Mod} \longrightarrow R\text{-Mod}, \quad M \mapsto M \otimes_R P.$$

It is faithful and exact, hence the assumptions of Theorem 7.1.20 are satisfied and we get an equivalence

$$\mathcal{C}(R\text{-Mod}, T) \longrightarrow R\text{-Mod}.$$

Note that $\mathcal{A} = \langle R \rangle$ has a projective generator. By Lemma 7.3.14 we have $\mathcal{C}(R\text{-Mod}, T) = \text{End}_R(P)\text{-Mod}$. Hence we have shown that

$$\text{End}_R(P)\text{-Mod} \rightarrow R\text{-Mod}$$

is an equivalence of categories. This is a case of Morita equivalence of categories of modules.

We deduce another consequence of the explicit description of $\mathcal{C}(D, T)$.

Proposition 7.3.24. *Let D be a diagram and $T : D \rightarrow R\text{-Mod}$ a representation. Let*

$$D \xrightarrow{\tilde{T}} \mathcal{C}(D, T) \xrightarrow{f_T} R\text{-Mod}$$

be its factorisation. Then the category $\mathcal{C}(D, T)$ agrees with its smallest full abelian subcategory containing the image \tilde{T} and on which f_T is exact.

Proof. It suffices to consider the case when D is finite. Let $X = \bigoplus_{p \in D} Tp$ and $\mathbb{E} = \text{End}_R(X)$. Let $S \subset \mathbb{E}$ be the R -subalgebra generated by Te for $e \in E(D)$ and the projectors $p_p : X \rightarrow T(p)$. Then

$$E = \text{End}(T) = C_{\mathbb{E}}(S)$$

is the centraliser of S in \mathbb{E} . (The endomorphisms commuting with the projectors are those respecting the decomposition. By definition, $\text{End}(T)$ consists of those endomorphisms of the summands commuting with all Te .)

By construction $\mathcal{C}(D, T) = E\text{-Mod}$. We claim that it is equal to the full abelian subcategory

$$\mathcal{A} = \langle \tilde{X} \rangle$$

containing $\tilde{X} = \bigoplus_{p \in D} \tilde{T}p$ such that f_T is exact on \mathcal{A} . The category has a faithful exact representation by $f_T|_{\mathcal{A}}$. Note that $f_T(\tilde{X}) = X$. We compute

$$E(\tilde{X}) := \text{End}(f_T|_{\{\tilde{X}\}}).$$

It is given by elements of $\mathbb{E} = \text{End}_R(X)$ commuting with $\text{End}_{\mathcal{A}}(\tilde{X})$. Note that

$$\text{End}_{\mathcal{A}}(\tilde{X}) = \text{End}_E(X) = C_{\mathbb{E}}(E)$$

and hence

$$E(\tilde{X}) = C_{\mathbb{E}}(C_{\mathbb{E}}(E)) = C_{\mathbb{E}}(C_{\mathbb{E}}(C_{\mathbb{E}}(S))) = C_{\mathbb{E}}(S) = E$$

because a triple centraliser equals the simple centraliser. Hence by Proposition 7.3.18, the functor

$$i_{\tilde{X}} : E\text{-Mod} \rightarrow \mathcal{A}$$

of Definition 7.3.17 is quasi-inverse to the inclusion $\mathcal{A} \rightarrow E\text{-Mod}$. \square

Remark 7.3.25. This is a direct proof of Proposition 7.1.16.

7.4 Universal property of the diagram category

At the end of this section we will be able to establish the universal property of the diagram category.

Let $T : D \rightarrow R\text{-Mod}$ be a diagram and

$$D \xrightarrow{\tilde{T}} \mathcal{C}(D, T) \xrightarrow{f_T} R\text{-Mod}$$

the factorisation of T via its diagram category. Let \mathcal{A} be another R -linear abelian category, $F : D \rightarrow \mathcal{A}$ a representation, and $T_{\mathcal{A}} : \mathcal{A} \rightarrow R\text{-Mod}$ a

faithful, exact, R -linear functor into the category of finitely generated R -modules such that $f \circ F = T$.

Our aim is to deduce that there exists — uniquely up to unique isomorphism — an R -linear exact faithful functor

$$L(F) : \mathcal{C}(D, T) \rightarrow \mathcal{A},$$

making the following diagram commute:

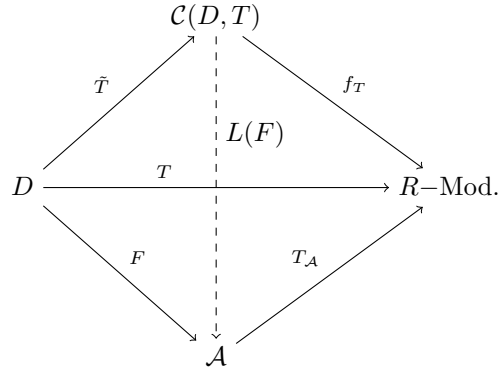

Proposition 7.4.1. *There is a functor $L(F)$ making the diagram commute.*

Proof. We can regard \mathcal{A} as a diagram and obtain a representation

$$\mathcal{A} \xrightarrow{T_A} R\text{-Mod},$$

which factorises via its diagram category

$$\mathcal{A} \xrightarrow{\tilde{T}_A} \mathcal{C}(\mathcal{A}, T_A) \xrightarrow{f_{T_A}} R\text{-Mod}.$$

We obtain the following commutative diagram

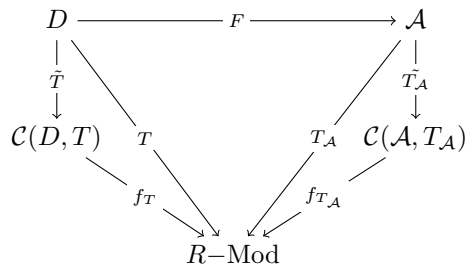

By functoriality of the diagram category (see Proposition 7.2.6) there exists an R -linear faithful exact functor \mathcal{F} such that the following diagram commutes:

$$\begin{array}{ccc}
D & \xrightarrow{\quad F \quad} & \mathcal{A} \\
\downarrow \tilde{T} & & \downarrow \tilde{T}_{\mathcal{A}} \\
\mathcal{C}(D, T) & \xrightarrow{\quad \mathcal{F} \quad} & \mathcal{C}(\mathcal{A}, T_{\mathcal{A}}) \\
& \searrow f_T & \swarrow f_{T_{\mathcal{A}}} \\
& R\text{-Mod} &
\end{array}$$

Since \mathcal{A} is R -linear and abelian, and $T_{\mathcal{A}}$ is faithful, exact and R -linear, we know by Proposition 7.1.20 that $\tilde{T}_{\mathcal{A}}$ is an equivalence of categories. The functor

$$L(F) : \mathcal{C}(D, T) \rightarrow \mathcal{A}$$

is given by the composition of \mathcal{F} with the inverse of $\tilde{T}_{\mathcal{A}}$. Since an equivalence of R -linear categories is exact, faithful and R -linear, so is $L(F)$, as it is the composition of such functors. \square

Proposition 7.4.2. *The functor $L(F)$ is unique up to unique isomorphism of exact additive functors.*

Proof. Let L' be another functor satisfying the condition in the diagram. Let \mathcal{C}' be the subcategory of $\mathcal{C}(D, T)$ on which $L' = L(F)$. We claim that the inclusion is an equivalence of categories. Without loss of generality, we may assume that D is finite.

Note that the subcategory is full because $T_{\mathcal{A}} : \mathcal{A} \rightarrow R\text{-Mod}$ is faithful. It contains all objects of the form $\tilde{T}p$ for $p \in D$. As the functors are additive, this implies that they also have to agree (up to unique isomorphism of additive functors) on finite direct sums of objects. As the functors are exact, they also have to agree on all kernels and cokernels. Hence \mathcal{C}' is the full abelian subcategory of $\mathcal{C}(D, T)$ generated by $\tilde{T}(D)$. By Proposition 7.3.24 this is all of $\mathcal{C}(D, T)$. \square

Proof of Theorem 7.1.13. Let $T : D \rightarrow R\text{-Mod}$ be a representation and $T_{\mathcal{A}} = f : \mathcal{A} \rightarrow R\text{-Mod}$, $F : D \rightarrow \mathcal{A}$ be as in the statement. By Proposition 7.4.1 the functor $L(F)$ exists. It is unique up to unique isomorphism by Proposition 7.4.2. Hence $\mathcal{C}(D, T)$ satisfies the universal property of Theorem 7.1.13.

Let \mathcal{C} be another category satisfying the universal property. By the universal property for $\mathcal{C}(D, T)$ and the representation of D in \mathcal{C} , we get a functor $\Psi : \mathcal{C}(D, T) \rightarrow \mathcal{C}$. By interchanging their roles, we obtain a functor Ψ' in the opposite direction. Their composition $\Psi' \circ \Psi$ satisfies the universal property for $\mathcal{C}(D, T)$ and the representation \tilde{T} . By the uniqueness part, it is isomorphic to the identity functor. The same argument also applies to $\Psi \circ \Psi'$. Hence Ψ is an equivalence of categories.

Functoriality of $\mathcal{C}(D, T)$ in D is Lemma 7.2.6. \square

The generalised universal property follows by a trick.

Proof of Corollary 7.1.15. Let $T : D \rightarrow R\text{-Mod}$, $f : \mathcal{A} \rightarrow R\text{-Mod}$ and $F : D \rightarrow \mathcal{A}$ be as in the corollary. Let S be a faithfully flat R -algebra and

$$\phi : T_S \rightarrow (f \circ F)_S$$

an isomorphism of representations into $S\text{-Mod}$. We first prove the existence of $L(F)$.

Let \mathcal{A}' be the category with objects of the form (V_1, V_2, ψ) where $V_1 \in R\text{-Mod}$, $V_2 \in \mathcal{A}$ and $\psi : V_1 \otimes_R S \rightarrow f(V_2) \otimes_R S$ an isomorphism. The morphisms in $R\text{-Mod}$ and \mathcal{A} such that the obvious diagram commutes. This category is abelian because S is flat over R . Kernels and cokernels are taken componentwise. Let $f' : \mathcal{A}' \rightarrow R\text{-Mod}$ be the projection to the first component. It is faithful and exact because S is faithfully flat over R .

The data T , F and ϕ define a representation $F' : D \rightarrow \mathcal{A}'$ compatible with T . By the universal property of Theorem 7.1.13, we obtain a factorisation

$$T : D \xrightarrow{\tilde{T}} \mathcal{C}(D, T) \xrightarrow{L(F')} \mathcal{A}' \rightarrow R\text{-Mod}.$$

We define $L(F)$ as the composition of $L(F')$ with the projection to the second component. For $X \in \mathcal{C}(D, T)$, the object $L(F')(X) \in \mathcal{A}'$ is by definition a triple $(f_T(X), L(F')(X), \phi_X)$. Assigning the isomorphism ϕ_X to X defines the isomorphism of functors on $\mathcal{C}(D, T)$

$$\tilde{\phi} : (f_T)_S \rightarrow f_S \circ L(F).$$

We now want to show uniqueness. Let $(L', \tilde{\phi}')$ be another candidate for $(L(F), \tilde{\phi})$. Then

$$X \mapsto (f_T(X), L'(X), \tilde{\phi}'_X)$$

is another candidate for $L(F')$. By the uniqueness part of the universal property it agrees with $L(F')$ up to isomorphism. This induces the isomorphism $(L(F), \tilde{\phi}) \rightarrow (L', \tilde{\phi}')$. Any such isomorphism has to agree with the one for $L(F')$, hence it is unique. \square

7.5 The diagram category as a category of comodules

Under more restrictive assumptions on R and T , we can give a description of the diagram category as a category of comodules, see Theorem 7.1.12.

7.5.1 Preliminary discussion

In [DM82] Deligne and Milne note that if R is a field, E a finite-dimensional R -algebra, and V an E -module that is finite-dimensional as an R -vector space then V has a natural structure as a comodule over the coalgebra $E^\vee := \text{Hom}_R(E, R)$. For an algebra E finitely generated as an R -module over an arbitrary noetherian ring R , the R -dual E^\vee does not even necessarily carry a natural structure of an R -coalgebra. The problem is that the map dual to the algebra multiplication

$$E^\vee \xrightarrow{\mu^\vee} (E \otimes_R E)^\vee$$

does not generally define a comultiplication because the canonical map

$$\rho : E^\vee \otimes_R E^\vee \rightarrow \text{Hom}(E, E^\vee) \cong (E \otimes_R E)^\vee$$

fails to be an isomorphism in general. In this chapter, we will see that this isomorphism holds true for the R -algebras $\text{End}(T|_F)$ if we assume that R is a Dedekind domain or field. We will then show that via

$$\begin{aligned} \mathcal{C}(D, T) &= 2\text{-colim}_{F \subset D} (\text{End}(T|_F)\text{-Mod}) \\ &\cong 2\text{-colim}_{F \subset D} (\text{End}(T|_F)^\vee\text{-Comod}) \cong \left(\text{colim}_{F \subset D} \text{End}(T|_F)^\vee \right)\text{-Comod} \end{aligned}$$

we can view the diagram category $\mathcal{C}(D, T)$ as the category of finitely generated comodules over the coalgebra $2\text{-colim}_{F \subset D} \text{End}(T|_F)^\vee$.

Remark 7.5.1. Note that the category of comodules over an arbitrary coalgebra C is not abelian in general, since the tensor product $X \otimes_R -$ is right exact, but in general not left exact. If C is flat as an R -algebra (e.g. free), then the category of C -comodules is abelian [MM65, pg. 219].

7.5.2 Coalgebras and comodules

Let R be a noetherian ring with unit.

Proposition 7.5.2. *Let E be an R -algebra which is finitely generated as an R -module. Then the canonical map*

$$\begin{aligned} \rho : E^\vee \otimes_R M &\rightarrow \text{Hom}(E, M) \\ \varphi \otimes m &\mapsto (n \mapsto \varphi(n) \cdot m) \end{aligned}$$

becomes an isomorphism for all R -modules M if and only if E is projective.

Proof. [Str07, Proposition 5.2] \square

Remark 7.5.3. Throughout we are working with the following convention: if V, W are projective R -modules of finite rank, then we identify

$$(V \otimes_R W)^\vee = V^\vee \otimes W^\vee.$$

Lemma 7.5.4. *Let E be an R -algebra which is finitely generated and projective as an R -module.*

1. *The R -dual module E^\vee carries a natural structure of a counital coalgebra.*
2. *Any left E -module that is finitely generated as an R -module carries a natural structure as a right E^\vee -comodule.*
3. *We obtain an equivalence of categories between the category of finitely generated left E -modules and the category of finitely generated right E^\vee -comodules.*

Proof. By repeated application of Proposition 7.5.2, this becomes a straightforward calculation. We will sketch the main steps of the proof.

1. If we dualise the associativity constraint of E we obtain a commutative diagram of the form

$$\begin{array}{ccc} (E \otimes_R E \otimes_R E)^\vee & \xleftarrow{(\mu \otimes id)^\vee} & (E \otimes_R E)^\vee \\ (id \otimes \mu)^\vee \uparrow & & \uparrow \mu^\vee \\ (E \otimes_R E)^\vee & \xleftarrow{\mu^\vee} & E^\vee. \end{array}$$

By the use of the isomorphism in Proposition 7.5.2 and Hom-Tensor adjunction we obtain the commutative diagram

$$\begin{array}{ccc} E^\vee \otimes_R E^\vee \otimes_R E^\vee & \xleftarrow{\mu^* \otimes id^*} & E^\vee \otimes_R E^\vee \\ id^* \otimes \mu^* \uparrow & & \uparrow \mu^* \\ E^\vee \otimes_R E^\vee & \xleftarrow{\mu^*} & E^\vee, \end{array}$$

which induces a cocommutative comultiplication on E^\vee . Similarly we obtain the counit diagram, so E^\vee naturally gets a coalgebra structure. We make this explicit for later use. Let e_i for $i \in I$ be a basis of E . Then

$$e_i e_j = \sum_k a_{ij}^k e_k$$

with $a_{ij}^k \in R$. We denote by e_k^\vee the dual basis of E^\vee . Then

$$\mu^*(e_k^\vee) = \sum_{i,j} a_{ij}^k e_i^\vee \otimes e_j^\vee.$$

2. Let M be an E -module. We use Proposition 7.5.2 and Hom-Tensor adjunction to see that the E -multiplication induces a well-defined E^\vee -comultiplication

$$\hat{m} : M \rightarrow \mathrm{Hom}_R(E, M) \cong M \otimes_R E^\vee.$$

In the basis e_i for $i \in I$ of E , it is given by

$$m \mapsto \sum_i e_i m \otimes e_i^\vee.$$

We need to check that the following diagram commutes:

$$\begin{array}{ccc} M & \xrightarrow{\hat{m}} & M \otimes_R E^\vee \\ \downarrow \hat{m} & & \downarrow \hat{m} \otimes \mathrm{id} \\ M \otimes_R E^\vee & \xrightarrow{\mathrm{id} \otimes \mu^*} & M \otimes_R E^\vee \otimes_R E^\vee \end{array}$$

Indeed, the composition via the upper right corner is given by

$$m \mapsto \sum_j e_j m \otimes e_j^\vee \mapsto \sum_{i,j} e_i e_j m \otimes e_i^\vee \otimes e_j^\vee = \sum_{ijk} a_{ij}^k e_k m \otimes e_i^\vee \otimes e_j^\vee.$$

On the other hand, the composition via the lower left corner is given by

$$m \mapsto \sum_k e_k m \otimes e_k^\vee \mapsto \sum_k e_k m \otimes \mu^*(e_k^\vee) = \sum_{kij} e_k m \otimes a_{ij}^k e_i^\vee \otimes e_j^\vee.$$

3. For any homomorphism $f : M \rightarrow N$ of left E -modules, the commutative diagram

$$\begin{array}{ccc} M & \xrightarrow{f} & N \\ \uparrow m & & \uparrow m \\ E \otimes_R M & \xrightarrow{\mathrm{id} \otimes f} & E \otimes_R N \end{array}$$

induces by adjunction a commutative diagram

$$\begin{array}{ccc}
M \otimes_R E^\vee & \xrightarrow{id \otimes f} & N \otimes_R E^\vee, \\
\hat{m} \uparrow & & \uparrow \hat{m} \\
M & \xrightarrow{f} & N
\end{array}$$

thus f is a homomorphism of right E^\vee -comodules.

4. Conversely, we can dualise the E^\vee -comodule structure to obtain an $(E^\vee)^\vee = E$ -module structure. The two constructions are inverse to each other.

□

Remark 7.5.5. If R is a field, then every $M \in E\text{-Mod}$ is free over R . By passing to the dual of the structure map, we define a left E^\vee -comodule structure on M^\vee . Both the right comultiplication on M and the left comultiplication on M^\vee are equivalent to the data of a morphism

$$M \otimes_R M^\vee \rightarrow E^\vee.$$

This allows us to pass directly from one to the other. We call M^\vee the *contragredient* comodule to the comodule M .

Definition 7.5.6. Let A be a coalgebra over R . Then we denote by $A\text{-Comod}$ the category of right comodules over A that are finitely generated as R -modules.

Recall that $R\text{-Proj}$ denotes the category of finitely generated projective R -modules.

Corollary 7.5.7. Let R be a field or Dedekind domain, D a diagram and

$$T : D \longrightarrow R\text{-Proj}$$

a representation. Set

$$A(D, T) := \varinjlim_{\substack{F \subset D \\ \text{finite}}} \text{End}(T|_F)^\vee.$$

Then $A(D, T)$ has the structure of a coalgebra and the diagram category of T is the abelian category $A(D, T)\text{-Comod}$.

Proof. For any finite subset $F \subset D$ the algebra $\text{End}(T|_F)$ is a submodule of the finitely generated projective R -module $\prod_{p \in F} \text{End}(Tp)$. Since R is a field or Dedekind domain, for a finitely generated module to be projective is equivalent to being torsion-free. Hence the submodule $\text{End}(T|_F)$ is also finitely generated and torsion-free, or equivalently, projective. By the previous lemma, $\text{End}(T|_F)^\vee$ is an R -coalgebra and $\text{End}(T|_F)\text{-Mod} \cong \text{End}(T|_F)^\vee\text{-Comod}$.

From now on, we denote $\text{End}(T|_F)^\vee$ by $A(F, T)$. They obviously form a direct system for $F' \subset F$ finite subdiagrams of D . Taking limits over the direct system of finite subdiagrams as in Definition 7.1.10, we obtain

$$\mathcal{C}(D, T) := 2\text{-colim}_{\substack{F \subset D \\ \text{finite}}} \text{End}(T|_F)\text{-Mod} = 2\text{-colim}_{\substack{F \subset D \\ \text{finite}}} A(F, T)\text{-Comod}.$$

Since the category of coalgebras is cocomplete, $A(D, T) = \varinjlim_{F \subset D} A(F, T)$ is a coalgebra as well.

We now need to show that the categories $2\text{-colim}_{\substack{F \subset D \\ \text{finite}}} (A(F, T)\text{-Comod})$ and $A(D, T)\text{-Comod}$ are equivalent. For any finite F the canonical map $A(F, T) \rightarrow A(D, T)$ via restriction of scalars induces a functor

$$\phi_F : A(F, T)\text{-Comod} \rightarrow A(D, T)\text{-Comod}$$

and therefore by the universal property a unique functor

$$u : \left(\varinjlim_{F \subset D} A(F, T) \right)\text{-Comod} \rightarrow A(D, T)\text{-Comod}$$

such that for all finite $F', F'' \subset D$ with $F' \subset F''$ and the canonical functors

$$\psi_F : A(F', T)\text{-Comod} \rightarrow \left(\varinjlim_{F \subset D} A(F, T) \right)\text{-Comod}$$

the following diagram commutes:

$$\begin{array}{ccc} A(F', T)\text{-Comod} & \xrightarrow{\phi_{F'F''}} & A(F'', T)\text{-Comod} \\ & \searrow \psi_{F'} & \swarrow \psi_{F''} \\ & 2\text{-colim}_{F \subset D} (A(F, T)\text{-Comod}) & \\ & \downarrow \exists! u & \\ & A(D, T)\text{-Comod} & \end{array}$$

$\phi_{F'}$ (left arrow), $\phi_{F''}$ (right arrow)

We construct an inverse functor of u : let M be an $A(D, T)$ -comodule and

$$m : M \rightarrow M \otimes_R A(D, T)$$

be the comultiplication. Let $M = \langle x_1, \dots, x_n \rangle_R$. Then $m(x_i) = \sum_{k=1}^n a_{ki} \otimes x_k$ for certain $a_{ki} \in A(D, T)$. For every a_{ki} there is a finite subdiagram F such that a_{ki} is represented by an element of $A(F, T)$. By taking the union

of these finitely many F , we can assume that all a_{ki} are contained in one coalgebra $A(F, T)$. Since x_1, \dots, x_n generate M as an R -module, m defines a comultiplication

$$\tilde{m} : M \rightarrow M \otimes_R A(F, T).$$

So M is an $A(F, T)$ -comodule in a natural way, thus via ψ_F an object of $2\text{-colim}_I(A_i\text{-Comod})$. \square

We also need to understand the behaviour of $A(D, T)$ under base change.

Lemma 7.5.8 (Base change). *Let R be a field or a Dedekind domain and $T : D \rightarrow R\text{-Proj}$ a representation. Let $R \rightarrow S$ be flat. Then*

$$A(D, T_S) = A(D, T) \otimes_R S.$$

Proof. Let $F \subset D$ be a finite subdiagram. Recall that

$$A(F, T) = \text{Hom}_R(\text{End}(T|_F), R).$$

Both R and $\text{End}_R(T|_F)$ are projective because R is a field or a Dedekind domain. Hence by Lemma 7.2.2

$$\begin{aligned} \text{Hom}_R(\text{End}_R(T|_F), R) \otimes_R S &\cong \text{Hom}_S(\text{End}_R(T|_F) \otimes_R S, S) \\ &\cong \text{Hom}_S(\text{End}_S((T_S)|_F), S). \end{aligned}$$

This is nothing but $A(F, T_S)$. Tensor products commute with direct limits, hence the statement for $A(D, T)$ follows immediately. \square

Properties of functors between abelian categories translate into properties of morphisms of coalgebras.

Proposition 7.5.9. *Let k be a field. Let \mathcal{B} be an abelian category and $T : \mathcal{B} \rightarrow k\text{-Mod}$ a faithful exact functor. Let $\mathcal{A} \subset \mathcal{B}$ be a full abelian subcategory closed under subquotients. Then the induced morphism of coalgebras $A(\mathcal{A}, T|_{\mathcal{A}}) \rightarrow A(\mathcal{B}, T)$ is injective.*

Proof. We abbreviate $A = A(\mathcal{B}, T)$, $A' = A(\mathcal{A}, T|_{\mathcal{A}})$. By Theorem 7.1.20, we have without loss of generality

$$\mathcal{A} = A'\text{-Comod}, \quad \mathcal{B} = A\text{-Comod}.$$

The inclusion corresponds to a coalgebra homomorphism $A' \rightarrow A$. It turns A' into an A -comodule. Let B be the image of A' in A . As the category of A -comodules is abelian, this implies that B is an A -comodule as well. By assumption, the category \mathcal{A} is closed under subobjects in \mathcal{B} , hence B is even an A' -comodule. The counit $A \rightarrow k$ defines a map $B \rightarrow k$. It is compatible with the counit of A' because the homomorphism $A' \rightarrow A$ is counital. Using this map, we obtain

$$B \rightarrow B \otimes A' \rightarrow A'$$

compatible with the identity map

$$A' \rightarrow A' \otimes A \rightarrow A'.$$

This means that $B \rightarrow A'$ is a section of $A' \rightarrow B$, i.e., $A' = B$ and $A' \rightarrow A$ is injective. \square

Remark 7.5.10. Arguments with comodules can be confusing. The dual argument for modules is the following: let $E \rightarrow E'$ be an algebraic homomorphism such that the induced functor

$$\mathcal{A} = E'\text{-Mod} \rightarrow \mathcal{B} = E\text{-Mod}$$

is the inclusion of a full subcategory closed under subquotients. We want to show that $E \rightarrow E'$ is surjective. Let M be the image of E in E' . It is an E -submodule of the E' -module E' . By assumption, the category of E' -modules is closed under subquotients in the category of E -modules. Hence M is even a E' -submodule of E' . The homomorphism $E \rightarrow E'$ is unital, hence $1 \in M$. This implies that $M = E'$.

Chapter 8

More on diagrams

The aim of this chapter is to introduce and study additional structures on a diagram such that its diagram category becomes a rigid tensor category. The assumptions are tailored to the application to Nori motives.

The first step is to add a proto-multiplication on the diagram which turns the diagram category into a tensor category and the diagram coalgebra into a bialgebra. A particularly puzzling and subtle question is how the graded commutativity of the Künneth formula is dealt with.

We then introduce a notion of localisation of diagrams which corresponds to the localisation of the diagram category with respect to some object or equivalently the localisation of the algebra with respect to an element.

Following Nori, we next give a rigidity criterion for tensor categories.

Finally, we systematically study the dependence of the diagram category on the choice of representation. This will be applied in Chapter 13 on formal periods.

We continue to work in the setting of Chapter 7.

8.1 Multiplicative structure

Let R be a fixed noetherian unital commutative ring.

Recall that $R\text{-Proj}$ is the category of finitely generated projective R -modules. We only consider representations $T : D \rightarrow R\text{-Proj}$ where D is a diagram with identities, see Definition 7.1.1.

Definition 8.1.1. Let D_1, D_2 be diagrams with identities. Then $D_1 \times D_2$ is defined as the diagram with vertices of the form (v, w) for v a vertex of D_1 , w a vertex of D_2 , and with edges of the form (α, id) and (id, β) for α an edge of D_1 and β an edge of D_2 and with $\text{id} = (\text{id}, \text{id})$.

Remark 8.1.2. Levine in [Lev05, p. 466] seems to define $D_1 \times D_2$ by taking the product of the graphs in the ordinary sense. He claims (in the notation

of loc. cit.) a map of diagrams

$$H_*\text{Sch}' \times H_*\text{Sch}' \rightarrow H_*\text{Sch}'.$$

It is not clear to us how this is defined on general pairs of edges. If α, β are edges corresponding to boundary maps and hence lower the degree by 1, then we would expect $\alpha \times \beta$ to lower the degree by 2. However, there are no such edges in $H_*\text{Sch}'$.

Our restricted version of products of diagrams is enough to get the implications we want.

In order to control signs in the Künneth formula, we need to work in a graded commutative setting.

Definition 8.1.3. A *graded diagram* is a diagram D with identities together with a map

$$|\cdot| : \{\text{vertices of } D\} \rightarrow \mathbb{Z}/2\mathbb{Z}.$$

For an edge $\gamma : v \rightarrow v'$ we put $|\gamma| = |v| - |v'|$. If D is a graded diagram, $D \times D$ is equipped with the grading $|(v, w)| = |v| + |w|$.

A *commutative product structure* on a graded diagram D is a map of graded diagrams

$$\times : D \times D \rightarrow D$$

together with choices of edges

$$\begin{aligned} \alpha_{v,w} &: v \times w \rightarrow w \times v \\ \beta_{v,w,u} &: v \times (w \times u) \rightarrow (v \times w) \times u \\ \beta'_{v,w,u} &: (v \times w) \times u \rightarrow v \times (w \times u) \end{aligned}$$

for all vertices v, w, u of D .

A *graded multiplicative representation* T of a graded diagram with commutative product structure is a representation of T in $R\text{-Proj}$ together with a choice of isomorphism

$$\tau_{(v,w)} : T(v \times w) \rightarrow T(v) \otimes T(w)$$

such that:

1. The composition

$$T(v) \otimes T(w) \xrightarrow{\tau_{(v,w)}^{-1}} T(v \times w) \xrightarrow{T(\alpha_{v,w})} T(w \times v) \xrightarrow{\tau_{(w,v)}} T(w) \otimes T(v)$$

is $(-1)^{|v||w|}$ times the natural map of R -modules.

2. If $\gamma : v \rightarrow v'$ is an edge, then the diagram

$$\begin{array}{ccc}
T(v \times w) & \xrightarrow{T(\gamma \times \text{id})} & T(v' \times w) \\
\tau \downarrow & & \downarrow \tau \\
T(v) \otimes T(w) & \xrightarrow{(-1)^{|\gamma||w|} T(\gamma) \otimes \text{id}} & T(v') \otimes T(w)
\end{array}$$

commutes.

3. If $\gamma : v \rightarrow v'$ is an edge, then the diagram

$$\begin{array}{ccc}
T(w \times v) & \xrightarrow{T(\text{id} \times \gamma)} & T(w \times v') \\
\tau \downarrow & & \downarrow \tau \\
T(w) \otimes T(v) & \xrightarrow{\text{id} \otimes T(\gamma)} & T(w) \otimes T(v')
\end{array}$$

commutes.

4. The diagram

$$\begin{array}{ccc}
T(v \times (w \times u)) & \xrightarrow{T(\beta_{v,w,u})} & T((v \times w) \times u) \\
\downarrow & & \downarrow \\
T(v) \otimes T(w \times u) & & T(v \times w) \otimes T(u) \\
\downarrow & & \downarrow \\
T(v) \otimes (T(w) \otimes T(u)) & \longrightarrow & (T(v) \otimes T(w)) \otimes T(u)
\end{array}$$

commutes where the lower horizontal map is the standard isomorphism.

5. The maps $T(\beta_{v,w,u})$ and $T(\beta'_{v,w,u})$ are inverse to each other. In particular, the diagram for $T(\beta'_{v,w,u})$ commutes as well.

A *unit* for a graded diagram with commutative product structure D is a vertex $\mathbf{1}$ of degree 0 together with a choice of edges

$$u_v : v \rightarrow \mathbf{1} \times v$$

for all vertices of v . A graded multiplicative representation is *unital* if $T(\mathbf{1})$ is free of rank 1 and there is a choice of isomorphism $R \rightarrow T(\mathbf{1})$ such that for all v the map $T(u_v)$ is equal to the isomorphism

$$T(v) \xleftarrow{\cong} R \otimes_R T(v) \rightarrow T(\mathbf{1}) \otimes_R T(v) = T(\mathbf{1} \times v).$$

Remark 8.1.4. 1. In particular, $T(\alpha_{v,w})$ and $T(\beta_{v,w,u})$ are isomorphisms.

If $v = w$ then $T(\alpha_{v,v}) = (-1)^{|v|}$.

2. Note that the first and the second factor are *not* treated symmetrically. There is a choice of sign convention involved. The convention above is chosen to be consistent with that of Section 1.3. Eventually, we want to

view relative singular cohomology as graded multiplicative representation in the above sense.

3. For the purposes immediately at hand, the choice of $\beta'_{v,w,u}$ is not needed. However, it is needed later on in the definition of the product structure on the localised diagram, see Remark 8.2.2.

Let $T : D \rightarrow R\text{-Proj}$ be a representation of a diagram with identities. Recall that we defined its diagram category $\mathcal{C}(D, T)$, see Definition 7.1.10. If R is a field or a Dedekind domain, then $\mathcal{C}(D, T)$ can be described as the category of $A(D, T)$ -comodules of finite type over R for the coalgebra $A(D, T)$ defined in Theorem 7.1.12.

Proposition 8.1.5. *Let D be a graded diagram with commutative product structure with unit and T a unital graded multiplicative representation of D in $R\text{-Proj}$*

$$T : D \rightarrow R\text{-Proj}.$$

1. *Then $\mathcal{C}(D, T)$ carries the structure of a commutative and associative tensor category with unit and $T : \mathcal{C}(D, T) \rightarrow R\text{-Mod}$ is a tensor functor. On the generators $\tilde{T}(v)$ of $\mathcal{C}(D, T)$ the associativity constraint is induced by the edges $\beta_{v,w,u}$, the commutativity constraint is induced by the edges $\alpha_{v,w}$, the unit object is $\tilde{\mathbf{1}}$ with unital maps induced by the edges u_v .*
2. *If, in addition, R is a field or a Dedekind domain, the coalgebra $A(D, T)$ carries a natural structure of a commutative bialgebra (with unit and counit). The scheme $M = \text{Spec}(A(D, T))$ is a faithfully flat unital monoid scheme over $\text{Spec}(R)$.*

Proof. We consider finite diagrams F and F' such that

$$\{v \times w | v, w \in F\} \subset F'.$$

We are going to define natural maps

$$\mu_F^* : \text{End}(T|_{F'}) \rightarrow \text{End}(T|_F) \otimes \text{End}(T|_F).$$

Assume this for the moment. We are going to explain first how all assertions follow. Let $X, Y \in \mathcal{C}(D, T)$. We want to define $X \otimes Y$ in $\mathcal{C}(D, T) = 2\text{-colim}_F \mathcal{C}(F, T)$. Let F be such that $X, Y \in \mathcal{C}(F, T)$. This means that X and Y are finitely generated R -modules with an action of $\text{End}(T|_F)$. We equip the R -module $X \otimes Y$ with a structure of an $\text{End}(T|_{F'})$ -module. It is given by

$$\text{End}(T|_{F'}) \otimes X \otimes Y \rightarrow \text{End}(T|_F) \otimes \text{End}(T|_F) \otimes X \otimes Y \rightarrow X \otimes Y$$

where we have used the comultiplication map μ_F^* and the module structures of X and Y . This will be independent of the choice of F and F' . It is easy to check that the properties of \otimes on $\mathcal{C}(D, T)$ as in 1. follow from properties of μ_F^* . If R is a field or a Dedekind domain, let

$$\mu_F : A(F, T) \otimes A(F, T) \rightarrow A(F', T)$$

be dual to μ_F^* . Passing to the direct limit defines a multiplication μ on $A(D, T)$ as claimed in 2. The statement on $\text{Spec}(A(D, T))$ is then obvious.

We now turn to the construction of μ_F^* . Let $a \in \text{End}(T|_{F'})$, i.e., a compatible system of endomorphisms $a_v \in \text{End}(T(v))$ for $v \in F'$. We describe its image $\mu_F^*(a)$. Let $(v, w) \in F \times F$. The isomorphism

$$\tau : T(v \times w) \rightarrow T(v) \otimes_R T(w)$$

induces an isomorphism

$$\text{End}(T(v \times w)) \cong \text{End}(T(v)) \otimes_R \text{End}(T(w)).$$

We define the (v, w) -component of $\mu^*(a)$ to be the image of $a_{v \times w}$ under this isomorphism.

In order to show that this is a well-defined element of $\text{End}(T|_F) \otimes \text{End}(T|_F)$, we need to check that diagrams of the form

$$\begin{array}{ccc} T(v) \otimes T(w) & \xrightarrow{\mu^*(a)_{(v,w)}} & T(v) \otimes T(w) \\ T(\alpha) \otimes T(\beta) \downarrow & & \downarrow T(\alpha) \otimes T(\beta) \\ T(v') \otimes T(w') & \xrightarrow{\mu^*(a)_{(v',w')}} & T(v') \otimes T(w') \end{array}$$

commute for all edges $\alpha : v \rightarrow v'$, $\beta : w \rightarrow w'$ in F . We factor

$$T(\alpha) \otimes T(\beta) = (T(\text{id}) \otimes T(\beta)) \circ (T(\alpha) \circ T(\text{id}))$$

and check the factors separately.

Consider the diagram

$$\begin{array}{ccccc} T(v \times w) & \xrightarrow{a_{v \times w}} & T(v \times w) & & \\ \downarrow T(\alpha \times \text{id}) & \searrow \tau & & \swarrow \tau & \downarrow T(\alpha \times \text{id}) \\ & T(v) \otimes T(w) & \xrightarrow{\mu^*(a)_{(v,w)}} & T(v) \otimes T(w) & \\ & \downarrow T(\alpha) \otimes T(\text{id}) & & \downarrow T(\alpha) \otimes T(\text{id}) & \\ & T(v') \otimes T(w) & \xrightarrow{\mu^*(a)_{(v',w')}} & T(v') \otimes T(w) & \\ \downarrow T(\alpha \times \text{id}) & \swarrow \tau & & \swarrow \tau & \downarrow T(\alpha \times \text{id}) \\ T(v' \times w) & \xrightarrow{a_{v' \times w}} & T(v' \times w) & & \end{array}$$

The outer square commutes because a is a diagram endomorphism of F' . The top and bottom square commute by definition of $\mu^*(a)$. The left- and

right-hand square commute by property (3), up to the same sign $(-1)^{|w||\alpha|}$. Hence the middle square commutes without signs. The analogous diagram for $\text{id} \times \beta$ commutes on the nose. Hence $\mu^*(a)$ is well-defined.

We now want to compare the (v, w) -component to the (w, v) -component. Recall that there is a distinguished edge $\alpha_{v,w} : v \times w \rightarrow w \times v$. Consider the diagram

$$\begin{array}{ccccc}
 & & T(v) \otimes T(w) & \xrightarrow{\mu^*(a)_{(v,w)}} & T(v) \otimes T(w) \\
 & \nearrow \tau & \downarrow & & \downarrow & \nwarrow \tau \\
 T(v \times w) & \xrightarrow{\alpha_{v \times w}} & & & & \xrightarrow{\alpha_{v \times w}} & T(v \times w) \\
 \downarrow T(\alpha_{v,w}) & & & & & & \downarrow T(\alpha_{v,w}) \\
 T(w \times v) & \xrightarrow{\alpha_{w \times v}} & & & & \xrightarrow{\alpha_{w \times v}} & T(w \times v) \\
 & \nwarrow \tau & \downarrow & & \downarrow & \nearrow \tau & \\
 & & T(w) \otimes T(v) & \xrightarrow{\mu^*(a)_{(w,v)}} & T(w) \otimes T(v) & &
 \end{array}$$

By the construction of $\mu^*(a)_{(v,w)}$ (resp. $\mu^*(a)_{(w,v)}$), the upper (resp. lower) tilted square commutes. By naturality, the middle rectangle with $\alpha_{v,w}$ commutes. By property (1) of a representation of a graded diagram with commutative product, the left and right faces commute where the vertical maps are $(-1)^{|v||w|}$ times the natural commutativity of tensor products of T -modules. Hence the inner square also commutes without the sign factors. This is co-commutativity of μ^* .

The associativity assumption (4) for representations of diagrams with product structure implies the coassociativity of μ^* .

The compatibility of multiplication and comultiplication is built into the definition.

In order to define a unit object in $\mathcal{C}(D, T)$ it suffices to define a counit for $\text{End}(T|_F)$. Assume $\mathbf{1} \in F$. The counit

$$u^* : \text{End}(T|_F) \subset \prod_{v \in F} \text{End}(T(v)) \rightarrow \text{End}(T(\mathbf{1})) = R$$

is the natural projection. The assumption on unitality of T allows us to check that the required diagrams commute.

This finishes the argument for the tensor category and its properties. If R is a field or a Dedekind domain, we have shown that $A(D, T)$ has a multiplication and a comultiplication. The unit element $1 \in A(D, T)$ is induced from the canonical element $1 \in A(\{\mathbf{1}\}, T) = \text{End}_R(T(\mathbf{1}))^\vee = R$ (note that the last identification is indeed canonical, independent of the choice of basis vector in $T(\mathbf{1}) \cong R$.) It remains to show that $1 \neq 0$ in $A(D, T)$ or, equivalently, its

image is non-zero in all $A(F, T)$ with F a finite diagram containing $\mathbf{1}$. We can view $\mathbf{1}$ as a map

$$\text{End}(T|_F) \rightarrow R.$$

It is non-zero because it maps id to $\mathbf{1}$. \square

Remark 8.1.6. The proof of Proposition 8.1.5 works without any changes in the arguments when we weaken the assumptions as follows: in Definition 8.1.3 replace \times by a map of diagrams with identities

$$\times : D \times D \rightarrow \mathcal{P}(D)$$

where $\mathcal{P}(D)$ is the path category of D : objects are the vertices of D and morphisms the paths. We view $\mathcal{P}(D)$ as a diagram with identities by viewing the identity edges of D as a path of length one. (Sic, not via the more natural choice of the empty word.) It is graded by the grading on D .

A representation T of D extends canonically to a functor on $\mathcal{P}(D)$.

Example 8.1.7. Let $D = \mathbb{N}_0$. We are going to define the set of edges such that it allows for the definition of a commutative product structure which makes $n \mapsto V^{\otimes n}$ (for a fixed vector space V) a multiplicative representation. The only edges are self-edges. We denote them suggestively by

$$\text{id}_a \times \alpha_{v,w} \times \text{id}_b : a + v + w + b \rightarrow a + w + v + b$$

with $a, b, v, w \in \mathbb{N}_0$. We identify $\text{id}_a \times \alpha_{0,0} \times \text{id}_b = \text{id}_{a+b}$ and abbreviate $\text{id}_0 \times \alpha_{v,w} \times \text{id}_0 = \alpha_{v,w}$. We turn it into a graded diagram via the trivial grading $|n| = 0$ for all $n \in \mathbb{N}$.

The summation map

$$\mathbb{N}_0 \times \mathbb{N}_0 \rightarrow \mathbb{N}_0 \quad (n, m) \mapsto n + m$$

defines a commutative product structure on \mathbb{N}_0 in the sense of Definition 8.1.3. The definition on edges is the obvious one. All edges $\beta_{v,w,u}, \beta'_{v,w,u}$ are given by the identity. The edges $\alpha_{v,w}$ are the ones specified before. The unit $\mathbf{1}$ is given by the vertex 0 , the edges u_v are given by the identity.

Let V be a finite-dimensional k -vector space for some field k . We define a unital graded multiplicative representation

$$T = T_V : \mathbb{N}_0 \rightarrow k\text{-Mod} \quad n \mapsto V^{\otimes n}.$$

The morphisms

$$\tau_{(v,w)} : T(v \times w) = V^{\otimes(n+m)} \rightarrow T(v) \otimes T(w)$$

are the natural ones. All conditions are satisfied. We have in particular $T(0) = k$.

By Proposition 8.1.5, the coalgebra $A = A(\mathbb{N}_0, T)$ is a commutative bialgebra. Indeed, $\text{Spec}(A) = \text{End}(V)$ may be viewed as an algebraic monoid over k . In more detail: The commutative algebra A is generated freely by

$$A(\{1\}, T) = \text{End}_k(V)^\vee.$$

Let v_1, \dots, v_n be a basis of V . Then

$$A(\mathbb{N}_0, T) = k[X_{ij}]_{i,j=1}^n$$

with X_{ij} the element dual to $E_{ij} : V \rightarrow V$ with $E_{ij}(v_s) = \delta_{is}v_j$. The comultiplication Δ is determined by its value on the X_{ij} where it is induced by multiplication of the E_{ij} . Hence

$$\Delta(X_{ij}) = \sum_{s=1}^n X_{is}X_{sj}.$$

As a second, less trivial example we consider the case of an abelian tensor category with a faithful fibre functor.

Example 8.1.8. Let R be a commutative ring. Let \mathcal{C} be an R -linear associative and commutative abelian tensor category with unit object $\mathbf{1}$ and $T : \mathcal{C} \rightarrow R\text{-Mod}$ a faithful exact tensor functor. The tensor structure defines a commutative product structure on \mathcal{C} in the sense of Definition 8.1.3, where we use the trivial grading.

If R is a field, then T is a unital graded multiplicative representation of \mathcal{C} viewed as a diagram. All assumptions of Proposition 8.1.5 are satisfied. Hence $\mathcal{C} \cong \mathcal{C}(\mathcal{C}, T)$ (see Theorem 7.1.20) is the tensor category $A(\mathcal{C}, T)\text{-Comod}$ for the bialgebra $A(\mathcal{C}, T)$ or, equivalently, the category of algebraic representations of the monoid scheme $\text{Spec}(A(\mathcal{C}, T))$ on finite-dimensional R -vector spaces.

We also want to establish the version where R is a Dedekind ring.

Definition 8.1.9. Let R be a Dedekind ring and \mathcal{C} and T be as in Example 8.1.8. We say that an object $X \in \mathcal{C}$ is T -projective, if $T(X)$ is projective. Let $\mathcal{C}^{\text{Proj}}$ be the full subcategory of T -projective objects of \mathcal{C} . Let $S \subset \mathcal{C}^{\text{Proj}}$ be a set of objects and

$$\langle S \rangle^{\otimes, \text{psab}} := \langle V^{\otimes n} \mid n \in \mathbb{N}_0, V \in S \rangle^{\text{psab}}$$

be the full pseudo-abelian tensor subcategory of \mathcal{C} generated by S . We say that S generates \mathcal{C} (as abelian tensor category) relative to T if the natural inclusion

$$\mathcal{C}(\langle S \rangle^{\otimes, \text{psab}}, T) \rightarrow \mathcal{C}$$

is an equivalence.

Note that if \mathcal{C} is generated by S relative to T , then it is also generated by $\mathcal{C}^{\text{Proj}} = \langle \mathcal{C}^{\text{Proj}} \rangle^{\otimes, \text{psab}}$ and

$$A(\langle S \rangle^{\otimes, \text{psab}}, T) = A(\mathcal{C}^{\text{Proj}}, T).$$

Example 8.1.10. Let $R = \mathbb{Z}$ and $\tilde{\mathcal{C}}$ be the abelian category of finitely generated abelian groups equipped with an endomorphism. Let T be the functor forgetting the endomorphisms. Let \mathcal{C} be the full subcategory of those objects (X, f) where $f \otimes_{\mathbb{Z}} \mathbb{Q} = \text{id}$. This is a unital abelian tensor category and the forgetful functor is a unital tensor functor. An object (X, f) is T -projective if X is free. In this case f is the identity. Hence the subcategory $\mathcal{C}(\mathcal{C}^{\text{Proj}}, T) \subset \mathcal{C}$ contains only objects (Y, g) with $g = \text{id}$. On the other hand, an object (Y, g) with Y torsion and g arbitrary is in \mathcal{C} . Hence, \mathcal{C} is not generated by $\mathcal{C}^{\text{Proj}}$ relative to T . It does not even agree with $\langle \mathcal{C}^{\text{Proj}} \rangle$.

Lemma 8.1.11. *Let D be a graded diagram with a commutative product structure. Let $T : D \rightarrow R\text{-Proj}$ be a graded multiplicative representation. Let*

$$D \xrightarrow{\tilde{T}} \mathcal{C}(D, T)$$

be the canonical functor to the diagram category. Then $\mathcal{C}(D, T)$ is generated by $\{\tilde{T}v | v \in V(D)\}$ as an abelian tensor category in the sense of Definition 8.1.9.

Proof. By construction of the tensor product on $\mathcal{C}(D, T)$, the set $\{\tilde{T}v | v \in V(D)\}$ contains $\mathbf{1}$ and is closed under tensor products. Hence we have to show that $\mathcal{C}(\langle \tilde{T}v | v \in V(D) \rangle^{\text{psab}}, T)$ is equivalent to $\mathcal{C}(D, T)$. We consider the maps of diagrams

$$D \rightarrow \langle \tilde{T}v | v \in V(D) \rangle^{\text{psab}} \rightarrow \mathcal{C}(D, T)$$

with their compatible representations in $R\text{-Mod}$ and pass to the diagram categories. This is functorial by Lemma 7.2, hence

$$\mathcal{C}(D, T) \rightarrow \mathcal{C}(\langle \tilde{T}v | v \in V(D) \rangle^{\text{psab}}, T) \rightarrow \mathcal{C}(\mathcal{C}(D, T), f_T) \cong \mathcal{C}(D, T).$$

The composition is equivalent to the identity. Hence the second functor is full and essentially surjective. It is faithful because all involved categories have faithful exact functors to $R\text{-Mod}$. \square

Corollary 8.1.12. *Let R be a Dedekind ring and \mathcal{C} a non-zero abelian tensor category. Let $T : \mathcal{C} \rightarrow R\text{-Mod}$ be a faithful exact unital tensor functor. Let $S \subset \mathcal{C}^{\text{Proj}}$ be a set of T -projective objects that generate \mathcal{C} relative to T in the sense of Definition 8.1.9.*

1. *For every $V \in \mathcal{C}^{\text{Proj}}$, the bialgebra $A(\langle V \rangle^{\otimes, \text{psab}}, T)$ is finitely generated as a commutative R -algebra by a quotient of $\text{End}_R(TV)^\vee$.*
2. *We have*

$$A(\langle S \rangle^{\otimes, \text{psab}}, T) = \varinjlim_{V \in \langle S \rangle^{\otimes, \text{psab}}} A(\langle V \rangle^{\otimes, \text{psab}}, T).$$

Proof. The direct limit description is obvious from the constructions.

We now fix V and put $A := A(\langle V \rangle^{\otimes, \text{psab}}, T)$. The tensor structure on \mathcal{A} restricts to $\langle V \rangle^{\otimes, \text{psab}}$, turning A into a bialgebra. We have

$$A = \varinjlim A_n$$

with

$$A_n = A(\langle \mathbf{1}, V, V^{\otimes 2}, \dots, V^{\otimes n} \rangle^{\text{psab}}, T).$$

By Lemma 7.3.14 1, we have an injective map

$$A_n^\vee \rightarrow \bigoplus_{i=0}^n \text{End}_R(T(V)^{\otimes i})$$

where A_n^\vee consists of those endomorphisms compatible with all morphisms in the subcategory. Hence, there is a surjective map

$$\bigoplus_{i=0}^n \text{End}_R(T(V)^{\otimes i})^\vee \rightarrow A_n.$$

In the limit, this gives a surjection of bialgebras

$$\bigoplus_{i=0}^{\infty} \text{End}_R((T(V)^{\otimes i})^\vee) \rightarrow A$$

and the kernel is generated by the relation defined by compatibility with morphisms in \mathcal{C} . One such relation is the commutativity constraint, hence the map factors via the symmetric algebra

$$\text{Sym}^*(\text{End}(T(V)^\vee)) \rightarrow A.$$

The algebra on the left is finitely generated by an R -basis of $\text{End}_R(TV)^\vee$. \square

Note that $\text{Sym}^*(\text{End}(T(V)^\vee))$ is canonically the ring of regular functions on the algebraic monoid $\text{End}(T(V))$.

It is also possible to translate the result to the language of representations of the associated monoid scheme. Note that this is not a completely obvious notion. We follow Milne, see [Mil12, Chapter VIII, Section 2].

Definition 8.1.13. Let R be a field or a Dedekind domain. Let M be a flat affine unital monoid scheme over R . Let V be an R -module. A *linear algebraic representation* of M on V is defined as a transformation of functors on R -algebras

$$M(S) \times V \otimes_R S \rightarrow V \otimes_R S,$$

such that for every R -algebra S the map is an S -linear operation of the monoid $M(S)$.

Remark 8.1.14. If V is finitely generated projective, e.g., if R is a field, then the functor $S \mapsto V \otimes_R S$ is represented by $\text{Spec}(\text{Sym}^* V^\vee)$. We call this scheme V again. A linear algebraic representation is then given by

$$M \times V \rightarrow V.$$

It induces a morphism of monoid schemes

$$M \rightarrow \text{End}_R(V).$$

Such a translation is not possible if V is not projective.

Proposition 8.1.15. *Let R be a field or a Dedekind domain. Let M be a flat affine unital monoid scheme over R . Let $A = \mathcal{O}(M)$ be the associated bialgebra.*

Then the category $A\text{-Comod}$ is equivalent to the category of linear representations of M on finitely generated R -modules.

Proof. The case of fields can be found in [Wat79, Section 3.2] in which the case of group schemes is treated. Only the monoid part is used here. The same argument also applies to the case where R is a Dedekind domain. Full details can be found in [Mil12, Proposition 6.1]. \square

Remark 8.1.16. Let V be projective. By the proposition, we have a right comodule structure

$$V \rightarrow V \otimes_R A.$$

On the other hand, taking global sections of $M \times V \rightarrow V$, we also get a left comodule

$$\text{Sym}^* V^\vee \rightarrow A \otimes_R \text{Sym}^* V^\vee.$$

It is in addition a morphism of algebras. It is induced by the right comodule by passing to the contragredient left comodule

$$V^\vee \rightarrow A \otimes_R V^\vee$$

and extending to the universal algebra homomorphism on $\text{Sym}^* V^\vee$.

Corollary 8.1.17. *Let R be a Dedekind ring and \mathcal{C} a non-zero abelian tensor category. Let $T : \mathcal{C} \rightarrow R\text{-Mod}$ be a faithful exact unital tensor functor. Let $S \subset \mathcal{C}^{\text{Proj}}$ be a set of T -projective objects that generate \mathcal{C} relative to T in the sense of Definition 8.1.9. Then the category \mathcal{C} is equivalent to the category of representations of the monoid $\text{Spec}(A(\langle S \rangle^{\otimes, \text{psab}}, T))$.*

Proof. By Definition, the category \mathcal{C} is equivalent to $A(\langle S \rangle^{\otimes, \text{psab}}, T)\text{-Comod}$. The claim follows by Proposition 8.1.15. \square

8.2 Localisation

The purpose of this section is to give a diagram version of the localisation of a tensor category with respect to one object, i.e., a distinguished object X becomes invertible with respect to the tensor product. This is the standard construction used to pass, for example, from effective motives to all motives.

We restrict to the case when R is a field or a Dedekind domain and all representations of diagrams take values in $R\text{-Proj}$.

Definition 8.2.1 (Localisation of diagrams). Let D^{eff} be a graded diagram with a commutative product structure with unit $\mathbf{1}$. Let $v_0 \in D^{\text{eff}}$ be a vertex. The *localised diagram* D has vertices and edges as follows:

1. for every vertex v of D^{eff} and $n \in \mathbb{Z}$ a vertex denoted $v(n)$;
2. for every edge $\alpha : v \rightarrow w$ in D^{eff} and every $n \in \mathbb{Z}$, an edge denoted $\alpha(n) : v(n) \rightarrow w(n)$ in D ;
3. for every vertex v in D^{eff} and every $n \in \mathbb{Z}$ an edge denoted $(v \times v_0)(n) \rightarrow v(n+1)$.

Put $|v(n)| = |v|$.

We equip D with a weak commutative product structure in the sense of Remark 8.1.6

$$\times : D \times D \rightarrow \mathcal{P}(D) \quad v(n) \times w(m) \mapsto (v \times w)(n+m)$$

together with

$$\begin{aligned} \alpha_{v(n),w(m)} &= \alpha_{v,w}(n+m), \\ \beta_{v(n),w(m),u(r)} &= \beta_{v,w,u}(n+m+r), \\ \beta'_{v(n),w(m),u(r)} &= \beta'_{v,w,u}(n+m+r). \end{aligned}$$

Let $\mathbf{1}(0)$ together with

$$u_{v(n)} = u_v(n)$$

be the unit.

Note that there is a natural inclusion of diagrams with commutative product structure $D^{\text{eff}} \rightarrow D$ which maps a vertex v to $v(0)$.

Remark 8.2.2. The above definition does not spell out \times on edges. It is induced from the product structure on D^{eff} for edges of type (2). For edges of type (3) there is an obvious sequence of edges. We take their composition in $\mathcal{P}(D)$. For example, for $\gamma_{v,n} : (v \times v_0)(n) \rightarrow v(n+1)$ and $\text{id}_{w(m)} = \text{id}_w(m) : w(m) \rightarrow w(m)$ we have

$$\gamma_{v,n} \times \text{id}(m) : (v \times v_0)(n) \times w(m) \rightarrow v(n+1) \times w(m)$$

via

$$\begin{aligned}
(v \times v_0)(n) \times w(m) &= ((v \times v_0) \times w)(n+m) \\
&\xrightarrow{\beta'_{v,v_0,w}(n+m)} (v \times (v_0 \times w))(n+m) \\
&\xrightarrow{\text{id} \times \alpha_{v_0,w}(n+m)} (v \times (w \times v_0))(n+m) \\
&\xrightarrow{\beta_{v,w,v_0}(n+m)} ((v \times w) \times v_0)(n+m) \\
&\xrightarrow{\gamma_{v \times w, n+m}} (v \times w)(n+m+1) = v(n+1) \times w(m).
\end{aligned}$$

Assumption 8.2.3. Let R be a field or a Dedekind domain. Let T be a multiplicative unital representation of D^{eff} with values in $R\text{-Proj}$ such that $T(v_0)$ is locally free of rank 1 as an R -module.

Lemma 8.2.4. *Under Assumption 8.2.3, the representation T extends uniquely to a graded multiplicative representation of D such that $T(v(n)) = T(v) \otimes T(v_0)^{\otimes n}$ for all vertices and $T(\alpha(n)) = T(\alpha) \otimes T(\text{id})^{\otimes n}$ for all edges. It is multiplicative and unital with the choice*

$$\begin{array}{ccc}
T(v(n) \times w(m)) & \xrightarrow{\tau_{v(n),w(m)}} & T(v(n)) \otimes T(w(m)) \\
\tau_{v,w} \otimes \text{id} \downarrow & & \downarrow = \\
T(v) \otimes T(w) \otimes T(v_0)^{\otimes(n+m)} & \xrightarrow{\cong} & T(v) \otimes T(v_0)^{\otimes n} \otimes T(w) \otimes T(v_0)^{\otimes m}
\end{array}$$

where the last line is the natural isomorphism.

Proof. Define T on the vertices and edges of D via the formula. It is tedious but straightforward to check the conditions. \square

Proposition 8.2.5. *Let D^{eff} , D and T be as above. Assume Assumption 8.2.3. Let $A(D, T)$ and $A(D^{\text{eff}}, T)$ be the corresponding bialgebras. Then:*

1. $\mathcal{C}(D, T)$ is the localisation of the category $\mathcal{C}(D^{\text{eff}}, T)$ with respect to the object $\tilde{T}(v_0)$.
2. Let $\chi \in \text{End}(T(v_0))^\vee = A(\{v_0\}, T)$ be the dual of $\text{id} \in \text{End}(T(v_0))$. We view it in $A(D^{\text{eff}}, T)$. Then $A(D, T) = A(D^{\text{eff}}, T)_\chi$, the localisation of algebras.

Proof. Let $D^{\geq n} \subset D$ be the subdiagram with vertices of the form $v(n')$ with $n' \geq n$. Clearly, $D = \text{colim}_n D^{\geq n}$, and hence

$$\mathcal{C}(D, T) \cong 2\text{-colim}_n \mathcal{C}(D^{\geq n}, T).$$

Consider the morphism of diagrams

$$D^{\geq n} \rightarrow D^{\geq n+1}; \quad v(m) \mapsto v(m+1).$$

It is clearly an isomorphism. We equip $\mathcal{C}(D^{\geq n+1}, T)$ with a new fibre functor $f_T \otimes T(v_0)^\vee$. It is faithful exact. The map $v(m) \mapsto \tilde{T}(v(m+1))$ is a rep-

resentation of $D^{\geq n}$ in the abelian category $\mathcal{C}(D^{\geq n+1}, T)$ with fibre functor $f_T \otimes T(v_0)^\vee$. By the universal property, this induces a functor

$$\mathcal{C}(D^{\geq n}, T) \rightarrow \mathcal{C}(D^{\geq n+1}, T).$$

The converse functor is constructed in the same way. Hence

$$\mathcal{C}(D^{\geq n}, T) \cong \mathcal{C}(D^{\geq n+1}, T), \quad A(D^{\geq n}, T) \cong A(D^{\geq n+1}, T).$$

The map of graded diagrams with commutative product and unit

$$D^{\text{eff}} \rightarrow D^{\geq 0}$$

induces an equivalence on tensor categories. Indeed, we represent $D^{\geq 0}$ in $\mathcal{C}(D^{\text{eff}}, T)$ by mapping $v(m)$ to $\tilde{T}(v) \otimes \tilde{T}(v_0)^m$. By the universal property (see Corollary 7.1.19), this implies that there is a faithful exact functor

$$\mathcal{C}(D^{\geq 0}, T) \rightarrow \mathcal{C}(D^{\text{eff}}, T)$$

inverse to the obvious inclusion. Hence we also have $A(D^{\text{eff}}, T) \cong A(D^{\geq 0}, T)$ as unital bialgebras.

On the level of coalgebras, this implies

$$A(D, T) = \text{colim}_n A(D^{\geq n}, T) = \text{colim}_n A(D^{\text{eff}}, T)$$

because $A(D^{\geq n}, T)$ is isomorphic to $A(D^{\text{eff}}, T)$ as coalgebras. The coalgebra $A(D^{\text{eff}}, T)$ also has a multiplication, but the $A(D^{\geq n}, T)$ for general $n \in \mathbb{Z}$ do not. However, they carry a weak $A(D^{\text{eff}}, T)$ -module structure analogous to Remark 8.1.6 corresponding to the map of graded diagrams

$$D^{\text{eff}} \times D^{\geq n} \rightarrow \mathcal{P}(D^{\geq n}).$$

We want to describe the transition maps of the direct limit. From the point of view of $D^{\text{eff}} \rightarrow D^{\text{eff}}$, it is given by $v \mapsto v \times v_0$.

In order to describe the transition maps $A(D^{\text{eff}}, T) \rightarrow A(D^{\text{eff}}, T)$, it suffices to describe $\text{End}(T|_F) \rightarrow \text{End}(T|_{F'})$ where F, F' are finite subdiagrams of D^{eff} such that $v \times v_0 \in V(F')$ for all vertices $v \in V(F)$. It is induced by

$$\text{End}(T(v)) \rightarrow \text{End}(T(v \times v_0)) \xrightarrow{\tau} \text{End}(T(v)) \otimes \text{End}(T(v_0)) : a \mapsto a \otimes \text{id}.$$

On the level of coalgebras, this corresponds to the map

$$A(D^{\text{eff}}, T) \rightarrow A(D^{\text{eff}}, T) : x \mapsto x\chi.$$

Note finally, that the direct limit $\text{colim} A(D^{\text{eff}}, T)$ with transition maps given by multiplication by χ agrees with the localisation $A(D^{\text{eff}}, T)_\chi$. \square

Remark 8.2.6. In order to show that the localisation of a tensor category with respect to some object L is again a tensor category, there is a condition to check: permutation has to act trivially on $L \otimes L$. This is a non-issue in the case of $\mathcal{C}(D, T)$ and $L = \tilde{T}(v_0)$ because $\mathcal{C}(D, T) \rightarrow R\text{-Mod}$ is a tensor functor and the condition is satisfied in $R\text{-Mod}$.

8.3 Nori's rigidity criterion

Implicit in Nori's construction of motives is a rigidity criterion, which we are now going to formulate and prove explicitly.

Let R be a Dedekind domain or a field and \mathcal{C} an R -linear tensor category. Recall that $R\text{-Mod}$ is the category of finitely generated R -modules and $R\text{-Proj}$ the category of finitely generated projective R -modules.

We assume that the tensor product on \mathcal{C} is associative, commutative and unital. Let $\mathbf{1}$ be the unit object. Let $T : \mathcal{C} \rightarrow R\text{-Mod}$ be a faithful exact unital tensor functor with values in $R\text{-Mod}$. By definition this means $T(\mathbf{1}) = R$.

Recall from Definition 8.1.9 that an object X is called T -projective if $T(X)$ is projective. We say that \mathcal{C} is generated by a class S of T -projective objects relative to T if

$$\mathcal{C}(\langle S \rangle^{\otimes, \text{psab}}, T) \rightarrow \mathcal{C}$$

is an equivalence of categories. By Proposition 8.1.15 the condition implies that \mathcal{C} is equivalent to the category of representations of the monoid scheme $M = \text{Spec}(A(\langle S \rangle^{\otimes, \text{psab}}, T))$ in finitely generated R -modules. The aim of this section is to find a criterion for this monoid to be a group scheme over our base ring R .

Definition 8.3.1. 1. Let \mathcal{C} be as above with R a field. We say that \mathcal{C} is *rigid* if every object $V \in \mathcal{C}$ has a strong dual V^\vee , i.e., for all $X, Y \in \mathcal{C}$ there are natural isomorphisms

$$\begin{aligned} \text{Hom}(X \otimes V, Y) &\cong \text{Hom}(X, V^\vee \otimes Y), \\ \text{Hom}(X, V \otimes Y) &\cong \text{Hom}(X \otimes V^\vee, Y). \end{aligned}$$

2. Let \mathcal{C} and T be as above with R a Dedekind ring. Assume in addition that \mathcal{C} is generated by $\mathcal{C}^{\text{Proj}}$ (as an abelian tensor category) relative to T . We say that \mathcal{C} is *rigid* if every T -projective object V of \mathcal{C} has a strong dual.

Note that this is in conflict with standard terminology in the second case. In the field case, standard Tannaka duality implies that the Tannaka dual of \mathcal{C} is a group scheme over R . We are going to establish the same in the second case. Actually, we are going to show below that a weaker assumption suffices. For this, we introduce an ad-hoc notion.

Definition 8.3.2. Let V be an object of \mathcal{C} . We say that V *admits a perfect duality* if either there is a morphism

$$q : V \otimes V \rightarrow \mathbf{1},$$

such that $T(V)$ is projective and $T(q)$ is a non-degenerate bilinear form, or if there is a morphism

$$\mathbf{1} \rightarrow V \otimes V$$

such that $T(V)$ is projective and the dual of $T(q)$ is a non-degenerate bilinear form.

Recall from Definition 8.1.9 that by $\langle V \rangle^{\otimes, \text{psab}}$ we denote the full pseudo-abelian unital tensor subcategory of \mathcal{C} containing V , i.e.,

$$\langle V \rangle^{\otimes, \text{psab}} = \langle V^{\otimes n} \mid n \in \mathbb{N}_0 \rangle^{\text{psab}}.$$

We start with the simplest case of the criterion.

Lemma 8.3.3. *Let V be an object that admits a perfect duality in the sense of Definition 8.3.2. Then $M := \text{Spec}(A(\langle V \rangle^{\otimes, \text{psab}}, T))$ is an algebraic group scheme of finite type over $\text{Spec}(R)$.*

Proof. By Lemma 8.3.6, it suffices to show that there is a closed immersion $M \rightarrow G$ of monoids into an algebraic group G . By Corollary 8.1.12 1., we have a surjection

$$\text{Sym}^*(\text{End}(T(V)^\vee) \rightarrow A.$$

The kernel is generated by relations defined by compatibility with morphisms in the subcategory. One such is the pairing $q : V \otimes V \rightarrow \mathbf{1}$. We want to work out the explicit equation induced by q .

We choose a basis e_1, \dots, e_r of $T(V)$. Let

$$a_{i,j} = T(q)(e_i, e_j) \in R.$$

By assumption, the matrix $(a_{ij})_{ij}$ is invertible. Let X_{st} be the matrix coefficients on $\text{End}(T(V))$ corresponding to the basis e_i . Compatibility with q gives for every pair (i, j) the equation

$$\begin{aligned} a_{ij} &= q(e_i, e_j) \\ &= q((X_{rs}e_i, (X_{r's'}e_j)) \\ &= q\left(\sum_r X_{ri}e_r, \sum_{r'} X_{r'j}e_{r'}\right) \\ &= \sum_{r,r'} X_{ri}X_{r'j}q(e_r, e_{r'}) \\ &= \sum_{r,r'} X_{ri}X_{r'j}a_{rr'}. \end{aligned}$$

Note that the latter is the (i, j) -term in the product of matrices

$$X^t AX,$$

where we abbreviate $X = (X_{st})_{s,t}$, $A = (a_{rr'})_{r,r'}$. Let $B = A^{-1}$ be the inverse matrix. We define $Y = (Y_{st})_{st}$ as

$$Y = BX^t A.$$

Then

$$YX = BX^t AX = BA = E_r$$

is the unit matrix. In other words, our set of equations defines the isometry group $G(q) \subset \text{End}(T(V))$. We now have expressed A as a quotient of the ring of regular functions of $G(q)$.

The argument works in the same way if we are given

$$q : \mathbf{1} \rightarrow V \otimes V$$

instead. □

Proposition 8.3.4 (Nori). *Let \mathcal{C} and $T : \mathcal{C} \rightarrow R\text{-Mod}$ be as defined at the beginning of the section. Let $S = \{V_i | i \in I\}$ be a class of objects of $\mathcal{C}^{\text{Proj}}$ with the following properties:*

1. *It generates \mathcal{C} as an abelian tensor category relative to T in the sense of Definition 8.1.9, i.e., its diagram category is all of \mathcal{C} .*
2. *For every V_i there is an object W_i and a morphism*

$$q_i : V_i \otimes W_i \rightarrow \mathbf{1},$$

such that $T(q_i) : T(V_i) \otimes T(W_i) \rightarrow T(\mathbf{1}) = R$ is a perfect pairing of projective R -modules.

Then $\text{Spec}(A(\mathcal{C}^{\text{Proj}}, T))$ is a pro-algebraic group, and \mathcal{C} is rigid, see Definition 8.3.1.

Note that the assumptions include the condition that \mathcal{C} is generated by T -projectives relative to T , see the discussion at the beginning of the section.

Remark 8.3.5. 1. The proposition also holds with the dual assumption, i.e., existence of morphisms

$$q_i : \mathbf{1} \rightarrow V_i \otimes W_i$$

such that $T(q_i)^\vee : T(V_i)^\vee \otimes T(W_i)^\vee \rightarrow R$ is a perfect pairing.

2. If $R = k$ is a field, \mathcal{C} a rigid tensor category and $T : \mathcal{C} \rightarrow k\text{-Mod}$ a fibre functor, i.e., a faithful and exact tensor functor, then this completes the proof of Tannaka duality, i.e., \mathcal{C} is equivalent to the category of representations of the pro-algebraic group $\text{Spec}(A(\mathcal{C}, T))$.

Proof of Proposition 8.3.4.. Consider $V'_i = V_i \oplus W_i$. The pairing q_i extends to a symmetric map q'_i on $V'_i \otimes V'_i$ such that $T(q'_i)$ is non-degenerate. We

now replace V_i by V'_i . Without loss of generality, we can assume $V_i = W_i$. It admits a perfect duality in the sense of Definition 8.3.2.

For any finite subset $J \subset I$, let $V_J = \bigoplus_{j \in J} V_j$. Let q_J be the orthogonal sum of the q_j for $j \in J$. It is again a symmetric perfect pairing.

It suffices to show that A_J is a Hopf algebra. This is the case by Lemma 8.3.3. Note that the anti-podal map is uniquely determined by the bialgebra, or equivalently, the inversion map on an algebraic monoid is uniquely determined by the multiplication. Being a Hopf algebra is a property, not a choice. \square

Finally, the missing lemma on monoids.

Lemma 8.3.6. *Let R be a noetherian ring, G be an algebraic group scheme of finite type over R and $M \subset G$ a closed immersion of a submonoid with $1 \in M(R)$. Then M is an algebraic group scheme over R .*

Proof. This seems to be well-known. It appears as an exercise in [Ren05, Chapter 3]. We give the argument:

Let S be any finitely generated R -algebra. We have to show that the functor $S \mapsto M(S)$ takes values in the category of groups. It is a unital monoid by assumption. We take the base change of the situation to S . Hence, without loss of generality, it suffices to consider $R = S$. If $g \in G(R)$, we denote the isomorphism $G \rightarrow G$ induced by left multiplication with g also by $g : G \rightarrow G$. Take any $g \in G(R)$ such that $gM \subset M$ (for example $g \in M(R)$). Then one has

$$M \supseteq gM \supseteq g^2M \supseteq \dots$$

As G is noetherian, this sequence stabilises, say at $s \in \mathbb{N}$:

$$g^s M = g^{s+1} M$$

as closed subschemes of G . Since every g^s is an isomorphism, we obtain that

$$M = g^{-s} g^s M = g^{-s} g^{s+1} M = gM$$

as closed subschemes of G . So for every $g \in M(R)$ we showed that $gM = M$. Since $1 \in M(R)$, this implies that $M(R)$ is a subgroup. \square

Example 8.3.7. We explain the simplest example. It is a dressed-up version of Example 8.1.7 where we obtained an algebraic monoid. Let $D = \mathbb{N}_0$. We have the same self-edges $\text{id}_a \times \alpha_{v,w} \times \text{id}_b$ as previously and in addition edges $n+2 \rightarrow n$ denoted suggestively by $\text{id}_a \times b \times \text{id}_b : a+2+b \rightarrow a+b$.

We equip it with the trivial grading and the commutative product structure obtained by componentwise addition. The unit is given by 0 with $u_v = \text{id}$.

Let k be a field and (V, b) a finite-dimensional k -vector space with a non-degenerate bilinear form $b : V \times V \rightarrow k$. We define a graded multiplicative representation

$$T_{V,b} : \mathbb{N}_0 \rightarrow k\text{-Mod} : \quad v \mapsto V^{\otimes v}.$$

The edge b is mapped to the linear map $\tilde{b} : V^{\otimes 2} \rightarrow k$ induced by the bilinear map b . The assumptions of the rigidity criterion in Proposition 8.3.4 are satisfied for $\mathcal{C} = \mathcal{C}(D, T)$. Indeed, it is generated by the object $T(1) = V$ as an abelian tensor category. It is self-dual in the sense of the criterion in \mathcal{C} .

Let v_1, \dots, v_n be a basis of V and B the matrix of b . The bialgebra $A = A(\mathbb{N}_0, T_{V,b})$ is generated by symbols X_{ij} as in Example 8.1.7. We abbreviate $X = (X_{ij})_{ij}$. There is a relation coming from the edge b . It was computed in the proof of Lemma 8.3.3 as the matrix product

$$X^t B X = B.$$

Hence

$$X = \text{Spec}(A) = G(b)$$

is the isometry group of b as an algebraic group scheme. If, in addition, the bilinear form b is symmetric, it is the orthogonal group $O(b)$.

8.4 Comparing fibre functors

We pick up the story but with two representations instead of one. This will be central to our results on the structure of the formal period algebra in Chapter 13.

8.4.1 The space of comparison maps

Let R be a Dedekind domain or a field. Let $R\text{-Mod}$ be the category of finitely generated R -modules and $R\text{-Proj}$ the category of finitely generated projective modules. Let D be a graded diagram with a unital commutative product structure (see Definition 8.1.3) and $T_1, T_2 : D \rightarrow R\text{-Proj}$ two unital graded multiplicative representations. Recall that we have attached coalgebras $A_1 := A(D, T_1)$ and $A_2 := A(D, T_2)$ to these representations (see Theorem 7.1.12). They are even bialgebras by Proposition 8.1.5. The diagram categories $\mathcal{C}(D, T_1)$ and $\mathcal{C}(D, T_2)$ are defined as the categories of comodules for these coalgebras. They carry a structure of unital commutative tensor category.

Remark 8.4.1. In the case that D is the diagram defined by a rigid tensor category \mathcal{C} and T_1, T_2 are faithful tensor functors, it is a classical result of Tannaka theory that not only are $G_1 = \text{Spec}(A_1)$ and $G_2 = \text{Spec}(A_2)$ both groups, but they are forms of each other. Then all morphisms of tensor functors are isomorphisms and the space of all fibre functors is a torsor under G_1

and G_2 . Our aim is to imitate this as much as possible for a general diagram D . As we will see, the results will be weaker.

Definition 8.4.2. Let D be a diagram, R a Dedekind domain or a field. Let T_1 and T_2 be representations of D in $R\text{-Proj}$. Let $F \subset D$ be a finite subdiagram. We define

$$\text{Hom}(T_1|_F, T_2|_F) = \left\{ (f_p)_{p \in F} \in \prod_{p \in D} \text{Hom}_R(T_1 p, T_2 p) \mid f_q \circ T_1 m = T_2 m \circ f_p \ \forall p, q \in F \ \forall m \in D(p, q) \right\}.$$

Put

$$A_{1,2} := \varinjlim_F \text{Hom}(T_1|_F, T_2|_F)^\vee,$$

where $^\vee$ denotes the R -dual and F runs through all finite subdiagrams of D .

Note that our assumptions guarantee that $\text{Hom}(T_1|_F, T_2|_F)$ is a projective R -module and hence has a well-behaved R -dual.

Proposition 8.4.3. 1. *The operation*

$$\text{End}(T_1|_F) \times \text{Hom}(T_1|_F, T_2|_F) \rightarrow \text{Hom}(T_1|_F, T_2|_F)$$

induces a compatible comultiplication

$$A_1 \otimes_R A_{1,2} \leftarrow A_{1,2}.$$

The operation

$$\text{Hom}(T_1|_F, T_2|_F) \times \text{End}(T_2|_F) \rightarrow \text{Hom}(T_1|_F, T_2|_F)$$

induces a compatible comultiplication

$$A_{1,2} \otimes_R A_2 \leftarrow A_{1,2}.$$

The composition of homomorphisms

$$\text{Hom}(T_1|_F, T_2|_F) \times \text{Hom}(T_2|_F, T_1|_F) \times \text{Hom}(T_1|_F, T_2|_F) \rightarrow \text{Hom}(T_1|_F, T_2|_F)$$

induces a natural map

$$A_{1,2} \otimes A_{2,1} \otimes A_{1,2} \leftarrow A_{1,2}.$$

2. *Assume that D carries a unital commutative product structure and that T_1, T_2 are unital multiplicative representations. Then $A_{1,2}$ is a faithfully flat commutative unital R -algebra with multiplication induced by the tensor structure of the diagram category (unless $A_{1,2} = 0$) and the above maps are algebra homomorphisms.*

Proof. The statement on comultiplication follows in the same way as the comultiplication on A_1 and A_2 themselves, see Theorem 7.1.12. The module $A_{1,2}$ is faithfully flat over R because it is the direct limit of locally free R -modules.

The hard part is the existence of the multiplication. This follows by going through the proof of Proposition 8.1.5, and replacing $\text{End}(T|_F)$ by $\text{Hom}(T_1|_F, T_2|_F)$ in the appropriate places.

As T_1, T_2 are unital, there are distinguished isomorphisms $R \rightarrow T_i(\mathbf{1})$. This defines the distinguished isomorphisms

$$\text{Hom}_R(T_1(\mathbf{1}), T_2(\mathbf{1})) \cong \text{Hom}_R(R, R) \rightarrow R,$$

and

$$R \rightarrow \text{Hom}_R(T_1(\mathbf{1}), T_2(\mathbf{1})).$$

The element $1 \in A_{1,2}$ is the image of 1 under this map. \square

Note that the proof constructs an element $1 \in A_{1,2}$, but does not show that $1 \neq 0$.

Remark 8.4.4. As in Remark 8.1.6, a weak product structure on D suffices.

Lemma 8.4.5. *Let R be a Dedekind domain or a field. Let D be a diagram (with a unital commutative product structure). Let T_1 and T_2 be representations of D in $R\text{-Proj}$. Let S be a faithfully flat ring extension of R . Then the following data are equivalent:*

1. an R -linear map $\phi^\vee : A_{1,2} \rightarrow S$;
2. a morphism of representations $\Phi : T_1 \otimes S \rightarrow T_2 \otimes S$.

Moreover, every functor $\Phi : \mathcal{C}(D, T_1) \rightarrow \mathcal{C}(D, T_2)$ gives rise to a morphism of representations.

If, in addition, D carries a unital commutative product structure and T_1, T_2 are unital multiplicative representations of D in $R\text{-Proj}$, then the following data are equivalent:

1. a homomorphism of R -algebras $\phi^\vee : A_{1,2} \rightarrow S$;
2. a morphism of unital multiplicative representations $\Phi : T_1 \otimes_R S \rightarrow T_2 \otimes_R S$.

A tensor functor $\Phi : \mathcal{C}(D, T_1) \rightarrow \mathcal{C}(D, T_2)$ gives rise to a morphism of multiplicative unital representations.

Proof. By the base change to S it suffices to consider $S = R$. This will simplify the notation.

We first establish the statement without product structures. By construction, we can restrict to the case where the diagram D is finite.

Such a morphism of representations defines an element $\phi \in \text{Hom}(T_1, T_2)$, or, equivalently, an R -linear map $\phi^\vee : A_{1,2} \rightarrow R$. Conversely, $\phi \in \text{Hom}(T_1, T_2)$ is a morphism of representations.

Let $\Phi : \mathcal{C}(D, T_1) \rightarrow \mathcal{C}(D, T_2)$ be an S -linear functor. By composing with the universal representations \tilde{T}_1 and \tilde{T}_2 we obtain a morphism of representations $T_1 \otimes_R S \rightarrow T_2 \otimes_R S$.

Finally, compatibility with the product structure translates into multiplicativity of the map ϕ . \square

Remark 8.4.6. It does *not* follow that a morphism of representations gives rise to a functor between categories. Indeed, a linear map $V_1 \rightarrow V_2$ does *not* give rise to an algebra homomorphism $\text{End}(V_2) \rightarrow \text{End}(V_1)$.

We translate the statements to geometric language.

Theorem 8.4.7. *Let R be a field or a Dedekind domain. Let D be a diagram with unital commutative product structure, $T_1, T_2 : D \rightarrow R\text{-Proj}$ two representations. Let $X_{1,2} = \text{Spec}(A_{1,2})$, $G_1 = \text{Spec}(A_1)$ and $G_2 = \text{Spec}(A_2)$. The scheme $X_{1,2}$ is faithfully flat over R unless it is empty.*

1. The monoid G_1 operates on $X_{1,2}$ from the left

$$\mu_1 : G_1 \times X_{1,2} \rightarrow X_{1,2}.$$

2. The monoid G_2 operates on $X_{1,2}$ from the right

$$\mu_2 : X_{1,2} \times G_2 \rightarrow X_{1,2}.$$

3. There is a natural morphism

$$X_{1,2} \times X_{2,1} \times X_{1,2} \rightarrow X_{1,2}.$$

Let S be a faithfully flat extension of R . The choice of a point $X_{1,2}(S)$ is equivalent to a morphism of representations $T_1 \otimes_R S \rightarrow T_2 \otimes_R S$.

Remark 8.4.8. It is possible for $X_{1,2}$ to be empty as we will see in the examples below.

Example 8.4.9. For the diagrams $D = \text{Pairs}$ or $D = \text{Good}$ introduced in Chapter 9 and the representations $T_1 = H_{\text{dR}}^*$ (de Rham cohomology) and $T_2 = H^*$ (singular cohomology) this is going to induce the operation of the motivic Galois group $G_{\text{mot}} = \text{Spec}(A_2)$ on the torsor $X = X_{1,2} = \text{Spec}(A_{1,2})$.

We formulate the main result on the comparison of representations. By a torsor we will mean a torsor in the *fpqc*-topology, see Definition 1.7.3. For background on torsors, see Section 1.7.

Theorem 8.4.10. *Let $R \rightarrow S$ be faithfully flat and*

$$\varphi : T_1 \otimes_R S \rightarrow T_2 \otimes_R S$$

an isomorphism of unital multiplicative representations.

1. Then there is a $\phi \in X_{1,2}(S)$ such that the induced maps

$$\begin{aligned} G_{1,S} &\rightarrow X_{1,2,S}, & g &\mapsto \mu(g\phi) \\ G_{2,S} &\rightarrow X_{1,2,S}, & g &\mapsto \mu(\phi g) \end{aligned}$$

are isomorphisms.

2. This map ϕ induces an equivalence of unital tensor categories

$$\Phi : \mathcal{C}(D, T_1) \rightarrow \mathcal{C}(D, T_2).$$

3. The comparison algebra $A_{1,2}$ is canonically isomorphic, for the diagram D and the representations T_1 and T_2 , to the comparison algebra for the category $\mathcal{C} = \mathcal{C}(D, T_1)$ and the fibre functors f_{T_1} and $f_{T_2} \circ \Phi$.

Assume in addition that $\mathcal{C}(D, T_1)$ is rigid. Then:

4. $X_{1,2}$ is a G_1 -left torsor and a G_2 -right torsor in the fpqc-topology.
5. For flat extensions $R \rightarrow S'$, all sections $\psi \in X_{1,2}(S')$ are isomorphisms of representations $T_1 \otimes_R S' \rightarrow T_2 \otimes_R S'$. The map $\psi \rightarrow \psi^{-1}$ defines an isomorphism of schemes $\iota : X_{1,2} \rightarrow X_{2,1}$.
6. $X_{1,2}$ is a torsor in the sense of Definition 1.7.9 with structure map given via $\iota : X_{1,2} \rightarrow X_{2,1}$ and Theorem 8.4.7 by

$$X_{1,2}^3 \cong X_{1,2} \times X_{2,1} \times X_{1,2} \rightarrow X_{1,2}.$$

Moreover, the groups attached to $X_{1,2}$ via Proposition 1.7.10 are G_1 and G_2 .

Proof. 1. The first statement over S follows directly from the definitions.

2. We obtain the functor and its inverse by applying the universal property of the diagram categories in the general form of Corollary 7.1.15. They are inverse to each other by the uniqueness part of the universal property.

3. We use the notation $A(D, T_1, T_2)$ for the comparison algebra $A_{1,2}$ constructed in Definition 8.4.2. By definition,

$$A(D, T_1, T_2) = A(D, f_{T_1} \circ \tilde{T}_1, f_{T_2} \circ \Phi \circ \tilde{T}_1).$$

The map of diagrams $\tilde{T}_1 : D \rightarrow \mathcal{C} = \mathcal{C}(D, T_1)$ defines an algebra homomorphism

$$A(D, T_1, T_2) \rightarrow A(\mathcal{C}, f_{T_1}, f_{T_2} \circ \Phi)$$

by the same argument as in the proof of Lemma 7.2.6. We check that it is an isomorphism after the base change to S . Over S , we may use the isomorphism ϕ to replace $T_2 \otimes_R S$ by the isomorphic $T_1 \otimes_R S$. The claim now follows from the isomorphism

$$A(D, T_1 \otimes_R S) \rightarrow A(\mathcal{C}(D, T_1), f_{T_1})$$

which is the main content of Theorem 7.1.20 on the diagram category of an abelian category.

4. Now suppose in addition that $\mathcal{C}(D, T_1)$ is rigid. By the equivalence, this implies that $\mathcal{C}(D, T_2)$ is rigid. This means that the monoids G_1 and G_2 are group schemes. The first property translates into $X_{1,2}$ being a G_1 -left and G_2 -right torsor in the *fqc*-topology.

5. Let $\psi : T_1 \otimes_R S' \rightarrow T_2 \otimes_R S'$ be a morphism of representations. We claim that it is an isomorphism. This can be checked after a base change to S . Then T_2 becomes isomorphic to T_1 via φ and we may replace T_2 by T_1 in the argument. The morphism ψ can now be identified with a section $\psi \in G_1(S' \otimes_R S)$. This is a group, hence it has an inverse, which can be interpreted as the inverse of the morphism of representations.

6. Consider $X_{1,2}^3 \rightarrow X_{1,2}$ as defined in the theorem. We claim that it satisfies the torsor identities of Definition 1.7.9. This can be checked after the base change to S where we can replace $X_{1,2}$ by G_1 . The map is then given by

$$G_1^3 \rightarrow G_1, \quad (a, b, c) \mapsto ab^{-1}c$$

which is the trivial torsor. In particular, the left group defined by the torsor $X_{1,2}$ is nothing but G_1 . The same argument also applies to G_2 . \square

Remark 8.4.11. See also the discussion of the Tannakian case in Section 7.1.4. In this case, $X_{1,2}$ is the G -torsor of isomorphisms between the fibre functors T_1 and T_2 of [DM82, Theorem 3.2], see also Theorem 8.4.19. The above theorem is more general as it starts out with a commutative diagram instead of a rigid category. However, it is also weaker as it uses the existence of a point.

8.4.2 Some examples

We make the above theory explicit in a number of simple examples. The aim is to understand the conditions needed in order to ensure that $X_{1,2}$ is a torsor. It will turn out that rigidity of the diagram category is not enough.

Example 8.4.12. We reconsider Example 8.1.7. Let k be a field. The diagram is \mathbb{N}_0 with only edges $\text{id}_a \times \alpha_{v,w} \times \text{id}_b$. It carries a commutative product structure as before.

Let V_1 and V_2 be finite-dimensional k -vector spaces. Let $T_i : n \mapsto V_i^{\otimes n}$ be the multiplicative representations as before. We have shown that $G_i = \text{End}(V_i)$ as an algebraic k -scheme. The same argument yields

$$X_{1,2} = \text{Hom}_k(V_1, V_2)$$

as an algebraic k -scheme with the natural left and right operations by G_i .

Example 8.4.13. We reconsider again Example 8.3.7. We have $D = \mathbb{N}_0$ with additional edges generated from an extra edge $b : 2 \rightarrow 0$. Let (V_i, b_i) be finite-dimensional vector spaces with non-degenerate bilinear forms. We obtain

$$X_{1,2} = \text{Isom}((V_1, b_1), (V_2, b_2)),$$

the space of linear maps compatible with the forms, i.e., the space of isometries. In this case G_1 and G_2 are algebraic groups, indeed the orthogonal groups of b_1 and b_2 , respectively. The diagram categories are rigid.

We claim that $X_{1,2} = \emptyset$ if $\dim V_2 < \dim V_1$. The argument can already be explained in the case $V_1 = k^2$, $V_2 = k$ both with the standard scalar product. If $X_{1,2} \neq \emptyset$, there would be a K -valued point for some field extension K/k . This would mean the existence of a linear map $K^2 \rightarrow K$ with matrix (a, b) such that $a^2 = 1$, $b^2 = 1$ and $ab = 0$. This is impossible. We can write down the same argument in terms of equations: the algebra $A_{1,2}$ is generated by X, Y subject to the equations $X^2 - 1, Y^2 - 1, XY$. This implies $0 = 1$ in $A_{1,2}$.

On the other hand, if $\dim V_1 < \dim V_2$, then $X_{1,2} \neq \emptyset$. Nevertheless, the groups G_1, G_2 are not isomorphic over any field extension of k . Hence $X_{1,2}$ is *not* a torsor. This is in contrast with the Tannakian case. Note that the points of $X_{1,2}$ do not give rise to functors — they would be tensor functors and hence isomorphisms.

The example shows the following:

Corollary 8.4.14. *There is a diagram D with unital commutative product structure and a pair of unital multiplicative representations T_1, T_2 such that the resulting tensor categories are both rigid, but non-equivalent.*

Example 8.4.15. We resume the situation of Example 8.4.13, but with $\dim V_1 = \dim V_2$. The two spaces become isometric over \bar{k} because any two non-degenerate bilinear forms are equivalent over the algebraic closure. By Theorem 8.4.10, $X_{1,2}$ is a torsor and the two diagram categories are equivalent. Hence the categories of representations of all orthogonal groups of the same dimension are equivalent. Note that we are considering algebraic k -representations of k -algebraic groups here.

Example 8.4.16. We consider another variant of Example 8.3.7. Let $D = \mathbb{N}_0$ with edges

$$\begin{aligned} \text{id}_n \times \alpha_{v,w} \times \text{id}_n &: n + v + w + m \rightarrow n + v + w + m \\ \text{id}_n \times b \times \text{id}_m &: n + 2 + m \rightarrow n + m \\ \text{id}_n \times b' \times \text{id}_m &: n + m \rightarrow n + 2 + m \end{aligned}$$

with identifications $\text{id}_n \times \alpha_{0,0} \times \text{id}_m = \text{id}_{n+m}$, as before. We use again the trivial grading and the obvious commutative product structure with all $\beta_{u,v,w}$ and $\beta'_{u,v,w}$ given by the identity.

Let (V, b) be a finite-dimensional k -vector space with a non-degenerate bilinear form $V^{\otimes 2} \rightarrow k$. We define a multiplicative representation $n \mapsto V^{\otimes n}$ which assigns the form b to the edge b and the dual of b to the edge b' .

As in the case of Example 8.3.7, the category $\mathcal{C}(D, T)$ is the category of representations of the group $O(b)$. The algebra is not changed because the additional relations for b' are automatic.

If we have two such representations attached to (V_1, b_1) and (V_2, b_2) then $X_{1,2}$ is either empty (if $\dim V_1 \neq \dim V_2$) or an $O(b_1)$ -torsor (if $\dim V_1 = \dim V_2$). The additional edge b' forces any morphism of representations to be an isomorphism.

We formalise this.

Lemma 8.4.17. *Let D be a graded diagram with a commutative product structure. Let $T_1, T_2 : D \rightarrow R\text{-Mod}$ be multiplicative representations. Suppose that for every vertex v there is a vertex w and a pair of edges $e_v : v \times w \rightarrow \mathbf{1}$ and $e'_v : \mathbf{1} \rightarrow v \times w$ such that $T_i(e_v)$ is a non-degenerate bilinear map and $T_i(e'_v)$ its dual.*

Let $R \rightarrow S$ be faithfully flat. Then every morphism of representations

$$\phi : T_1 \otimes_R S \rightarrow T_2 \otimes_R S$$

is an isomorphism. Hence Proposition 8.4.10 applies in this case.

Remark 8.4.18. As Example 8.4.16 has shown, the space $X_{1,2}$ may still be empty!

Proof. Let v be an edge. Compatibility with e_v forces the map $T_1(v) \otimes S \rightarrow T_2(v) \otimes S$ to be injective. Compatibility with e'_v forces it to be surjective, hence bijective. \square

This applies in particular in the Tannakian case. Moreover, in this case $X_{1,2}$ is non-empty.

Theorem 8.4.19 (The Tannakian case). *Let k be a field, \mathcal{C} a rigid tensor category. Let $F_1, F_2 : \mathcal{C} \rightarrow k\text{-Mod}$ be two faithful fibre functors with associated groups G_1 and G_2 .*

1. *Let S be a k -algebra and let*

$$\phi : F_1 \otimes S \rightarrow F_2 \otimes S$$

be a morphism of tensor functors. Then ϕ is an isomorphism.

2. *$X_{1,2}$ is non-empty and a G_1 -left and G_2 -right torsor.*

This is [DM82, Proposition 1.9] and [DM82, Theorem 3.2]. We give the proof directly in our notation.

Proof. For the first statement, simply apply Proposition 8.4.17 to the diagram defined by \mathcal{C} .

We now consider $X_{1,2}$ and need to show that the natural map $k \rightarrow A_{1,2}$ is injective. As in the proof of Theorem 7.1.20, we can write $\mathcal{C} = 2\text{-colim}\{p\}$ where p runs through all objects of \mathcal{C} and $\{p\}$ means the full subcategory with only object p . (In general we would consider finite subdiagrams F , but in the abelian case we can replace F by the direct sum of its objects.) Hence

$$A_1 = \lim A(\{p\}, T_1), A_{1,2} = \lim A(\{p\}, T_1, T_2).$$

Without loss of generality we assume that $\mathbf{1}$ is a direct summand of p .

We check that injectivity holds on the level of $\langle p \rangle$ (the abelian category generated by p) instead of $\{p\}$. Let $X(p) \subset \text{Hom}_R(T_1(p), p)$ be the object constructed in Lemma 7.3.16. By loc. cit.

$$T_1(X(p)) = \text{End}(T_1|_p) = A(p, T_1)^\vee.$$

The same arguments show that

$$T_2(X(p)) = \text{Hom}(T_1|_p, T_2|_p) = A(\langle p \rangle, T_1, T_2).$$

The splitting of p induces a morphism

$$X(p) \rightarrow \text{Hom}_R(T_1(p), p) \rightarrow \text{Hom}_R(T_1(\mathbf{1}), \mathbf{1}) = \mathbf{1}.$$

Applying T_1 gives the map

$$A(\{p\}, T_1)^\vee \rightarrow k$$

defining the unit element of A_1 . It is surjective. As T_1 is faithful, this implies that $X(p) \rightarrow \mathbf{1}$ is surjective. By applying the faithful functor T_2 we get a surjection

$$A(\{p\}, T_1, T_2)^\vee \rightarrow \text{Hom}_k(T_1(\mathbf{1}), T_2(\mathbf{1})) = k.$$

This is the map defining the unit of $A_{1,2}$. Hence $k \rightarrow A_{1,2}$ is injective. \square

8.4.3 The description as formal periods

For later use, we give an alternative description of the same algebra.

Definition 8.4.20. Let D be a diagram and let $T_1, T_2 : D \rightarrow R\text{-Proj}$ be representations. We define the space of *formal periods* $P_{1,2}$ as the R -module generated by symbols

$$(p, \omega, \gamma)$$

where p is a vertex of D , $\omega \in T_1 p$, $\gamma \in T_2 p^\vee$ with the following relations:

1. (linearity in ω, γ) for all $p \in D$, $\omega_1, \omega_2 \in T_1 p$, $\lambda_1, \lambda_2 \in R$, $\gamma \in T_2 p^\vee$

$$(p, \lambda_1\omega_1 + \lambda_2\omega_2, \gamma) = \lambda_1(p, \omega_1, \gamma) + \lambda_2(p, \omega_2, \gamma)$$

and for all $p \in D$, $\omega \in T_1p$, $\gamma_1, \gamma_2 \in T_2p^\vee$, $\mu_1, \mu_2 \in R$

$$(p, \lambda, \mu_1\gamma_1 + \mu_2\gamma_2) = \mu_1(p, \lambda, \gamma_1) + (p, \lambda, \gamma_2);$$

2. (functoriality) If $f : p \rightarrow p'$ is an edge in D , $\gamma \in T_2p'^\vee$, $\omega \in T_1p$, then

$$(p', (T_1f)(\omega), \gamma) = (p, \omega, (T_2f)^\vee(\gamma)).$$

Proposition 8.4.21. *Assume D has a unital commutative product structure and T_1, T_2 are unital multiplicative representations. Then $P_{1,2}$ is a commutative R -algebra with multiplication given on generators by*

$$(p, \omega, \gamma)(p', \omega', \gamma') = (p \times p', \omega \otimes \omega', \gamma \otimes \gamma').$$

Proof. It is obvious that the relations of $P_{1,2}$ are respected by the formula. \square

There is a natural transformation

$$\Psi : P_{1,2} \rightarrow A_{1,2}$$

defined as follows: let $(p, \omega, \gamma) \in P_{1,2}$. Let F be a finite diagram containing p . Then

$$\Psi(p, \omega, \gamma) \in A_{1,2}(F) = \text{Hom}(T_1|_F, T_2|_F)^\vee$$

is the map

$$\text{Hom}(T_1|_F, T_2|_F) \rightarrow R$$

which maps $\phi \in \text{Hom}(T_1|_F, T_2|_F)$ to $\gamma(\phi(p)(\omega))$. Clearly, this is independent of F and respects the relations of $P_{1,2}$.

Theorem 8.4.22. *Let D be a diagram. Then the above map*

$$\Psi : P_{1,2} \rightarrow A_{1,2}$$

is an isomorphism. If D carries a commutative product structure and T_1, T_2 are graded multiplicative representations, then it is an isomorphism of R -algebras.

Proof. For a finite subdiagram $F \subset D$, let $P_{1,2}(F)$ be the space of periods. By definition, $P_{1,2} = \text{colim}_F P_{1,2}(F)$. The statement is compatible with these direct limits. Hence, without loss of generality, $D = F$ is finite.

By definition, $P_{1,2}(D)$ is the submodule of

$$\prod_{p \in D} T_1p \otimes T_2p^\vee$$

of elements satisfying the relations induced by the edges of D . By definition, $A_{1,2}(D)$ is the submodule of

$$\prod_{p \in D} \text{Hom}(T_1 p, T_2 p)^\vee$$

of elements satisfying the relations induced by the edges of D . As all $T_i p$ are locally free and of finite rank, this is the same thing.

The compatibility with products is easy to see. \square

Remark 8.4.23. The theorem is also of interest in the case $T = T_1 = T_2$. It then gives an explicit description of Nori's coalgebra by generators and relations. We have implicitly used the description in some of the examples.

Definition 8.4.24. Let D be a diagram with a unital commutative product structure. Let $T_1, T_2 : D \rightarrow R\text{-Proj}$ be unital multiplicative representations and let p be a vertex of D . We choose a basis $\omega_1, \dots, \omega_n$ of $T_1 p$ and a basis $\gamma_1, \dots, \gamma_n$ of $(T_2 p)^\vee$. We call

$$P_{ij} = ((p, \omega_i, \gamma_j))_{i,j}$$

the *formal period matrix* at p .

We will later discuss this point of view systematically.

Proposition 8.4.25. *Let D be a diagram with a unital commutative product structure. Assume that there is a faithfully flat extension $R \rightarrow S$ and an isomorphism of representations $\varphi : T_1 \otimes S \rightarrow T_2 \otimes S$. Moreover, assume that $\mathcal{C}(D, T_1)$ is rigid. Then $X_{1,2} = \text{Spec}(P_{1,2})$ becomes a torsor in the sense of Definition 1.7.9 with structure map*

$$P_{1,2} \rightarrow P_{1,2}^{\otimes 3}$$

given by

$$P_{ij} \mapsto \sum_{k,\ell} P_{ik} \otimes P_{k\ell}^{-1} \otimes P_{\ell j}.$$

Proof. We use Theorem 8.4.22 to translate Theorem 8.4.10 into the alternative description. \square

Chapter 9

Nori motives

We describe Nori's construction of an abelian category of motives. It is defined as the diagram category (see Chapters 7 and 8) of a certain diagram. It is universal for all cohomology theories that can be compared with singular cohomology. In the first section, we give the definition of the abelian category of Nori motives and summarise the results. We then compare it to an alternative description using the Basic Lemma. This will then allow us to define the tensor structure. Loose ends will be collected at the end.

9.1 Essentials of Nori motives

As before, we denote by $\mathbb{Z}\text{-Mod}$ the category of finitely generated \mathbb{Z} -modules and $\mathbb{Z}\text{-Proj}$ the category of finitely generated free \mathbb{Z} -modules.

9.1.1 Definition

Let k be a subfield of \mathbb{C} . For a variety X over k , we define singular cohomology of X as singular cohomology of the analytic space $(X \times_k \mathbb{C})^{\text{an}}$. As in Chapter 2.1, we denote it simply by $H^i(X, \mathbb{Z})$.

Definition 9.1.1. Let k be a subfield of \mathbb{C} . The diagram $\text{Pairs}^{\text{eff}}$ of *effective pairs* consists of triples (X, Y, i) with X a k -variety, $Y \subset X$ a closed subvariety and an integer i . There are two types of edges between effective pairs:

1. (functoriality) For every morphism $f : X \rightarrow X'$ with $f(Y) \subset Y'$ an edge

$$f^* : (X', Y', i) \rightarrow (X, Y, i).$$

2. (coboundary) For every chain $X \supset Y \supset Z$ of closed k -subschemes of X an edge

$$\partial : (Y, Z, i) \rightarrow (X, Y, i + 1).$$

The diagram has identities in the sense of Definition 7.1.1 given by the identity morphism. The diagram is graded in the sense of Definition 8.1.3 by $|(X, Y, i)| = i \pmod 2$.

Proposition 9.1.2. *The assignment*

$$H^* : \text{Pairs}^{\text{eff}} \rightarrow \mathbb{Z}\text{-Mod}$$

which maps (X, Y, i) to relative singular cohomology $H^i(X(\mathbb{C}), Y(\mathbb{C}); \mathbb{Z})$ is a representation in the sense of Definition 7.1.4. It maps $(\mathbb{G}_m, \{1\}, 1)$ to \mathbb{Z} .

Proof. Relative singular cohomology was defined in Definition 2.1.1. By definition, it is contravariantly functorial. This defines H^* on edges of type 1. The connecting morphism for triples, see Corollary 2.1.5, defines the representation on edges of type 2. We compute $H^1(\mathbb{G}_m, \{1\}, \mathbb{Z})$ via the sequence for relative cohomology

$$H^0(\mathbb{C}^*, \mathbb{Z}) \rightarrow H^0(\{1\}, \mathbb{Z}) \rightarrow H^1(\mathbb{C}^*, \{1\}, \mathbb{Z}) \rightarrow H^1(\mathbb{C}^*, \mathbb{Z}) \rightarrow H^1(\{1\}, \mathbb{Z}).$$

The first map is an isomorphism. The last group vanishes for dimension reasons. Finally, $H^1(\mathbb{C}^*, \mathbb{Z}) \cong \mathbb{Z}$ because \mathbb{C}^* is homotopy equivalent to the unit circle. \square

Definition 9.1.3. 1. The category of *effective mixed Nori motives*

$$\mathcal{MM}_{\text{Nori}}^{\text{eff}} := \mathcal{MM}_{\text{Nori}}^{\text{eff}}(k)$$

is defined as the diagram category $\mathcal{C}(\text{Pairs}^{\text{eff}}, H^*)$ from Theorem 7.1.13.
2. For an effective pair (X, Y, i) , we write $H_{\text{Nori}}^i(X, Y)$ for the corresponding object in $\mathcal{MM}_{\text{Nori}}^{\text{eff}}$. We put

$$\mathbf{1}(-1) = H_{\text{Nori}}^1(\mathbb{G}_m, \{1\}) \in \mathcal{MM}_{\text{Nori}}^{\text{eff}},$$

the *Lefschetz motive*.

3. The category $\mathcal{MM}_{\text{Nori}} = \mathcal{MM}_{\text{Nori}}(k)$ of *mixed Nori motives* is defined as the localisation of $\mathcal{MM}_{\text{Nori}}^{\text{eff}}$ with respect to $\mathbf{1}(-1)$.
4. We also write H^* for the extension of H^* to $\mathcal{MM}_{\text{Nori}}$.

Remark 9.1.4. This is equivalent to Nori's original definition by Theorem 9.3.4.

9.1.2 Main results

Theorem 9.1.5 (Nori). 1. $\mathcal{MM}_{\text{Nori}}^{\text{eff}}$ has a natural structure of a commutative tensor category with unit such that H^* is a tensor functor.

2. $\mathcal{MM}_{\text{Nori}}$ is a rigid tensor category.
3. $\mathcal{MM}_{\text{Nori}}$ is equivalent to the category of representations of a faithfully flat pro-algebraic group scheme $G_{\text{mot}}(k, \mathbb{Z})$ over \mathbb{Z} .

For the proof, see Section 9.3.1.

Remark 9.1.6. It is an open question whether $\mathcal{MM}_{\text{Nori}}^{\text{eff}}$ is a full subcategory of $\mathcal{MM}_{\text{Nori}}$, or equivalently, if $-\otimes \mathbf{1}(-1)$ is full on $\mathcal{MM}_{\text{Nori}}^{\text{eff}}$.

Definition 9.1.7. The group scheme $G_{\text{mot}}(k, \mathbb{Z})$ is called the *motivic Galois group in the sense of Nori*. Its base change to \mathbb{Q} is denoted by $G_{\text{mot}}(k, \mathbb{Q})$ or $G_{\text{mot}}(k)$ for short.

Remark 9.1.8. The first statement of Theorem 9.1.5 also holds with the coefficient ring \mathbb{Z} replaced by any noetherian ring R . The other two hold if R is a Dedekind ring or a field. Of particular interest is the case $R = \mathbb{Q}$.

The proof of this theorem will occupy the rest of the chapter. We now explain the key ideas. In order to define the tensor structure, we would like to apply the abstract machine developed in Section 8.1. However, the shape of the Künneth formula

$$H^n(X \times Y, \mathbb{Q}) \cong \bigoplus_{i+j=n} H^i(X, \mathbb{Q}) \otimes H^j(Y, \mathbb{Q})$$

is not of the required kind. Nori introduces a subdiagram of *good pairs* where relative cohomology is concentrated in a single degree and free, so that the Künneth formula simplifies even integrally. The key insight now becomes that it is possible to recover *all* pairs from good pairs. This is done via an algebraic skeletal filtration constructed from the Basic Lemma as discussed in Section 2.5. As a byproduct, we will also see that $\mathcal{MM}_{\text{Nori}}^{\text{eff}}$ and $\mathcal{MM}_{\text{Nori}}$ are given as representations of a monoid scheme. In the next step, we have to verify *rigidity*, i.e., we have to show that the monoid is an algebraic group. We do this by verifying the abstract criterion of Section 8.3.

On the way, we need to establish a general “motivic” property of Nori motives.

Theorem 9.1.9. *There is a natural contravariant triangulated functor*

$$R : K^b(\mathbb{Z}[\text{Var}]) \rightarrow D^b(\mathcal{MM}_{\text{Nori}}^{\text{eff}})$$

on the homotopy category of bounded homological complexes in $\mathbb{Z}[\text{Var}]$ such that for every effective pair (X, Y, i) we have

$$H^i(R(\text{Cone}(Y \rightarrow X))) = H_{\text{Nori}}^i(X, Y).$$

For the proof, see Section 9.3.1. The theorem allows us, for example, to define motives of simplicial varieties or motives with support.

The category of motives is supposed to be the universal abelian category such that all cohomology theories with suitable properties factor via the category of motives. We do not yet have such a theory, even though it is reasonable to conjecture that $\mathcal{MM}_{\text{Nori}}$ is the correct description. In any case, it does have a universal property which is good enough for many applications.

Theorem 9.1.10 (Universal property). *Let \mathcal{A} be an abelian category with a faithful exact functor $f : \mathcal{A} \rightarrow R\text{-Mod}$ for a noetherian ring R flat over \mathbb{Z} . Let*

$$H'^* : \text{Pairs}^{\text{eff}} \rightarrow \mathcal{A}$$

be a representation. Assume that there is an extension $R \rightarrow S$ such that S is faithfully flat over R and an isomorphism of representations

$$\Phi : H_S^* \rightarrow (f \circ H'^*)_S.$$

Then H'^ extends to $\mathcal{MM}_{\text{Nori}}$. More precisely, there exists a functor $L(H'^*) : \mathcal{MM}_{\text{Nori}} \rightarrow \mathcal{A}[H'(\mathbf{1}(-1))]^{-1}$ and an isomorphism of functors*

$$\tilde{\Phi} : (f_{H^*})_S \rightarrow f_S \circ L(H'^*)$$

such that

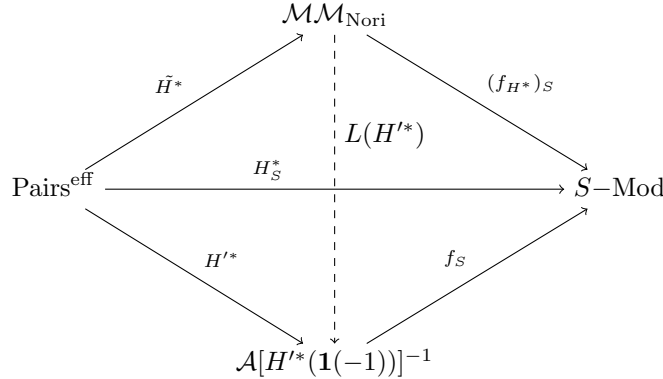

commutes up to Φ and $\tilde{\Phi}$. The pair $(L(H'^), \tilde{\Phi})$ is unique up to unique isomorphism of functors.*

If, moreover, \mathcal{A} is a tensor category, f a tensor functor and H'^ a graded multiplicative representation on Good^{eff} , then $L(H'^*)$ is a tensor functor and $\tilde{\Phi}$ is an isomorphism of tensor functors.*

For the proof, see Section 9.3.1. This means that $\mathcal{MM}_{\text{Nori}}$ is universal for all cohomology theories with a comparison isomorphism to singular cohomology. Actually, it suffices to have a representation of Good^{eff} or $\text{VGood}^{\text{eff}}$, see Definition 9.2.1.

Example 9.1.11. Let $R = k$, $\mathcal{A} = k\text{-Mod}$, H'^* be algebraic de Rham cohomology, see Chapter 3. Let $S = \mathbb{C}$, and let the comparison isomorphism

Φ be the period isomorphism of Chapter 5. By the universal property, de Rham cohomology extends to $\mathcal{MM}_{\text{Nori}}$. We will study this example in a lot more detail in Part III in order to understand the period algebra.

Example 9.1.12. Let $R = \mathbb{Z}$, \mathcal{A} be the category of mixed \mathbb{Z} -Hodge structures, and H'^* the functor assigning a mixed Hodge structure to a variety or a pair. Then $S = \mathbb{Z}$ and Φ is the functor mapping a Hodge structure to the underlying \mathbb{Z} -module. By the universal property, H'^* factors canonically via $\mathcal{MM}_{\text{Nori}}$. In other words, motives define mixed Hodge structures.

Example 9.1.13. Let ℓ be a prime, $R = \mathbb{Z}_\ell$, and \mathcal{A} be the category of finitely generated \mathbb{Z}_ℓ -modules with a continuous operation of $\text{Gal}(\bar{k}/k)$. Let H'^* be ℓ -adic cohomology over \bar{k} . For X a variety and $Y \subset X$ a closed subvariety with open complement $j : U \rightarrow X$, we have

$$(X, Y, i) \mapsto H_{et}^i(X_{\bar{k}}, j_*\mathbb{Z}_\ell).$$

In this case, we let $S = \mathbb{Z}_\ell$ and use the comparison isomorphism between ℓ -adic and singular cohomology. By the universal property, ℓ -adic cohomology extends to Nori motives.

Corollary 9.1.14. *The category $\mathcal{MM}_{\text{Nori}}$ is independent of the choice of embedding $\sigma : k \rightarrow \mathbb{C}$. More precisely, let $\sigma' : k \rightarrow \mathbb{C}$ be another embedding. Let H'^* be singular cohomology with respect to this embedding. Then there is an equivalence of categories*

$$\mathcal{MM}_{\text{Nori}}(\sigma) \rightarrow \mathcal{MM}_{\text{Nori}}(\sigma').$$

Proof. Use $S = \mathbb{Z}_\ell$ and the comparison isomorphism given by comparing both singular cohomology functors with ℓ -adic cohomology. This induces the functor. \square

Remark 9.1.15. Note that the equivalence is *not* canonical. In the argument above it depends on the choice of embeddings of \bar{k} into \mathbb{C} extending σ and σ' , respectively. If we are willing to work with rational coefficients instead, we can compare both singular cohomologies with algebraic de Rham cohomology (with $S = k$). This gives a compatible system of comparison equivalences.

Base change defines a functor on Nori motives. Of particular interest is the case of the algebraic closure. We restrict to rational coefficients at this point.

Theorem 9.1.16. *Let k be field with algebraic closure \bar{k} . Fix an embedding $\bar{k} \rightarrow \mathbb{C}$. Then there is a natural exact sequence*

$$1 \rightarrow G_{\text{mot}}(\bar{k}, \mathbb{Q}) \rightarrow G_{\text{mot}}(k, \mathbb{Q}) \rightarrow \text{Gal}(\bar{k}/k) \rightarrow 1.$$

The proof of this theorem will be given in Section 9.5.

9.2 Yoga of good pairs

We now turn to alternative descriptions of $\mathcal{MM}_{\text{Nori}}^{\text{eff}}$ better suited to the tensor structure.

9.2.1 Good pairs and good filtrations

Definition 9.2.1. Let k be a subfield of \mathbb{C} .

1. The diagram Good^{eff} of *effective good pairs* is the full subdiagram of $\text{Pairs}^{\text{eff}}$ with vertices the triples (X, Y, i) such that singular cohomology satisfies

$$H^j(X, Y; \mathbb{Z}) = 0, \text{ unless } j = i,$$

and is free for $j = i$.

2. The diagram $\text{VGood}^{\text{eff}}$ of *effective very good pairs* is the full subdiagram of those effective good pairs (X, Y, i) with X affine, $X \setminus Y$ smooth and either X of dimension i and Y of dimension $i - 1$, or $X = Y$ of dimension less than i .

Remark 9.2.2. In Definition 9.3.2 we will also introduce the diagrams Pairs of *pairs*, Good of *good pairs* and VGood of *very good pairs* as localisations (in the sense of Definition 8.2.1) with respect to $(\mathbb{G}_m, \{1\}, 1)$. We do not yet need them.

Good pairs exist in abundance by the Basic Lemma, see Theorem 2.5.2.

Our first aim is to show that the diagram categories attached to $\text{Pairs}^{\text{eff}}$, Good^{eff} and $\text{VGood}^{\text{eff}}$ are equivalent. By the general principles of diagram categories this means that we have to represent the diagram $\text{Pairs}^{\text{eff}}$ in $\mathcal{C}(\text{VGood}^{\text{eff}}, H^*)$. We do this in two steps: first a general variety is replaced by the Čech complex attached to an affine cover; then affine varieties are replaced by complexes of very good pairs using the key idea of Nori. The construction proceeds in a complicated way because both steps involve choices which have to be made in a compatible way. We handle this problem in the same way as in [Hub04].

We start in the affine case. Using induction, one gets from the Basic Lemma 2.5.2:

Proposition 9.2.3. *Every affine variety X has a filtration*

$$\emptyset = F_{-1}X \subset F_0X \subset \cdots \subset F_{n-1}X \subset F_nX = X$$

such that $(F_jX, F_{j-1}X, j)$ is very good.

Filtrations of the above type are called *very good filtrations*.

Proof. Let $\dim X = n$. Put $F_n X = X$. Choose a subvariety of dimension $n - 1$ which contains all singular points of X . By the Basic Lemma 2.5.2, there is a subvariety $F_{n-1} X$ of dimension $n - 1$ such that $(F_n X, F_{n-1} X, n)$ is good. By construction, $F_n X \setminus F_{n-1} X$ is smooth and hence the pair is very good. We continue by induction. In the case $n = 0$, there is nothing to do because we are in characteristic zero. \square

Corollary 9.2.4. *Let X be an affine variety. The inductive system of all very good filtrations of X is filtered and functorial. This means in detail:*

1. for any two very good filtrations $F_\bullet X$ and $F'_\bullet X$ there is a very good filtration $G_\bullet X$ such that $F_\bullet X \subset G_\bullet X$ and $F'_\bullet X \subset G_\bullet X$;
2. if $f : X \rightarrow X'$ is a morphism and $F_\bullet X$ a very good filtration, then there is a very good filtration $F_\bullet X'$ such that $f(F_\bullet X) \subset F_\bullet X'$.

Proof. Let $F_\bullet X$ and $F'_\bullet X$ be two very good filtrations of X . Let $n \leq \dim X$. Then $F_{n-1} X \cup F'_{n-1} X$ has dimension $n - 1$. By the Basic Lemma 2.5.2, there is subvariety $G_{n-1} X \subset X$ of dimension $n - 1$ such that $(X, G_{n-1} X, n)$ is a good pair. It is automatically very good. We continue by induction.

Consider a morphism $f : X \rightarrow X'$. Let $F_\bullet X$ be a very good filtration. Then $f(F_i X)$ has dimension at most i . As in the proof of Corollary 9.2.3, we construct a very good filtration $F_\bullet X'$ with the additional property $f(F_i X) \subset F_i X'$. \square

Remark 9.2.5. This allows us to construct a functor from the category of affine varieties to the diagram category $\mathcal{C}(\text{VGood}^{\text{eff}}, H^*)$ as follows: Given an affine variety X , let $F_\bullet X$ be a very good filtration. The boundary maps of the triples $F_{i-1} X \subset F_i X \subset F_{i+1} X$ define a complex in $\mathcal{C}(\text{VGood}^{\text{eff}}, H^\bullet)$

$$\cdots \rightarrow H_{\text{Nori}}^i(F_i X, F_{i-1} X) \rightarrow H_{\text{Nori}}^{i+1}(F_{i+1} X, F_i X) \rightarrow \cdots,$$

see the corresponding topological statement in Corollary 2.3.13. Taking the i -th cohomology of this complex defines an object in $\mathcal{C}(\text{VGood}^{\text{eff}}, H^*)$ whose underlying \mathbb{Z} -module is nothing but singular cohomology $H^i(X, \mathbb{Z})$. Up to isomorphism, it is independent of the choice of filtration. In particular, it is functorial.

We are going to refine the above construction in order to apply it to complexes of varieties.

9.2.2 Čech complexes

The next step is to replace arbitrary varieties by affine varieties by replacing a variety by the Čech complex of an affine cover. The problem with this approach is that morphisms of covers are *not* unique and the system of all open covers is *not* filtered.

Example 9.2.6. Let X be an affine variety. Consider the covers $\{X_i\}_{i \in \{1,2\}}$ with $X_i = X$ and $\{X_j\}_{j \in \{1\}}$ with $X_j = X$. There are two obvious maps from the second cover to the first. They are not equalized on any refinement.

The Čech complexes are unique up to simplicial homotopy. This is enough to make their cohomology canonical. It is, however, not enough for what we want to do: extend to Čech complexes of complexes of varieties and take total complexes of double complexes. We rectify the problem by using rigidifications, an idea found in [Fri82, Definition 4.2] for the case of étale coverings.

Definition 9.2.7. Let X be a variety. A *rigidified* affine cover is a finite open affine covering $\{U_i\}_{i \in I}$ together with the following choice: for every closed point $x \in X$ an index i_x such that $x \in U_{i_x}$. We also assume that every index $i \in I$ occurs as i_x for some $x \in X$.

Let $f : X \rightarrow Y$ be a morphism of varieties, $\{U_i\}_{i \in I}$ a rigidified open cover of X and $\{V_j\}_{j \in J}$ a rigidified open cover of Y . A *morphism* of rigidified covers (over f)

$$\phi : \{U_i\}_{i \in I} \rightarrow \{V_j\}_{j \in J}$$

is a map of sets $\phi : I \rightarrow J$ such that $f(U_i) \subset V_{\phi(i)}$ and we have $\phi(i_x) = j_{f(x)}$ for all $x \in X$.

Remark 9.2.8. The rigidification makes ϕ unique if it exists.

Lemma 9.2.9. *The projective system of rigidified affine covers is filtered and strictly functorial, i.e., if $f : X \rightarrow Y$ is a morphism of varieties, pull-back defines a map of projective systems.*

Proof. Any two covers have their intersection as common refinement with index set the product of the index sets. The rigidification extends in the obvious way. Preimages of rigidified covers are rigidified open covers. \square

We need to generalise this to complexes of varieties. Recall from Definition 1.1.1 the additive categories $\mathbb{Z}[\text{Aff}]$ and $\mathbb{Z}[\text{Var}]$ with objects (affine) varieties and morphisms roughly \mathbb{Z} -linear combinations of morphisms of varieties. The support of a morphism in $\mathbb{Z}[\text{Var}]$ is the set of morphisms occurring in the linear combination.

Definition 9.2.10. Let X_\bullet be a homological complex of varieties, i.e., an object in $C_b(\mathbb{Z}[\text{Var}])$. An *affine cover* of X_\bullet is a complex of rigidified affine covers, i.e., for every X_n the choice of a rigidified open cover \tilde{U}_{X_n} and for every $g : X_n \rightarrow X_{n-1}$ in the support of the differential $X_n \rightarrow X_{n-1}$ in the complex X_\bullet a morphism of rigidified covers $\tilde{g} : \tilde{U}_{X_n} \rightarrow \tilde{U}_{X_{n-1}}$ over g .

Let $F_\bullet : X_\bullet \rightarrow Y_\bullet$ be a morphism in $C_b(\mathbb{Z}[\text{Var}])$ and $\tilde{U}_{X_\bullet}, \tilde{U}_{Y_\bullet}$ affine covers of X_\bullet and Y_\bullet . A morphism of affine covers over F_\bullet is a morphism of rigidified affine covers $f_n : \tilde{U}_{X_n} \rightarrow \tilde{U}_{Y_n}$ over every morphism in the support of F_n .

Lemma 9.2.11. *Let $X_\bullet \in C_b(\mathbb{Z}[\text{Var}])$. Then the projective system of rigidified affine covers of X_\bullet is non-empty, filtered and functorial, i.e., if $f_\bullet :$*

$X_\bullet \rightarrow Y_\bullet$ is a morphism of complexes and \tilde{U}_{X_\bullet} an affine cover of X_\bullet , then there is an affine cover \tilde{U}_{Y_\bullet} and a morphism of complexes of rigidified affine covers $\tilde{U}_{X_\bullet} \rightarrow \tilde{U}_{Y_\bullet}$. Any two choices are compatible in the projective system of covers.

Proof. Let n be minimal with $X_n \neq \emptyset$. Choose a rigidified cover of X_n . The support of $X_{n+1} \rightarrow X_n$ has only finitely many elements. Choose a rigidified cover of X_{n+1} compatible with all of them. Continue inductively.

Similar constructions prove the rest of the assertion. \square

Definition 9.2.12. Let X be a variety and $\tilde{U}_X = \{U_i\}_{i \in I}$ a rigidified affine cover of X . We put

$$C_\star(\tilde{U}_X) \in C_-(\mathbb{Z}[\text{Aff}]),$$

the Čech complex associated to the cover, i.e.,

$$C_n(\tilde{U}_X) = \prod_{i \in I_n} \bigcap_{i \in i} U_i,$$

where I_n is the set of tuples (i_0, \dots, i_n) . The boundary maps are given by the formula

$$d_n = \sum_{j=0}^n (-1)^j \partial_j : C_n(\tilde{U}_X) \rightarrow C_{n-1}(\tilde{U}_X)$$

with ∂_j on $\bigcap_{i \in (i_0, \dots, i_n)} U_i$ given by the open immersion into $\bigcap_{i \neq j} U_i$.

If $X_\bullet \in C_b(\mathbb{Z}[\text{Var}])$ is a complex, and \tilde{U}_{X_\bullet} a rigidified affine cover, let

$$C_\star(\tilde{U}_{X_\bullet}) \in C_{-,b}(\mathbb{Z}[\text{Aff}])$$

be the double complex $C_i(\tilde{U}_{X_j})$.

Note that all components of $C_\star(\tilde{U}_{X_\bullet})$ are affine. The projective system of these complexes is filtered and functorial.

Definition 9.2.13. Let X be a variety and $\tilde{U}_X = \{U_i\}_{i \in I}$ a rigidified affine cover of X . A *very good filtration* on \tilde{U}_X is the choice of very good filtrations for

$$\bigcap_{i \in I'} U_i$$

for all $I' \subset I$ compatible with all inclusions between these.

Let $f : X \rightarrow Y$ be a morphism of varieties and $\phi : \{U_i\}_{i \in I} \rightarrow \{V_j\}_{j \in J}$ a morphism of rigidified affine covers above f . Fix very good filtrations on both covers. The morphism ϕ is called *filtered* if, for all $I' \subset I$, the induced map

$$\bigcap_{i \in I'} U_i \rightarrow \bigcap_{i \in I'} V_{\phi(i)}$$

is compatible with the filtrations, i.e.,

$$f \left(F_{\bullet} \bigcap_{i \in I'} U_i \right) \subset F_{\bullet} \bigcap_{i \in I'} V_{\phi(i)}.$$

Let $X_{\bullet} \in C_b(\mathbb{Z}[\text{Var}])$ be a bounded complex of varieties and $\tilde{U}_{X_{\bullet}}$ an affine cover of X_{\bullet} . A *very good filtration* on $\tilde{U}_{X_{\bullet}}$ is a very good filtration on all the \tilde{U}_{X_n} compatible with all morphisms in the support of the boundary maps.

Note that the Čech complex associated to a rigidified affine cover with very good filtration is also filtered in the sense that there is a very good filtration on all the $C_n(\tilde{U}_X)$ and all morphisms in the support of the differential are compatible with the filtrations.

Lemma 9.2.14. *Let X be a variety and \tilde{U}_X a rigidified affine cover. Then the inductive system of very good filtrations on \tilde{U}_X is non-empty, filtered and functorial.*

The same statement also holds for a complex of varieties $X_{\bullet} \in C_b(\mathbb{Z}[\text{Var}])$.

Proof. Let $\tilde{U}_X = \{U_i\}_{i \in I}$ be the affine cover. We choose recursively very good filtrations on $\bigcap_{i \in J} U_i$ with decreasing order of J , compatible with the inclusions.

We extend the construction inductively to complexes, starting with the highest term of the complex. \square

Definition 9.2.15. Let $X_{\bullet} \in C_-(\mathbb{Z}[\text{Aff}])$. A *very good filtration* of X_{\bullet} is given by a very good filtration $F_{\bullet} X_n$ for all n which is compatible with all morphisms in the support of the differentials of X_{\bullet} .

Lemma 9.2.16. *Let $X_{\bullet} \in C_b(\mathbb{Z}[\text{Var}])$ and $\tilde{U}_{X_{\bullet}}$ be an affine cover of X_{\bullet} with a very good filtration. Then the total complex of $C_{\star}(\tilde{U}_{X_{\bullet}})$ carries a very good filtration.*

Proof. Clear by construction. \square

9.2.3 Putting things together

Let R be a noetherian ring, flat over \mathbb{Z} . Let \mathcal{A} be an abelian category with a faithful forgetful functor $f : \mathcal{A} \rightarrow R\text{-Mod}$. Let $T : \text{VGood}^{\text{eff}} \rightarrow \mathcal{A}$ be a representation of the diagram of very good pairs such that $f \circ T$ is singular cohomology with coefficients in R , i.e., equal to $H^* \otimes R$.

Definition 9.2.17. Let $F_{\bullet} X$ be an affine variety X together with a very good filtration F_{\bullet} . We let $\tilde{R}(F_{\bullet} X) \in C^b(\mathcal{A})$ be

$$\cdots \rightarrow T(F_j X_{\bullet}, F_{j-1} X_{\bullet}) \rightarrow T(F_{j+1} X_{\bullet}, F_j X_{\bullet}) \rightarrow \cdots$$

Let $F_{\bullet} X_{\bullet}$ be a very good filtration of a complex $X_{\bullet} \in C_-(\mathbb{Z}[\text{Aff}])$. We let $\tilde{R}(F_{\bullet} X_{\bullet}) \in C^+(\mathcal{A})$ be the total complex of the double complex $\tilde{R}(F_{\bullet} X_n)_{n \in \mathbb{Z}}$.

Note that $\tilde{R}(F_\bullet X)$ is indeed a complex because this can be tested in singular cohomology, where it is true by Corollary 2.3.13.

Proposition 9.2.18. *Let R be a noetherian ring, flat over \mathbb{Z} , and \mathcal{A} be an R -linear abelian category with a faithful forgetful functor f to $R\text{-Mod}$. Let $T : \text{VGood}^{\text{eff}} \rightarrow \mathcal{A}$ be a representation such that $f \circ T$ is singular cohomology with R -coefficients. Then there is a natural contravariant triangulated functor*

$$R : C_b(\mathbb{Z}[\text{Var}]) \rightarrow D^b(\mathcal{A})$$

on the category of bounded homological complexes in $\mathbb{Z}[\text{Var}]$ such that for every good pair (X, Y, i) we have

$$H^j(R(\text{Cone}(Y \rightarrow X))) = \begin{cases} 0 & j \neq i, \\ T(X, Y, i) & j = i. \end{cases}$$

Moreover, the image of $R(X)$ in $D^b(R\text{-Mod})$ computes the singular cohomology of X .

Proof. The last assertion holds by Corollary 2.3.13.

We first define $R : C_b(\mathbb{Z}[\text{Var}]) \rightarrow D^b(\mathcal{A})$ on objects. Let $X_\bullet \in C_b(\mathbb{Z}[\text{Var}])$. Choose a rigidified affine cover \tilde{U}_{X_\bullet} of X_\bullet . This is possible by Lemma 9.2.11. Choose a very good filtration on the cover. This is possible by Lemma 9.2.14. It induces a very good filtration on $\text{Tot}C_\star(\tilde{U}_{X_\bullet})$. Put

$$R(X_\bullet) = \tilde{R}(\text{Tot}C_\star(\tilde{U}_{X_\bullet})).$$

Note that any other choice yields a complex isomorphic to this one in $D^+(\mathcal{A})$ because f is faithful and exact and the image of $R(X_\bullet)$ in $D^+(R\text{-Mod})$ computes singular cohomology with R -coefficients.

Let $f : X_\bullet \rightarrow Y_\bullet$ be a morphism. Choose a refinement \tilde{U}'_{X_\bullet} of \tilde{U}_{X_\bullet} which maps to \tilde{U}_{Y_\bullet} and a very good filtration on \tilde{U}'_{X_\bullet} . Choose a refinement of the filtrations on \tilde{U}_{X_\bullet} and \tilde{U}_{Y_\bullet} compatible with the filtration on \tilde{U}'_{X_\bullet} . This gives a little diagram of morphisms of complexes \tilde{R} which defines $R(f)$ in $D^+(\mathcal{A})$. \square

Remark 9.2.19. Nori suggests working with Ind-objects (or rather Pro-objects in our dual setting) in order to get functorial complexes attached to affine varieties. However, the mixing between inductive and projective systems in our construction does not make it obvious if this works out for the result we needed.

As a corollary of the construction in the proof, we also get:

Corollary 9.2.20. *Let X be a variety and \tilde{U}_X a rigidified affine cover with Čech complex $C_\star(\tilde{U}_X)$. Then*

$$R(X) \rightarrow R(C_\star(\tilde{U}_X))$$

is an isomorphism in $D^+(\mathcal{A})$.

We are mostly interested in two explicit examples of complexes.

Definition 9.2.21. Consider the situation of Proposition 9.2.18. Let $Y \subset X$ be a closed subvariety with open complement U . For $i \in \mathbb{Z}$, we put

$$R(X, Y) = R(\text{Cone}(Y \rightarrow X)), \quad R_Y(X) = R(\text{Cone}(U \rightarrow X)) \in D^b(\mathcal{A})$$

$$H(X, Y, i) = H^i(R(X, Y)), \quad H_Y(X, i) = H^i(R_Y(X)) \in \mathcal{A}.$$

$H(X, Y, i)$ is called *relative cohomology*. $H_Y(X, i)$ is called *cohomology with support*.

9.2.4 Comparing diagram categories

We are now ready to prove the first key theorems.

Theorem 9.2.22. *The diagram categories $\mathcal{C}(\text{Pairs}^{\text{eff}}, H^*)$, $\mathcal{C}(\text{Good}^{\text{eff}}, H^*)$ and $\mathcal{C}(\text{VGood}^{\text{eff}}, H^*)$ are equivalent.*

Proof. The inclusion of diagrams induces faithful functors

$$i : \mathcal{C}(\text{VGood}^{\text{eff}}, H^*) \rightarrow \mathcal{C}(\text{Good}^{\text{eff}}, H^*) \rightarrow \mathcal{C}(\text{Pairs}^{\text{eff}}, H^*).$$

We want to apply Corollary 7.1.19. Hence it suffices to represent the diagram $\text{Pairs}^{\text{eff}}$ in $\mathcal{C}(\text{VGood}^{\text{eff}}, H^*)$ such that the restriction of the representation to $\text{VGood}^{\text{eff}}$ gives back H^* (up to natural isomorphism).

We turn to the construction of the representation of $\text{Pairs}^{\text{eff}}$ in the category $\mathcal{C}(\text{VGood}^{\text{eff}}, H^*)$. We apply Proposition 9.2.18 to

$$H^* : \text{VGood}^{\text{eff}} \rightarrow \mathcal{C}(\text{VGood}^{\text{eff}}, H^*)$$

and get a functor

$$R : C_b(\mathbb{Z}[\text{Var}]) \rightarrow D^b(\mathcal{C}(\text{VGood}^{\text{eff}}, H^*)).$$

Consider an effective pair (X, Y, i) in $\text{Pairs}^{\text{eff}}$. We represent it by

$$H(X, Y, i) = H^i(R(X, Y)) \in \mathcal{C}(\text{VGood}^{\text{eff}}, H^*),$$

where

$$R(X, Y) = R(\text{Cone}(Y \rightarrow X)).$$

The construction is functorial for morphisms of pairs. This allows us to represent edges of type f^* .

Finally, we need to consider edges corresponding to coboundary maps for triples $X \supset Y \supset Z$. In this case, it follows from the construction of R that

there is a natural exact triangle

$$R(X, Y) \rightarrow R(X, Z) \rightarrow R(Y, Z).$$

We use the connecting morphism in cohomology to represent the edge $(Y, Z, i) \rightarrow (X, Y, i + 1)$. \square

For further use, we record a number of corollaries.

Corollary 9.2.23. *Every object of $\mathcal{MM}_{\text{Nori}}^{\text{eff}}$ is a subquotient of a direct sum of objects of the form $H_{\text{Nori}}^i(X, Y)$ for a good pair (X, Y, i) where $X = W \setminus W_\infty$ and $Y = W_0 \setminus (W_0 \cap W_\infty)$ with W smooth projective, $W_\infty \cup W_0$ a divisor with normal crossings.*

Proof. By Proposition 7.1.16, every object in the diagram category of $\text{VGood}^{\text{eff}}$ (and hence $\mathcal{MM}_{\text{Nori}}$) is a subquotient of a direct sum of some $H_{\text{Nori}}^i(X, Y)$ with (X, Y, i) very good. In particular, $X \setminus Y$ can be assumed smooth.

We follow Nori. By resolution of singularities, there is a smooth projective variety W and a normal crossing divisor $W_0 \cup W_\infty \subset W$ together with a proper, surjective morphism $\pi : W \setminus W_\infty \rightarrow X$ such that one has $\pi^{-1}(Y) = W_0 \setminus W_\infty$ and $\pi : W \setminus \pi^{-1}(Y) \rightarrow X \setminus Y$ is an isomorphism. This implies that

$$H_{\text{Nori}}^*(W \setminus W_\infty, W_0 \setminus (W_0 \cap W_\infty)) \rightarrow H_{\text{Nori}}^*(X, Y)$$

is also an isomorphism by proper base change, i.e., excision. \square

Remark 9.2.24. Note that the pair $(W \setminus W_\infty, W_0 \setminus (W_0 \cap W_\infty))$ is good, but not very good in general. Replacing Y by a larger closed subset Z , one may, however, assume that $W_0 \setminus (W_0 \cap W_\infty)$ is affine. Therefore, by Lemma 9.3.9, the dual of each generator can be assumed to be very good.

Corollary 9.2.25. *Every object of $\mathcal{MM}_{\text{Nori}}^{\text{eff}}$ is a subquotient of a direct sum of objects of the form $H_{\text{Nori}}^i(X, Y)$ with X smooth affine and Y a divisor with normal crossings.*

Proof. As in the proof of the last corollary, every object of $\mathcal{MM}_{\text{Nori}}$ is a subquotient of a direct sum of some $H_{\text{Nori}}^i(X, Y)$ with (X, Y, i) very good. In particular, $X \setminus Y$ can be assumed smooth. By resolution of singularities, there is a proper surjective map $\pi : X' \rightarrow X$ which is an isomorphism outside Y with X' smooth quasi-projective and $Y' = \pi^{-1}Y$ a divisor with normal crossings. By excision, we have an isomorphism

$$H_{\text{Nori}}^i(X', Y') \cong H_{\text{Nori}}^i(X, Y).$$

By Jouanolou's trick, see [Jou73, Lemme 1.5] there is an \mathbb{A}^n -fibre bundle $X'' \rightarrow X'$ with X'' affine. As X' and \mathbb{A}^n are smooth, so is X'' . The preimage of Y' in X'' is again a divisor with normal crossings. By homotopy invariance, we have

$$H_{\text{Nori}}^i(X'', Y'') \cong H_{\text{Nori}}^i(X', Y').$$

□

Definition 9.2.26. Let $Z \subset X$ be a closed immersion with open complement U . We call

$$H_Z^i(X) = H^i(\mathrm{RCone}(U \rightarrow X)) \in \mathcal{MM}_{\mathrm{Nori}}$$

the *motive of X with support in Z* .

Corollary 9.2.27. Let $Z \subset X$ be a closed immersion with open complement U . Then the motive $H_Z^i(X)$ in $\mathcal{MM}_{\mathrm{Nori}}$ represents cohomology with support. There is a natural long exact sequence

$$\cdots \rightarrow H_Z^i(X) \rightarrow H_{\mathrm{Nori}}^i(X) \rightarrow H_{\mathrm{Nori}}^i(U) \rightarrow H_Z^{i+1}(X) \rightarrow \cdots$$

Proof. Both assertions follow from the distinguished triangle

$$R(\mathrm{Cone}(U \rightarrow X)) \rightarrow R(X) \rightarrow R(U).$$

□

9.3 Tensor structure

We now introduce the tensor structure using the formal set-up developed in Section 8.1. Recall that $\mathrm{Pairs}^{\mathrm{eff}}$, $\mathrm{Good}^{\mathrm{eff}}$ and $\mathrm{VGood}^{\mathrm{eff}}$ are graded diagrams with $|(X, Y, i)| = i \pmod{2}$.

Proposition 9.3.1. *The graded diagrams Good and $\mathrm{VGood}^{\mathrm{eff}}$ carry a weak commutative product structure in the sense of Remark 8.1.6 defined as follows: for all vertices $(X, Y, i), (X', Y', i')$*

$$(X, Y, i) \times (X', Y', i') = (X \times X', X \times Y' \cup Y \times X', i + i'),$$

with the obvious definition on edges. Let also

$$\begin{aligned} \alpha &: (X, Y, i) \times (X', Y', i') \rightarrow (X', Y', i') \times (X, Y, i) \\ \beta &: (X, Y, i) \times ((X', Y', i') \times (X'', Y'', i'')) \rightarrow ((X, Y, i) \times (X', Y', i')) \times (X'', Y'', i'') \\ \beta' &: ((X, Y, i) \times (X', Y', i')) \times (X'', Y'', i'') \rightarrow (X, Y, i) \times ((X', Y', i') \times (X'', Y'', i'')) \end{aligned}$$

be the edges given by the natural isomorphisms of varieties.

There is a unit given by $(\mathrm{Spec}(k), \emptyset, 0)$ and

$$u : (X, Y, i) \rightarrow (\mathrm{Spec}(k), \emptyset, 0) \times (X, Y, i) = (\mathrm{Spec}(k) \times X, \mathrm{Spec}(k) \times Y, i)$$

given by the natural isomorphism of varieties.

Moreover, H^* is a weak graded multiplicative representation in the sense of Definition 8.1.3 and Remark 8.1.6 with

$$\tau : H^{i+i'}(X \times X', X \times Y' \cup X' \times Y; \mathbb{Z}) \rightarrow H^i(X, Y, \mathbb{Z}) \otimes H^{i'}(X', Y'; \mathbb{Z})$$

the Künneth isomorphism, cf. Theorem 2.4.1.

Proof. If (X, Y, i) and (X', Y', i') are good pairs, then so is $(X \times X', X \times Y' \cup Y \times X', i + i')$ by the Künneth formula. If they are even very good, then so is their product. Hence \times is well-defined on vertices. Recall that edges of $\text{Good}^{\text{eff}} \times \text{Good}^{\text{eff}}$ are of the form $\gamma \times \text{id}$ or $\text{id} \times \gamma$ for an edge γ of Good^{eff} . The definition of \times on these edges is the natural one. We explain the case $\delta \times \text{id}$ in detail. Let $X \supset Y \supset Z$ and $A \supset B$. We compose the functoriality edge for

$$(Y \times A, Z \times A \cup Y \times B) \rightarrow (Y \times A \cup X \times B, Z \times A \cup Y \times B)$$

with the boundary edge for

$$X \times A \supset Y \times A \cup X \times B \supset Z \times A \cup Y \times B$$

and obtain

$$\begin{aligned} \delta \times \text{id} : (Y, Z, n) \times (A, B, m) &= (Y \times A, Z \times A \cup Y \times B, n + m) \\ &\rightarrow (X \times A, Y \times A \cup X \times B, n + m + 1) = (X, Y, n + 1) \times (A, B, m) \end{aligned}$$

as a morphism in the path category $\mathcal{P}(\text{Good}^{\text{eff}})$.

We need to check that H^* satisfies the conditions of Definition 8.1.3. This is tedious, but straightforward from the properties of the Künneth formula, see in particular Proposition 2.4.3 for compatibility with edges of type ∂ changing the degree.

Associativity and graded commutativity are stated in Proposition 2.4.2. \square

Definition 9.3.2. Let Good and VGood be the localisations (see Definition 8.2.1) of Good^{eff} and $\text{VGood}^{\text{eff}}$, respectively, with respect to the vertex $\mathbf{1}(-1) = (\mathbb{G}_m, \{1\}, 1)$.

Proposition 9.3.3. *Good and VGood are graded diagrams with a weak commutative product structure in the sense of Remark 8.1.6. Moreover, H^* is a graded multiplicative representation of Good and VGood.*

Proof. This follows formally from the effective case and Lemma 8.2.4. The assumption 8.2.3 that $H^*(\mathbf{1}(-1)) \cong \mathbb{Z}$ is satisfied by Proposition 9.1.2. \square

Theorem 9.3.4. 1. *This definition of $\mathcal{MM}_{\text{Nori}}$ is equivalent to Nori's original definition.*

2. $\mathcal{MM}_{\text{Nori}}^{\text{eff}} \subset \mathcal{MM}_{\text{Nori}}$ are commutative tensor categories with a faithful fibre functor H^* .

3. $\mathcal{MM}_{\text{Nori}}$ is equivalent to the two diagram categories $\mathcal{C}(\text{Good}, H^*)$ and $\mathcal{C}(\text{VGood}, H^*)$.

Proof. We already know by Theorem 9.2.22 that

$$\mathcal{C}(\text{VGood}^{\text{eff}}, H^*) \rightarrow \mathcal{C}(\text{Good}^{\text{eff}}, H^*) \rightarrow \mathcal{C}(\text{Pairs}^{\text{eff}}, H^*) = \mathcal{MM}_{\text{Nori}}^{\text{eff}}$$

are equivalent. Moreover, this agrees with Nori's definition using either Good^{eff} or $\text{Pairs}^{\text{eff}}$.

By Proposition 9.3.1, the diagrams $\text{VGood}^{\text{eff}}$ and Good^{eff} carry a multiplicative structure. Hence, by Proposition 8.1.5, the category $\mathcal{MM}_{\text{Nori}}^{\text{eff}}$ carries a tensor structure.

By Proposition 8.2.5, the diagram categories of the localised diagrams Good and VGood also have tensor structures and can be equivalently defined as the localisation with respect to the Lefschetz object $\mathbf{1}(-1)$.

In [Lev05], the category of Nori motives is defined as the category of comodules of finite type over \mathbb{Z} for the localisation of the ring A^{eff} with respect to the element $\chi \in A(\mathbf{1}(-1))$ considered in Proposition 8.2.5. By this same Proposition, the category of A_{χ}^{eff} -comodules agrees with $\mathcal{MM}_{\text{Nori}}^{\text{eff}}$. \square

Remark 9.3.5. We do not know if the inclusion $\mathcal{MM}_{\text{Nori}}^{\text{eff}} \rightarrow \mathcal{MM}_{\text{Nori}}$ is also full. On the level of categories this is equivalent to the fullness of the functor ${}_{-} \otimes \mathbf{1}(-1)$. On the level of algebras, it is equivalent to the element $\chi \in A^{\text{eff}}$ in the proof of Theorem 9.3.4 not being a divisor of zero. On the level of schemes, it is equivalent to the group $\text{Spec}(A)$ attached to $\mathcal{MM}_{\text{Nori}}$ being dense in the monoid $\text{Spec}(A^{\text{eff}})$ attached to $\mathcal{MM}_{\text{Nori}}^{\text{eff}}$.

Our next aim is to establish rigidity using the criterion of Section 8.3. Hence, we need to check that Poincaré duality is motivic, at least in a weak sense.

Remark 9.3.6. An alternative argument using Harrer's realisation functor from geometric motives (see Theorem 10.1.4) is explained in Corollary 10.1.6.

Definition 9.3.7. Let $\mathbf{1}(-1) = H_{\text{Nori}}^1(\mathbb{G}_m)$ and $\mathbf{1}(-n) = \mathbf{1}(-1)^{\otimes n}$.

Lemma 9.3.8. 1. $H_{\text{Nori}}^{2n}(\mathbb{P}^N) = \mathbf{1}(-n)$ for $N \geq n \geq 0$.

2. Let Z be a projective variety of dimension n . Then $H_{\text{Nori}}^{2n}(Z) \cong \mathbf{1}(-n)$.

3. Let X be a smooth variety and $Z \subset X$ a smooth, irreducible, closed subvariety of pure codimension n . Then the motive with support of Definition 9.2.26 satisfies

$$H_Z^{2n}(X) \cong \mathbf{1}(-n).$$

Proof. Recall that singular cohomology is faithful on Nori motives. Hence, in all the above statements we have to construct a morphism of motives and check that it is an isomorphism in singular cohomology.

1. For $n \leq N$ let $\mathbb{P}^n \subset \mathbb{P}^N$ be the natural linear immersion. It induces an isomorphism on singular cohomology up to degree $2n$, and hence on motives up to degree $2n$. Hence it suffices to check the top cohomology of \mathbb{P}^N .

We start with \mathbb{P}^1 . Consider the standard cover of \mathbb{P}^1 by $U_1 = \mathbb{A}^1$ and $U_2 = \mathbb{P}^1 \setminus \{0\}$. We have $U_1 \cap U_2 = \mathbb{G}_m$. By Corollary 9.2.20,

$$R(\mathbb{P}^1) \rightarrow \text{Cone}\left(R(U_1) \oplus R(U_2) \rightarrow R(\mathbb{G}_m)\right)[-1]$$

is an isomorphism in $D^b(\mathcal{M}\mathcal{M}_{\text{Nori}})$. This induces the isomorphism

$$H_{\text{Nori}}^2(\mathbb{P}^1) \rightarrow H_{\text{Nori}}^1(\mathbb{G}_m) \cong \mathbf{1}(-1).$$

Similarly, the Čech complex (see Definition 9.2.12) for the standard affine cover of \mathbb{P}^N relates $H_{\text{Nori}}^{2N}(\mathbb{P}^N)$ to $H_{\text{Nori}}^N(\mathbb{G}_m^N) \cong H_{\text{Nori}}^1(\mathbb{G}_m)^{\otimes n} \cong \mathbf{1}(-n)$.

2. Let $Z \subset \mathbb{P}^N$ be a closed immersion with N large enough. Then $H_{\text{Nori}}^{2n}(Z) \rightarrow H_{\text{Nori}}^{2n}(\mathbb{P}^N)$ is an isomorphism in $\mathcal{M}\mathcal{M}_{\text{Nori}}$ because it is in singular cohomology.

3. Assertion 3. holds in singular cohomology by the Gysin isomorphism, see Proposition 2.1.9

$$H^0(Z) \xrightarrow{\cong} H_Z^{2n}(X).$$

We now construct the map motivically. For the embedding $Z \subset X$ one has the deformation to the *normal cone* [Ful84, Sec. 5.1], i.e., a smooth scheme $D(X, Z)$ together with a morphism to \mathbb{A}^1 such that the fibre over 0 is given by the *normal bundle* $N_Z X$ of Z in X , and the other fibres by X . The product $Z \times \mathbb{A}^1$ can be embedded into $D(X, Z)$ as a closed subvariety of codimension n , inducing the embeddings of $Z \subset X$ as well as the embedding of the zero section $Z \subset N_Z X$ over 0.

In all, we have for $t \neq 0$:

$$\begin{array}{ccccc} Z & \longrightarrow & Z \times \mathbb{A}^1 & \longleftarrow & Z \\ \downarrow 0 & & \downarrow & & \downarrow \\ N_Z(X) & \longrightarrow & D(X, Z) & \longleftarrow & X \\ \downarrow & & \downarrow & & \downarrow \\ \{0\} & \longrightarrow & \mathbb{A}^1 & \longleftarrow & \{1\} \end{array}$$

The natural maps

$$H_Z^{2n}(X) \leftarrow H_{Z \times \mathbb{A}^1}^{2n}(D(X, Z)) \rightarrow H_Z^{2n}(N_Z X)$$

are isomorphisms in singular cohomology by the three Gysin isomorphisms and homotopy invariance. Hence they are also isomorphisms of motives. Thus, we have reduced the problem to the embedding of the zero section $Z \hookrightarrow N_Z X$. However, the normal bundle $\pi : N_Z X \rightarrow Z$ trivialises on some dense open subset $U \subset Z$. This induces an isomorphism

$$H_Z^{2n}(N_Z X) \rightarrow H_U^{2n}(\pi^{-1}(U)),$$

and we may assume that the normal bundle $N_Z X$ is trivial. In this case, we have

$$N_Z(X) \cong N_{Z \times \{0\}}(Z \times \mathbb{A}^n) \cong Z \times N_{\{0\}}(\mathbb{A}^n).$$

By the Gysin isomorphism, $H_{\{0\}}^*(N_{\{0\}}(\mathbb{A}^n))$ is concentrated in degree $2n$. By the Künneth formula with supports,

$$H_{\{0\}}^{2n}(\mathbb{A}^n) \cong H_{\{0\}}^2(\mathbb{A}^1)^{\otimes n} \cong \mathbf{1}(-n).$$

The formula for $H_{\text{Nori}}^{2n}(Z \times N_{\{0\}}(\mathbb{A}^n))$ follows from the Künneth formula. \square

The following lemma (more precisely, its dual) is formulated implicitly in [Nor00] in order to establish rigidity of $\mathcal{MM}_{\text{Nori}}$.

Lemma 9.3.9. *Let W be a smooth projective variety of dimension i , and $W_0, W_\infty \subset W$ divisors such that $W_0 \cup W_\infty$ is a normal crossing divisor. Let*

$$\begin{aligned} X &= W \setminus W_\infty \\ Y &= W_0 \setminus (W_0 \cap W_\infty) \\ X' &= W \setminus W_0 \\ Y' &= W_\infty \setminus (W_0 \cap W_\infty) \end{aligned}$$

We assume that (X, Y) is a very good pair.

Then there is a morphism in $\mathcal{MM}_{\text{Nori}}$

$$q : \mathbf{1} \rightarrow H_{\text{Nori}}^i(X, Y) \otimes H_{\text{Nori}}^i(X', Y')(i)$$

such that the dual of $H^(q)$ is a perfect pairing.*

Proof. We follow Nori's construction. The two pairs (X, Y) and (X', Y') are Poincaré dual to each other in singular cohomology, see Proposition 2.4.5 for the proof. This implies that they are both good pairs. Hence

$$H_{\text{Nori}}^i(X, Y) \otimes H_{\text{Nori}}^i(X', Y') \rightarrow H_{\text{Nori}}^{2i}(X \times X', X \times Y' \cup Y \times X')$$

is an isomorphism. Let $\Delta = \Delta(W \setminus (W_0 \cup W_\infty))$ via the diagonal map Δ . Note that

$$X \times Y' \cup X' \times Y \subset (X \times X') \setminus \Delta.$$

Hence, by functoriality and the definition of cohomology with support, there is a map

$$H_{\text{Nori}}^{2i}(X \times X', X \times Y' \cup Y \times X') \leftarrow H_{\Delta}^{2i}(X \times X').$$

Again, by functoriality, there is a map

$$H_{\Delta}^{2i}(X \times X') \leftarrow H_{\Delta}^{2i}(W \times W)$$

with $\bar{\Delta} = \Delta(W)$. By Lemma 9.3.8, this motive is isomorphic to $\mathbf{1}(-i)$. The map q is defined by twisting the composition by (i) . The dual of this map realises Poincaré duality, hence it is a perfect pairing. \square

Theorem 9.3.10 (Nori). *Let $k \subset \mathbb{C}$ be a field. Then $\mathcal{MM}_{\text{Nori}}(k)$ is rigid, hence a neutral Tannakian category. It is equivalent to the category of linear algebraic representations (see Definition 8.1.13) of the affine faithfully flat group scheme over \mathbb{Z}*

$$G_{\text{mot}}(k, \mathbb{Q}) := \text{Spec}(A(\text{Good}, H^*)).$$

Proof. We apply the criterion of Proposition 8.3.4. Let S be the set of objects $\mathcal{MM}_{\text{Nori}}$ of the form $H_{\text{Nori}}^i(X, Y)(j)$ of the particular form occurring in Lemma 9.3.9. By this lemma, they admit a perfect pairing. It remains to check that it generates $\mathcal{MM}_{\text{Nori}}$ in the sense of Definition 8.1.9. By Lemma 8.1.11 the category is generated by the set $\{\tilde{T}v | v \in \text{VGood}\}$. By Corollary 9.2.23 and its proof, every such object is isomorphic to one of the special shape. Hence by Corollary 8.1.17, the category is equivalent to the category of linear algebraic representations of the monoid $G_{\text{mot}}(k, \mathbb{Z})$. By Proposition 8.3.4, the monoid is a group. \square

9.3.1 Collection of proofs

We go through the list of theorems of Section 9.1 and give the missing proofs.

Proof of Theorem 9.1.5. By Theorem 9.3.4, the categories $\mathcal{MM}_{\text{Nori}}^{\text{eff}}$ and $\mathcal{MM}_{\text{Nori}}$ are tensor categories. By construction, H^* is a tensor functor. The category $\mathcal{MM}_{\text{Nori}}$ is rigid by Theorem 9.3.10. By loc. cit., we have a description of its Tannaka dual. \square

Proof of Theorem 9.1.9. We apply Proposition 9.2.18 with $\mathcal{A} = \mathcal{MM}_{\text{Nori}}^{\text{eff}}$ and $T = H^*$, $R = \mathbb{Z}$. \square

Proof of Theorem 9.1.10. In the first step, we use the natural functor

$$\mathcal{MM}_{\text{Nori}}^{\text{eff}} \rightarrow \mathcal{C}(\text{Good}^{\text{eff}}, H_R^*)$$

which exists by Lemma 7.2.8 because R is flat over \mathbb{Z} . We then apply the universal property of the diagram category (see Corollary 7.1.15) to the diagram Good^{eff} , $T = H_R^*$ and $F = H^*$. This gives the universal property for $\mathcal{MM}_{\text{Nori}}^{\text{eff}}$.

Recall that $H^*(\mathbf{1}(-1)) \cong R$ by comparison with singular cohomology. Hence everything extends to $\mathcal{MM}_{\text{Nori}}$ by localising the categories.

If \mathcal{A} is a tensor category and H^* a graded multiplicative representation, then all functors are tensor functors by construction. \square

9.4 Artin motives

We go through the baby case of 0-motives, i.e., those generated by 0-dimensional varieties. We restrict to rational coefficients.

Definition 9.4.1. Let $\text{Pairs}^0 \subset \text{Pairs}^{\text{eff}}$ be the subdiagram of vertices (X, Y, n) with $\dim X = 0$. Let $\mathcal{MM}_{\text{Nori}, \mathbb{Q}}^0$ be its diagram category with respect to the representation of $\text{Pairs}^{\text{eff}}$ given by singular cohomology with rational coefficients. Let $\text{Var}^0 \subset \text{Pairs}^0$ be the diagram defined by the opposite category of 0-dimensional k -varieties, or equivalently, the category of finite separable k -algebras.

If $\dim X = 0$, then $\dim Y = 0$ and X decomposes into a disjoint union of Y and $X \setminus Y$. Hence $H^*(X, Y; \mathbb{Q}) = H^*(X \setminus Y, \mathbb{Q})$ and it suffices to consider only vertices with $Y = \emptyset$. Moreover, all cohomology is concentrated in degree 0, and the pairs $(X, Y, 0)$ are all good and even very good. In particular, the multiplicative structure on Good^{eff} restricts to the obvious multiplicative structure on Pairs^0 and Var^0 .

We are always going to work with the multiplicative diagram Var^0 in the sequel.

Definition 9.4.2. Let $G_{\text{mot}}^0(k)$ be the Tannaka dual of $\mathcal{MM}_{\text{Nori}, \mathbb{Q}}^0$.

The notation is a bit awkward because G^0 often denotes the connected component of unity of a group scheme G . Our $G_{\text{mot}}^0(k)$ is very much *not* connected.

Our aim is to show that $G_{\text{mot}}^0(k) = \text{Gal}(\bar{k}/k)$. By construction of the coalgebra in Corollary 7.5.7, we have

$$A(\text{Var}^0, H^0) = \text{colim}_F \text{End}(H^0|_F)^\vee,$$

where F runs through a system of finite subdiagrams whose union is Var^0 .

We start with the case when F has a single vertex $\text{Spec}(K)$, with K/k a finite field extension, $Y = \text{Spec}(K)$. The endomorphisms of the vertex are given by the elements of the Galois group $G = \text{Gal}(K/k)$. We spell out $H^0(Y, \mathbb{Q})$. We have

$$Y(\mathbb{C}) = \text{Mor}_k(\text{Spec}(\mathbb{C}), \text{Spec}(K)) = \text{Hom}_{k\text{-alg}}(K, \mathbb{C}),$$

the set of field embeddings of K into \mathbb{C} , viewed as a finite set with the discrete topology. Singular cohomology attaches a copy of \mathbb{Q} to each point, hence

$$H^0(Y(\mathbb{C}), \mathbb{Q}) = \text{Maps}(Y(\mathbb{C}), \mathbb{Q}) = \text{Maps}(\text{Hom}_{k\text{-alg}}(K, \mathbb{C}), \mathbb{Q}).$$

As always, this is contravariant in Y , hence covariant in fields. The left operation of the Galois group G on K induces a left operation on $H^0(Y(\mathbb{C}), \mathbb{Q})$.

Let K/k be a Galois extension of degree d . We compute the ring of endomorphisms of H^0 on the single vertex $\text{Spec}(K)$ (see Definition 7.1.8)

$$E = \text{End}(H^0|_{\text{Spec}(K)}).$$

By definition, its elements are the endomorphisms of $H^0(\text{Spec}(K), \mathbb{Q})$ commuting with the operation of the Galois group. The set $Y(\mathbb{C})$ has a simply transitive action of G . Hence, $\text{Maps}(Y(\mathbb{C}), \mathbb{Q})$ is a free $\mathbb{Q}[G]^{op}$ -module of rank 1. Its centraliser E is then isomorphic to $\mathbb{Q}[G]$. This statement already makes the algebra structure on E explicit.

The diagram algebra does not change when we consider the diagram $\text{Var}^0(K)$ containing all vertices of the form A with $A = \bigoplus_{i=1}^n K_i$, $K_i \subset K$.

There are two essential cases: If $K' \subset K$ is a subfield, we have a surjective map $Y(\mathbb{C}) \rightarrow Y'(\mathbb{C})$. The compatibility condition with respect to this map implies that the value of the diagram endomorphism on K' is already determined by its value on K . If $A = K \oplus K$, then compatibility with the inclusion of the first and the second factor implies that the value of the diagram endomorphism on A is already determined by its value on K .

In more abstract language: The category $\text{Var}^0(K)$ is equivalent to the category of finite G -sets. The algebra E is the group ring of the Galois group of this category under the representation $S \mapsto \text{Maps}(S, \mathbb{Q})$.

Note that $K \otimes_k K = \bigoplus_{\sigma} K$, with σ running through the Galois group, is in $\text{Var}^0(K)$. The category has fibre products. In the language of Definition 8.1.3, the diagram $\text{Var}^0(K)$ has a commutative product structure (with trivial grading). By Proposition 8.1.5 and its proof, the diagram category is a tensor category, or equivalently, E carries a comultiplication.

We go through the construction in the proof of loc. cit. We start with an element of E and view it as an endomorphism of $H^0(Y \times Y(\mathbb{C}), \mathbb{Q}) \cong H^0(Y(\mathbb{C}), \mathbb{Q}) \otimes H^0(Y(\mathbb{C}), \mathbb{Q})$, hence as a tensor product of endomorphisms of $H^0(Y(\mathbb{C}), \mathbb{Q})$. The operation of $E = \mathbb{Q}[G]$ on $\text{Maps}(Y(\mathbb{C}) \times Y(\mathbb{C}), \mathbb{Q})$ is determined by the condition that it has to be compatible with the diagonal map $Y(\mathbb{C}) \rightarrow Y(\mathbb{C}) \times Y(\mathbb{C})$. This amounts to the diagonal embedding $\mathbb{Q}[G] \rightarrow \mathbb{Q}[G] \otimes \mathbb{Q}[G]$.

Thus we have shown that $E \cong \mathbb{Q}[G]$ as a bialgebra. This means that

$$G_{\text{mot}}(Y) := \text{Spec}(A(\langle \text{Spec}(K) \rangle, H^*)) = \text{Spec}(E^{\vee}) \cong G$$

as a constant monoid (even group) scheme over \mathbb{Q} .

Passing to the limit over all K we get

$$G_{\text{mot}}^0(k) \cong \text{Gal}(\bar{k}/k)$$

as proalgebraic group schemes over \mathbb{Q} of dimension 0. As a byproduct, we see that the monoid attached to $\mathcal{MM}_{\text{Nori}, \mathbb{Q}}^0$ is a group, hence the category is rigid.

Recall that it is in general not clear whether the subcategory of effective Nori motives is full in the category of all Nori motives. The situation is better in the case of 0-motives.

Proposition 9.4.3. $\mathcal{MM}_{\text{Nori},\mathbb{Q}}^0$ is a full subcategory of $\mathcal{MM}_{\text{Nori},\mathbb{Q}}$.

Proof. The natural functor $\mathcal{MM}_{\text{Nori},\mathbb{Q}}^0 \rightarrow \mathcal{MM}_{\text{Nori},\mathbb{Q}}^{\text{eff}} \rightarrow \mathcal{MM}_{\text{Nori},\mathbb{Q}}$ is faithful and exact. It remains to check fullness on generating objects. Let K/k and L/k be finite field extensions. Let

$$f : H_{\text{Nori}}^0(\text{Spec}(K)) \rightarrow H_{\text{Nori}}^0(\text{Spec}(L))$$

be a morphism in $\mathcal{MM}_{\text{Nori},\mathbb{Q}}$. It is $\text{Gal}(\bar{k}/k)$ -equivariant as a map of the underlying vector spaces by functoriality. Hence it is a morphism in the category $\mathcal{MM}_{\text{Nori}}^0$ of $\text{Gal}(\bar{k}/k)$ -modules. \square

9.5 Change of fields

We investigate how the categories of motives for different base fields are related.

Lemma 9.5.1. Let K/k be field extension, $K \subset \mathbb{C}$. Then the base change functor $X \mapsto X_K$ for varieties induces an exact tensor functor

$$\text{res}_{K/k} : \mathcal{MM}_{\text{Nori}}(k) \rightarrow \mathcal{MM}_{\text{Nori}}(K).$$

We call this the *restriction functor* because this is what it is from the point of view of representations of motivic Galois groups.

Proof. We write $\text{Pairs}^{\text{eff}}(k)$ for the diagram of effective pairs over k and analogously for the other diagrams. Let $(X, Y, i) \in \text{Pairs}^{\text{eff}}(k)$. Then $(X_K, Y_K, i) \in \text{Pairs}^{\text{eff}}(K)$. Note that $X \times_k \mathbb{C} = X_K \times_K \mathbb{C}$ and hence

$$H^i(X, Y; \mathbb{Z}) = H^i(X_K, Y_K; \mathbb{Z}).$$

We obtain a representation of $\text{Pairs}^{\text{eff}}(k)$ in $\mathcal{MM}_{\text{Nori}}(K)$ compatible with the representation in $\mathbb{Z}\text{-Mod}$ defined by singular cohomology by

$$(X, Y, i) \mapsto H_{\text{Nori}}^i(X_K, Y_K).$$

By the universal property of Nori motives, this induces the required exact functor

$$\mathcal{MM}_{\text{Nori}}^{\text{eff}}(k) \rightarrow \mathcal{MM}_{\text{Nori}}^{\text{eff}}(K).$$

It respects the subdiagrams of very good effective pairs and is compatible with multiplicative structures. Hence it is also a tensor functor. It maps $\mathbf{1}(-1)$ to $\mathbf{1}(-1)$, hence the functor extends to the localised categories. \square

Proposition 9.5.2. Let K/k be an algebraic field extension, $K \subset k$. Then the base change functor induces an equivalence

$$\mathcal{M}\mathcal{M}_{\text{Nori}}(K) \cong 2\text{-colim}_{k'/k} \mathcal{M}\mathcal{M}_{\text{Nori}}(k')$$

where the limit is over the system of intermediate fields $K \supset k' \supset k$ with k'/k finite.

Proof. From base change, we have a canonical functor

$$2\text{-colim}_{\substack{k'/k \\ \text{finite}}} \mathcal{M}\mathcal{M}_{\text{Nori}}(k') \rightarrow \mathcal{M}\mathcal{M}_{\text{Nori}}(K).$$

It is exact and faithful because all categories have forgetful functors to $\mathbb{Z}\text{-Mod}$. We construct a converse functor by representing $\text{Pairs}^{\text{eff}}(K)$ in the left-hand side.

To do this, we let $(X, Y, i) \in \text{Pairs}^{\text{eff}}(K)$. It is defined over some finite extension k'/k , i.e., there is a $(X_0, Y_0, i) \in \text{Pairs}^{\text{eff}}(k')$ such that $(X_0, Y_0, i) \times'_k K = (X, Y, i)$. We assign to (X, Y, i) the image of $H_{\text{Nori}}^i(X_0, Y_0)$ in the category $2\text{-colim}_{k'/k} \mathcal{M}\mathcal{M}_{\text{Nori}}(k')$. Any two choices of models are isomorphic over a field extension, hence the assignment is well-defined.

In the same way, all edges of $\text{Pairs}^{\text{eff}}(K)$ have models over some finite subextension k'/k . From the universal property of the diagram category, we obtain a functor

$$\mathcal{M}\mathcal{M}_{\text{Nori}}^{\text{eff}}(K) \rightarrow 2\text{-colim}_{k'/k} \mathcal{M}\mathcal{M}_{\text{Nori}}^{\text{eff}}(k').$$

They are obviously inverse to each other. Everything is compatible with tensor products, hence the statement passes to the localisation. \square

For finite extensions, there is also a functor in the converse direction.

Proposition 9.5.3. *Let K/k be a finite field extension, $K \subset \mathbb{C}$. Then the restriction functor which views a K -variety as a k -variety induces an exact functor*

$$\text{cores}_{K/k} : \mathcal{M}\mathcal{M}_{\text{Nori}}(K) \rightarrow \mathcal{M}\mathcal{M}_{\text{Nori}}(k).$$

The composition with base change

$$\text{cores}_{K/k} \circ \text{res}_{K/k} : \mathcal{M}\mathcal{M}_{\text{Nori}}(k) \rightarrow \mathcal{M}\mathcal{M}_{\text{Nori}}(k)$$

is given by $-\otimes H_{\text{Nori}}^0(\text{Spec}(K))$. The converse composition

$$\text{res}_{K/k} \circ \text{cores}_{K/k} : \mathcal{M}\mathcal{M}_{\text{Nori}}(K) \rightarrow \mathcal{M}\mathcal{M}_{\text{Nori}}(K)$$

is given by $-\otimes H_{\text{Nori}}^0(\text{Spec}(K \otimes_k K))$. If K/k is Galois, then this functor is equal to $-\otimes \mathbf{1}^{[K:k]} = _{{}^{[K:k]}}$.

We call this the *corestriction functor* because this is what it seems to be from the point of view of representations of the motivic Galois group. Note the corestriction functor is *not* compatible with the tensor product.

Proof. Let $(X, Y, i) \in \text{Pairs}^{\text{eff}}(K)$. Via the structural map $X \rightarrow \text{Spec}(K) \rightarrow \text{Spec}(k)$ we may also view it as a vertex of $\text{Pairs}^{\text{eff}}(k)$. We have

$$X \times_k \mathbb{C} = X \times_K (\text{Spec}(K) \times_k \text{Spec}(K)) \times_K \mathbb{C}$$

and hence

$$H^i(X \times_k \mathbb{C}, Y \times_k \mathbb{C}; \mathbb{Z}) = H^i(X \times_K \mathbb{C}, Y \times_K \mathbb{C}; \mathbb{Z}) \otimes H^0(\text{Spec}(K) \times_k \mathbb{C}; \mathbb{Z}).$$

This defines a representation of $\text{Pairs}^{\text{eff}}$ in $\mathcal{MM}_{\text{Nori}}^{\text{eff}}(k)$ compatible with the representation $H^* \otimes \mathbb{Z}^d$ with $d = [K : k]$. By the universal property, we get a functor

$$\mathcal{C}(\text{Pairs}^{\text{eff}}(K), H^* \otimes \mathbb{Z}^d) \rightarrow \mathcal{MM}_{\text{Nori}}^{\text{eff}}(k).$$

By Morita equivalence, the category on the left is equivalent to $\mathcal{MM}_{\text{Nori}}^{\text{eff}}(k)$. In more detail: for every finite subdiagram $F \subset \text{Pairs}^{\text{eff}}$, we have

$$\text{End}(H^* \otimes \mathbb{Z}^d|_F) = M_d(\text{End}(H^*|_F)),$$

the matrix algebra over the endomorphism ring. By Example 7.3.23, this algebra has the same category of modules as $\text{End}(H^*|_F)$. Passing to the limit, this gives the claim on motives. The functor $\text{cores}_{K/k}$ is not a tensor functor, but nevertheless commutes with $_- \otimes \mathbf{1}(-1)$. Hence it passes to the localisation.

We now consider $\text{cores}_{K/k} \circ \text{res}_{K/k}$. On vertices of $\text{Pairs}^{\text{eff}}(k)$ it is induced by

$$\begin{aligned} (X, Y, i) &\mapsto (X \times_k \text{Spec}(K), Y \times_k \text{Spec}(K), i) \\ &\mapsto H_{\text{Nori}}^i(X, Y) \otimes H_{\text{Nori}}^0(\text{Spec}(K)). \end{aligned}$$

This implies the computation on the full diagram category.

Finally, consider $\text{res}_{K/k} \circ \text{cores}_{K/k}$. Let X' be a K -variety. Then

$$X' \times_k \text{Spec}(K) = X' \times_K (\text{Spec}(K) \times_k \text{Spec}(K)).$$

We let $S = \text{Spec}(K) \times_k \text{Spec}(K)$. It is a K -variety of dimension 0 and equal to K^d if K/k is galois of degree d . Hence the composition is induced on $\text{Pairs}^{\text{eff}}(K)$ by

$$(X', Y', i') \mapsto (X' \times_K S, Y' \times_K S, i') \mapsto H_{\text{Nori}}^{i'}(X', Y') \otimes H_{\text{Nori}}^0(S).$$

Again this implies the computation on the full diagram category. \square

Corollary 9.5.4. *Let K/k be an algebraic field extension, $K \subset k$. Then every object of $\mathcal{MM}_{\text{Nori}}(K)$ is a subquotient of an object in the image of base change from $\mathcal{MM}_{\text{Nori}}(k)$.*

Proof. By Proposition 9.5.2, it suffices to consider the case when K/k is finite. Let $M \in \mathcal{MM}_{\text{Nori}}(K)$. By Proposition 9.5.3, we have

$$\text{res}_{K/k} \text{cores}_{K/k} M = M \otimes H_{\text{Nori}}^0(\text{Spec}(K) \times_k \text{Spec}(K)).$$

The 0-dimensional K -variety $\text{Spec}(K) \times_k \text{Spec}(K)$ has at least one connected component isomorphic to $\text{Spec}(K)$ (defined by the diagonal). This allows us to represent M as a subobject of an object in the image of the restriction functor. \square

Corollary 9.5.5. *Let K/k be an algebraic extension. Let $M \in \mathcal{MM}_{\text{Nori}}(k)$ such that $\text{res}_{K/k} M$ is in the full abelian subcategory generated by $\mathbf{1}$. Then M is in the full abelian subcategory of $\mathcal{MM}_{\text{Nori}}(k)$ generated by $H_{\text{Nori}}^0(\text{Spec}(k'))$ for $K \supset k' \supset k$ finite over k .*

Proof. By Proposition 9.5.2, it suffices to consider the case when K/k is finite. Let $M \in \mathcal{MM}_{\text{Nori}}(k)$ such that $\text{res}_{K/k} M \in \langle \mathbf{1} \rangle$. Note that $\text{cores}_{K/k} \mathbf{1} = H_{\text{Nori}}^0(\text{Spec}(K))$. Hence

$$\text{cores}_{K/k} \text{res}_{K/k} M \in \langle H_{\text{Nori}}^0(\text{Spec}(K)) \rangle.$$

On the other hand, it is equal to $M \otimes H_{\text{Nori}}^0(\text{Spec}(K))$. This implies the claim because $H_{\text{Nori}}^0(\text{Spec}(K))$ is self-dual. \square

Remark 9.5.6. Even though our notation suggests that the two functors $\text{res}_{K/k}$ and $\text{cores}_{K/k}$ are adjoint (and we expect this to be true), note that we have not established this property.

We now translate our results to the Tannakian duals. We work with motives with rational coefficients from now on.

Proof of Theorem 9.1.16. Let k be field with algebraic closure \bar{k} . Fix an embedding $\bar{k} \rightarrow \mathbb{C}$. We want to establish a natural exact sequence

$$1 \rightarrow G_{\text{mot}}(\bar{k}, \mathbb{Q}) \rightarrow G_{\text{mot}}(k, \mathbb{Q}) \rightarrow \text{Gal}(\bar{k}/k) \rightarrow 1.$$

The morphism $G_{\text{mot}}(\bar{k}, \mathbb{Q}) \rightarrow G_{\text{mot}}(k, \mathbb{Q})$ is Tannaka dual to the base change from motives over k to motives over \bar{k} . In order to check that it is a closed immersion, we have to check that every motive over \bar{k} is a subquotient of the base change of a motive over k , see [DM82, Proposition 2.21]. This was established in Corollary 9.5.4.

Recall from Section 9.4 that the Tannaka dual of the category of Artin motives is $\text{Gal}(\bar{k}/k)$. The morphism $G_{\text{mot}}(k, \mathbb{Q}) \rightarrow \text{Gal}(\bar{k}/k)$ is Tannaka dual to the inclusion of the category of Artin motives into the category of all Nori motives. In order to check that the morphism is surjective, we have to check that the functor is fully faithful with image closed under subquotients, see [DM82, Proposition 2.21]. The first condition holds by definition, the second because the category of Artin motives with rational coefficients is semi-simple.

It remains to check exactness in the middle. This is equivalent to the claim that any Nori motive over k which is trivial after base change to \bar{k} is an Artin motive. This was established in Corollary 9.5.5. Note that with rational coefficients, the category $\langle \mathbf{1} \rangle$ is equivalent to the semi-simple category of \mathbb{Q} -vector spaces. \square

Remark 9.5.7. It is an open question whether $G_{\text{mot}}(\bar{k}, \mathbb{Q})$ is connected. This would be a consequence of the period conjecture, see Corollary 13.2.7.

Chapter 10

Weights and pure Nori motives

In this chapter, we explain how Nori motives relate to other categories of motives. By the work of Harrer, the realisation functor from geometric motives to absolute Hodge motives factors via Nori motives. We then use this in order to establish the existence of a weight filtration on Nori motives with rational coefficients. The category of pure Nori motives turns out to be equivalent to André's category of motives via motivated cycles.

10.1 Comparison functors

We now have three candidates for categories of mixed motives: the triangulated categories of geometric motives (see Section 6.2), and the abelian categories of absolute Hodge motives (see Definition 6.3.11) and of Nori motives (see Chapter 9).

Theorem 10.1.1. *Let k be a subfield of \mathbb{C} . The functor $R_{\mathcal{MR}}$ of Theorem 6.3.9 factors via a chain of functors*

$$C^b(\mathbb{Z}[\mathrm{Sm}]) \rightarrow DM_{\mathrm{gm}} \rightarrow D^b(\mathcal{MM}_{\mathrm{Nori}}) \rightarrow D^b(\mathcal{MM}_{\mathrm{AH}}) \subset D_{\mathcal{MR}}.$$

The proof will be given near the end of the section by putting together several steps.

Proposition 10.1.2. *Let $k \subset \mathbb{C}$.*

1. *There is a faithful tensor functor*

$$f : \mathcal{MM}_{\mathrm{Nori}} \rightarrow \mathcal{MM}_{\mathrm{AH}}$$

such that the functor $R_{\mathcal{MR}} : C^b(\mathbb{Z}[\mathrm{Sm}]) \rightarrow D_{\mathcal{MR}}$ of Theorem 6.3.15 factors via $D^b(\mathcal{MM}_{\mathrm{Nori}}) \rightarrow D^b(\mathcal{MM}_{\mathrm{AH}})$.

2. *Every object in $\mathcal{MM}_{\mathrm{AH}}$ is a subquotient of an object in the image of $\mathcal{MM}_{\mathrm{Nori}}$.*

Proof. We want to use the universal property of Nori motives. Let $\iota : k \subset \mathbb{C}$ be the fixed embedding. The assignment $A \mapsto A_\iota$ (see Definition 6.3.1) is a fibre functor on the neutral Tannakian category \mathcal{MM}_{AH} . We denote it by H_{sing}^* because it agrees with singular cohomology of $X \otimes_k \mathbb{C}$ on $A = H_{\mathcal{MR}}^*(X)$.

We need to verify that the diagram $\text{Pairs}^{\text{eff}}$ of effective pairs from Chapter 9 can be represented in \mathcal{MM}_{AH} in a manner compatible with singular cohomology. More explicitly, let X be a variety and $Y \subset X$ a subvariety. Then $[Y \rightarrow X]$ is an object of DM_{gm} . Hence, by Theorem 6.3.15 for every $i \geq 0$ there is an object

$$H_{\mathcal{MR}}^i(X, Y) := H^i R_{\mathcal{MR}}(X, Y) \in \mathcal{MR}.$$

By construction, we have

$$H_{\text{sing}}^* H_{\mathcal{MR}}^i(X, Y) = H_{\text{sing}}^i(X(\mathbb{C}), Y(\mathbb{C}); \mathbb{Q}).$$

The edges in $\text{Pairs}^{\text{eff}}$ are also induced from morphisms in DM_{gm} . Moreover, the representation is compatible with the multiplicative structure on Good^{eff} .

By the universal property of Theorem 9.1.10, this yields a functor

$$f : \mathcal{MM}_{\text{Nori}} \rightarrow \mathcal{MR}.$$

It is faithful, exact and a tensor functor. We claim that it factors via \mathcal{MM}_{AH} . As \mathcal{MM}_{AH} is closed under subquotients in \mathcal{MR} , it is enough to check this on generators. By Corollary 9.2.23, the category $\mathcal{MM}_{\text{Nori}}^{\text{eff}}$ is generated by objects of the form $H_{\text{Nori}}^i(X, Y)$ for $X = W \setminus W_\infty$ with X smooth and Y a divisor with normal crossings. Let Y_\bullet be the Čech nerve of the cover of Y by its normalisation. This is the simplicial scheme described in detail in Section 3.3.4. Let

$$C_\bullet = \text{Cone}(Y_\bullet \rightarrow X)[-1] \in C^-(\mathbb{Q}[\text{Sm}_k]).$$

Then $H_{\mathcal{MR}}^i(X, Y) = H^i R_{\mathcal{MR}}(C_\bullet)$ is an absolute Hodge motive.

Consider $X_* \in C^b(\mathbb{Z}[\text{Sm}])$. We apply Proposition 9.2.18 to $\mathcal{A} = \mathcal{MM}_{\text{Nori}}$ and $\mathcal{A} = \mathcal{MM}_{\text{AH}}$. Hence, there is an $R_{\text{Nori}}(X_*) \in D^b(\mathcal{MM}_{\text{Nori}})$ such that the underlying vector space of $H^i R_{\text{Nori}}(X_*)$ is singular cohomology. We claim that there is a natural morphism

$$f(R_{\text{Nori}}(X_*)) \rightarrow R_{\mathcal{MR}}(X_*).$$

It will automatically be a quasi-isomorphism because both compute singular cohomology of X_* .

We continue as in the proof of Proposition 9.2.18. We choose a rigidified affine cover \tilde{U}_{X_*} of X_* and a very good filtration on the cover. This induces a very good filtration on $\text{Tot}C_*(\tilde{U}_{X_*})$. This induces a double complex of very good pairs. Each very good pair may in turn be seen as a complex with

two entries. We apply $\tilde{R}_{\mathcal{M}\mathcal{R}}$ to this triple complex and take the associated simple complex. On the one hand, the result is quasi-isomorphic to $R_{\mathcal{M}\mathcal{R}}(X_*)$ because this is true in singular cohomology. On the other hand, it agrees with $f(R_{\text{Nori}}(X_*))$, also by construction.

Finally, we claim that every $M \in \mathcal{M}\mathcal{M}_{\text{AH}}$ is a subquotient of the image of a Nori motive. By definition of absolute Hodge motives, it suffices to consider M of the form $H^i R_{\mathcal{M}\mathcal{R}}(X_*)$ for $X_* \in C^b(\mathbb{Q}[\text{Sm}_k])$. We have seen that $H^i R_{\mathcal{M}\mathcal{R}}(X_*) = H^i f(R_{\text{Nori}}(X_*))$, hence M is in the image of f . \square

Remark 10.1.3. It is very far from clear whether the functor is also full or essentially surjective. The two properties are related because every object in $\mathcal{M}\mathcal{M}_{\text{AH}}$ is a subquotient of an object in the image of $\mathcal{M}\mathcal{M}_{\text{Nori}}$.

Theorem 10.1.4 (Harrer [Har16] Theorem 7.4.17). *There is an exact tensor functor*

$$C : DM_{\text{gm}} \rightarrow D^b(\mathcal{M}\mathcal{M}_{\text{Nori}})$$

such that composition with the forgetful functor

$$DM_{\text{gm}} \rightarrow D^b(\mathcal{M}\mathcal{M}_{\text{Nori}}) \rightarrow D^b(\mathbb{Z}\text{-Mod})$$

agrees with the singular realisation of geometric motives.

Remark 10.1.5. By construction, Harrer’s functor C extends the functor

$$R_{\text{Nori}} : C^b(\mathbb{Q}[\text{Sm}_k]) \rightarrow D^b(\mathcal{M}\mathcal{M}_{\text{Nori}})$$

constructed in Proposition 9.2.18.

His argument has two steps. In the affine case, he follows an idea of Nori. If $F_\bullet X$ is a good filtration on X , we denote by $C_{F_\bullet}(X)$ the complex of Nori motives induced by the filtration. A finite correspondence $T : X \times Y$ of degree d is interpreted as a multivalued morphism, i.e., a morphism $X \rightarrow S^d(Y)$ into the symmetric power. By choosing the good filtration on Y carefully using an equivariant version of the Basic Lemma, there is an isomorphism $C_{F_\bullet}(Y^d)^{S_d} \cong C_{F_\bullet}(S^d(Y))$ where S_d denotes the symmetric group, see [Har16, Theorem 4.4.5]. By functoriality we get

$$C_{F_\bullet}(Y^d)^{S_d} \cong C_{F_\bullet}(S_d(Y)) \rightarrow C_{F_\bullet}(X).$$

The summation map $\sum p_i^* : C_{F_\bullet}(Y) \rightarrow C_{F_\bullet}(Y^d)$ factors via S_d -invariants. Hence we can compose with

$$C_{F_\bullet}(Y) \rightarrow C_{F_\bullet}(Y^d)^{S_d}.$$

In the second step, this is extended to general smooth varieties via the Čech complex. The difficulty is in making this functorial for correspondences. This is surprisingly subtle. We do not try to get into the details.

Proof of Theorem 10.1.1. We combine Theorem 10.1.4 and Theorem 10.1.2. \square

As a consequence, we get an alternative proof of the rigidity of $\mathcal{M}\mathcal{M}_{\text{Nori}}$.

Corollary 10.1.6 (Harrer [Har16, Theorem 7.6.10]). *The category $\mathcal{M}\mathcal{M}_{\text{Nori}}$ is rigid in the sense of Definition 8.3.1*

Proof. We sketch the argument and refer to [Har16] for complete details. Let (X, Y, n) be a good pair. By Proposition 8.3.4, it suffices to show that $H_{\text{Nori}}^n(X, Y)$ has a strong dual. Let $M = [Y \rightarrow X][-n]$ be the complex in DM_{gm} concentrated in degrees $n - 1$ and n . Then the complex $C(M) \in D^b(\mathcal{M}\mathcal{M}_{\text{Nori}})$ is concentrated in degree 0 because this is true for singular cohomology of the good pair (X, Y, n) . Hence

$$C(M) = H_{\text{Nori}}^n(X, Y).$$

By [VSF00, Chapter V, Theorem 4.3.7], the category DM_{gm} is rigid. Hence, M has a strong dual M^\vee . Its image under C is a strong dual of $C(M)$ in $D^b(\mathcal{M}\mathcal{M}_{\text{Nori}})$. Its image under the singular realisation is dual to the singular realisation of M , which is concentrated in degree 0 and a free \mathbb{Z} -module. Hence $C(M^\vee)$ is also concentrated in degree 0. This is the strong dual of $H_{\text{Nori}}^n(X, Y)$ in $\mathcal{M}\mathcal{M}_{\text{Nori}}$. \square

Corollary 10.1.7. *View the category DM_{gm} as a diagram and singular cohomology H_{sing}^0 as a representation to $\mathbb{Z}\text{-Mod}$. Then there is a natural equivalence of abelian categories*

$$\mathcal{M}\mathcal{M}_{\text{Nori}} \cong \mathcal{C}(DM_{\text{gm}}, H_{\text{sing}}^0).$$

Proof. By Theorem 10.1.4, the representation H_{sing}^0 factors via $\mathcal{M}\mathcal{M}_{\text{Nori}}$, hence there is an exact faithful functor

$$\mathcal{C}(DM_{\text{gm}}, H_{\text{sing}}^0) \rightarrow \mathcal{M}\mathcal{M}_{\text{Nori}}.$$

On the other hand, every good pair (X, Y, n) gives rise to a complex $[Y \rightarrow X]$ in DM_{gm} and hence to an object of $\mathcal{C}(DM_{\text{gm}}, H_{\text{sing}}^0)$. This defines a representation of the diagram Good compatible with singular cohomology. By the universal property, this give a functor

$$\mathcal{M}\mathcal{M}_{\text{Nori}} \rightarrow \mathcal{C}(DM_{\text{gm}}, H_{\text{sing}}^0).$$

The two are obviously inverse to each other. \square

The original definition of the category $\mathcal{M}\mathcal{M}_{\text{Nori}}$ via one of the diagrams Pairs, Good or VGood looks somewhat arbitrary, the characterisation via DM_{gm} is completely canonical.

10.2 Weights and Nori motives

Let $k \subset \mathbb{C}$ be a subfield. We are now going to explore the connection between Grothendieck motives, André's pure motives and pure Nori motives. We work with rational coefficients throughout.

10.2.1 André's motives

Recall the categories of Grothendieck motives over k (see Definition 6.1.1) and André's category of motives using motivated cycles (see Definition 6.1.5). We view singular cohomology with rational coefficients

$$H^* : \text{GRM} \rightarrow \mathbb{Q}\text{-Mod}$$

as a representation of the diagram defined by the category GRM. By Definition 7.1.10, there is a corresponding diagram category $\mathcal{C}(\text{GRM}, H^*)$. It has a universal property by Theorem 7.1.13.

Proposition 10.2.1. 1. *The natural functor*

$$\mathcal{C}(\text{GRM}, H^*) \rightarrow \text{AM}$$

is an equivalence of categories.

2. *If the Hodge conjecture holds, then both are equivalent to the category of pure Grothendieck motives GRM and a full subcategory of \mathcal{MM}_{AH} .*

In light of this identification, André's results in [And96] can be read as an explicit description of the diagram category attached to Grothendieck motives.

Proof. 1. Every algebraic cycle is motivated, hence there is natural functor $\text{GRM} \rightarrow \text{AM}$. It is compatible with singular cohomology. By the universal property of the diagram category of Theorem 7.1.13, this induces a faithful exact functor $\mathcal{C}(\text{GRM}, H^*) \rightarrow \text{AM}$. It remains to show that it is full. Motivated cycles are generated by algebraic cycles and the inverse of the Lefschetz isomorphism. Both are morphisms in $\mathcal{C}(\text{GRM}, H^*)$, the latter because the Lefschetz isomorphism itself is algebraic.

2. We now assume the Hodge conjecture. By [Jan90, Lemma 5.5], this implies that absolute Hodge cycles agree with cycles up to homological equivalence. Equivalently, the functor $\text{GRM} \rightarrow \mathcal{MR}$ to mixed realisations is fully faithful. As it factors via AM, the inclusion $\text{GRM} \rightarrow \text{AM}$ has to be full as well. The endomorphisms of $[Y]$ for Y smooth and projective can be computed in \mathcal{MR} or AM. The algebra is semi-simple because $H_{\mathcal{MR}}^*(Y)$ is polarisable, see [Hub95, Proposition 21.1.2 and 21.2.3], or because AM is a semi-simple category, see Corollary 10.2.3. This implies that its subquotients are the same

as its direct summands. Hence, the functor from GRM to AM is essentially surjective. \square

Remark 10.2.2. Note that we encounter the same problem with tensor structures as for Grothendieck motives. The categories of Grothendieck motives and André’s motives both have a rigid tensor structure, but the natural functor is not a tensor functor because of the signs in the Künneth formula. In the language of diagrams of Section 8.1: GRM is a multiplicative diagram, but H^* is *not* a multiplicative representation.

Corollary 10.2.3. *The category $\mathcal{C}(\text{GRM}, H^*)$ is a semi-simple abelian rigid tensor category.*

Proof. This is true for AM by [And96, Théoème 0.4]. \square

10.2.2 Weights

We need to introduce weights.

We work with \mathbb{Q} -coefficients throughout this section.

Definition 10.2.4. Let $n \in \mathbb{Z}$. An object $M \in \mathcal{MM}_{\text{Nori}, \mathbb{Q}}$ is called *pure of weight n* if it is a subquotient of a motive of the form $H_{\text{Nori}}^{n+2j}(Y)(j)$ with Y smooth and projective and $j \in \mathbb{Z}$.

A motive is called *pure* if it is a direct sum of pure motives of some weights.

We denote by $\mathcal{MM}_{\text{Nori}, \mathbb{Q}}^{\text{pure}}$ the full subcategory of pure Nori motives.

In particular, $H_{\text{Nori}}^*(Y)$ is pure if Y is smooth and projective.

Theorem 10.2.5 (Arapura [Ara13, Theorems 6.3.5, 6.3.6]). *Every Nori motive $M \in \mathcal{MM}_{\text{Nori}, \mathbb{Q}}$ carries a unique bounded increasing filtration $(W_n M)_{n \in \mathbb{Z}}$ inducing the weight filtration in \mathcal{MR} . Every morphism of Nori motives is strictly compatible with the filtration.*

Arapura gives a direct proof of this result. We present a different argument based on Bondarko’s theory of weights and Harrer’s realisation functor.

Proof. As the functor $\mathcal{MM}_{\text{Nori}, \mathbb{Q}} \rightarrow \mathcal{MR}$ is faithful and exact, the filtration on $M \in \mathcal{MM}_{\text{Nori}, \mathbb{Q}}$ is indeed uniquely determined by its image in \mathcal{MR} . Strictness of morphisms, i.e., that the W_n are exact, follows from the same property in \mathcal{MR} , see Proposition 6.3.5. (Note that this is the point where we are using \mathbb{Q} -coefficients.)

We turn to existence. We use Bondarko’s weight structure on DM_{gm} , see Theorem 6.2.12. By Proposition 6.2.14, it induces a filtration on the values of any cohomological functor. We apply this to the functor of Theorem 10.1.4 from DM_{gm} to $\mathcal{MM}_{\text{Nori}, \mathbb{Q}}$. The associated gradeds are pure as mixed realisations because they are subobjects of $H_{\mathcal{MR}}^0(P[-i])$ for a Chow motive P . In particular, the weight filtration on $H_{\text{Nori}}^n(X, Y)$ is motivic for every vertex

of Pairs^{eff}. The weight filtration on subquotients is the induced filtration, hence also motivic. As any object in $\mathcal{MM}_{\text{Nori},\mathbb{Q}}^{\text{eff}}$ is a subquotient of some $H_{\text{Nori}}^n(X, Y)$, this finishes the proof in the effective case. The non-effective case follows immediately by localisation. \square

Actually, the proof gives a little more:

Corollary 10.2.6. *Let $M \in \mathcal{MM}_{\text{Nori}}$ be of the shape $H_{\text{Nori}}^i(\tilde{M})$ for a geometric motive \tilde{M} . Then $W_n M/W_{n-1} M$ is of the form*

$$\text{Ker}(H_{\text{Nori}}^n(P) \rightarrow H_{\text{Nori}}^n(P'))$$

for a morphism of Grothendieck motives $P' \rightarrow P$.

Proof. The explicit description of the weight filtration in Proposition 6.2.14 gives a morphism of Chow motives. Its image in $\mathcal{MM}_{\text{Nori}}$ only depends on the Grothendieck motives. \square

Theorem 10.2.7 (Arapura [Ara13, Theorem 6.4.1]). *1. Singular cohomology on GRM factors naturally via a (covariant) faithful functor*

$$\text{GRM} \rightarrow \text{AM} \rightarrow \mathcal{MM}_{\text{Nori},\mathbb{Q}}^{\text{pure}}.$$

2. The second functor is an equivalence of semi-simple abelian categories.

Recall (see Proposition 10.2.1) that the Hodge conjecture implies that the first functor is also an equivalence.

Proof. 1. Recall (see Theorem 6.2.11) that the opposite category of CHM is a full subcategory of the category of geometric motives DM_{gm} . Restricting the contravariant functor

$$DM_{\text{gm}} \rightarrow D^b(\mathcal{MM}_{\text{Nori}}) \xrightarrow{\oplus^{H^i}} \mathcal{MM}_{\text{Nori},\mathbb{Q}}$$

to the subcategory yields a covariant functor

$$\text{CHM} \rightarrow \mathcal{MM}_{\text{Nori},\mathbb{Q}}.$$

By definition, its image is contained in the category of pure Nori motives. Also by definition, a morphism in CHM is zero in GRM if it is zero in singular cohomology, and hence in $\mathcal{MM}_{\text{Nori},\mathbb{Q}}$. Therefore, the functor automatically factors via GRM. The induced functor is then faithful. It factors via AM by Proposition 10.2.1.

2. We use a trick inspired by Arapura’s proof. Let \mathcal{A} be the following auxiliary abelian category: its objects are triples (M, P, ϕ) where $M \in \mathcal{MM}_{\text{Nori},\mathbb{Q}}$, $P \in \text{AM}$ and ϕ is an isomorphism in $\mathcal{MM}_{\text{Nori},\mathbb{Q}}^{\text{pure}}$ between $\text{gr}_*^W M$ and P . Morphisms are given by pairs (m, p) of morphisms in $\mathcal{MM}_{\text{Nori},\mathbb{Q}}$ and AM compatible with the comparison isomorphism in $\mathcal{MM}_{\text{Nori},\mathbb{Q}}^{\text{pure}}$. Note that

the forgetful functor $(M, P, \phi) \mapsto M$ is faithful: if the component m of a morphism (m, p) vanishes, then so does the component p . It is also exact because kernels and cokernels in \mathcal{A} are computed componentwise. Let (X, Y, i) be an effective good pair (see Definition 9.1.1). It has an attached Nori motive $H_{\text{Nori}}^i(X, Y)$. By Theorem 10.2.5, there is also an attached pure Nori motive $\text{gr}_*^W H_{\text{Nori}}^i(X, Y)$. By Corollary 10.2.6, it is even in $\mathcal{C}(\text{GRM}, H^*)$, hence, by Proposition 10.2.1, they are even André motives. The same argument also works for edges of the diagram $\text{Pairs}^{\text{eff}}$. Hence we have representation

$$T : \text{Pairs}^{\text{eff}} \rightarrow \mathcal{A}$$

compatible with the singular realisation. By the universal property of the diagram category, the representation T extends to a functor

$$\mathcal{M}\mathcal{M}_{\text{Nori}, \mathbb{Q}}^{\text{eff}} = \mathcal{C}(\text{Pairs}^{\text{eff}}, H^*) \rightarrow \mathcal{A}.$$

It is a section of the natural functor $\mathcal{A} \rightarrow \mathcal{M}\mathcal{M}_{\text{Nori}, \mathbb{Q}}$ which projects an object (M, P, ϕ) to M .

Let M be a pure Nori motive. It has an image in \mathcal{A} , i.e., there is an André motive P isomorphic to it. More importantly, every morphism of pure Nori motives can be viewed as a morphism of André motives. Hence the embedding $\text{AM} \rightarrow \mathcal{M}\mathcal{M}_{\text{Nori}, \mathbb{Q}}^{\text{pure}}$ is an equivalence of categories. The category is semi-simple because this is true for André motives. \square

The relations on the level of categories can be reformulated in terms of their Tannaka duals. Recall that $G_{\text{mot}}(k) = G_{\text{mot}}(k, \mathbb{Q})$ is the Tannaka dual of the category of Nori motives with rational coefficients. We denote by $G_{\text{mot}}^{\text{pure}}(k)$ the Tannaka dual of the category of pure Nori motives with rational coefficients, or, equivalently, of AM.

Theorem 10.2.8. *Let k be a field, \bar{k} its algebraic closure and $\bar{k} \subset \mathbb{C}$ an embedding.*

1. *There is a natural exact sequence of pro-algebraic groups over \mathbb{Q}*

$$1 \rightarrow U_{\text{mot}}(k) \rightarrow G_{\text{mot}}(k) \rightarrow G_{\text{mot}}^{\text{pure}}(k) \rightarrow 1$$

with $U_{\text{mot}}(k)$ pro-unipotent and $G_{\text{mot}}^{\text{pure}}(k)$ pro-reductive. Moreover, we have $U_{\text{mot}}(k) = U_{\text{mot}}(\bar{k})$.

2. *There is a morphism of natural exact sequences*

$$\begin{array}{ccccccc} 1 & \longrightarrow & G_{\text{mot}}^{\text{pure}}(\bar{k}) & \longrightarrow & G_{\text{mot}}^{\text{pure}}(k) & \longrightarrow & \text{Gal}(\bar{k}/k) \longrightarrow 1 \\ & & \downarrow & & \downarrow & & \parallel \\ 1 & \longrightarrow & G_{\text{mot}}(\bar{k}) & \longrightarrow & G_{\text{mot}}(k) & \longrightarrow & \text{Gal}(\bar{k}/k) \longrightarrow 1 \end{array}$$

Proof. The inclusion $\mathcal{M}\mathcal{M}_{\text{Nori},\mathbb{Q}}^{\text{pure}} \rightarrow \mathcal{M}\mathcal{M}_{\text{Nori}}$ is fully faithful and closed under subquotients. By [DM82, Proposition 2.21], this implies that $G_{\text{mot}}(k) \rightarrow G_{\text{mot}}^{\text{pure}}(k)$ is surjective. We define $U_{\text{mot}}(k)$ as the kernel. By [DM82, Proposition 2.23], the Tannaka dual is pro-reductive if and only if the category is semi-simple. This is the case for AM. Indeed, it is the maximal semi-simple subcategory of $\mathcal{M}\mathcal{M}_{\text{Nori},\mathbb{Q}}$ because every object admits a weight filtration.

The second exact sequence was established in Theorem 9.1.16. The exact sequence for pure motives is due to André, see [And96, Section 4.6]. In both cases the inclusion is induced by the base change from k to \bar{k} and the projection to the Galois group by the inclusion of Artin motives into all motives. Hence the diagram commutes. Actually, the exactness of the sequence for pure motives can also be deduced from the second sequence because the base change of pure motive is pure and Artin motives are pure of weight zero.

Finally, we compare $U_{\text{mot}}(k)$ and $U_{\text{mot}}(\bar{k})$ via the commutative diagram

$$\begin{array}{ccccccc}
 & & U_{\text{mot}}(\bar{k}) & \longrightarrow & U_{\text{mot}}(k) & & \\
 & & \downarrow & & \downarrow & & \\
 1 & \longrightarrow & G_{\text{mot}}(\bar{k}) & \longrightarrow & G_{\text{mot}}(k) & \longrightarrow & \text{Gal}(\bar{k}/k) \longrightarrow 1 \\
 & & \downarrow & & \downarrow & & \downarrow = \\
 1 & \longrightarrow & G_{\text{mot}}^{\text{pure}}(\bar{k}) & \longrightarrow & G_{\text{mot}}^{\text{pure}}(k) & \longrightarrow & \text{Gal}(\bar{k}/k) \longrightarrow 1
 \end{array}$$

Hence the unipotent parts over k and \bar{k} agree. □

Remark 10.2.9. We will show in Corollary 13.2.7 that under the assumption of the period conjecture, the group $G_{\text{mot}}(\bar{k})$ is connected. On the other hand $\text{Gal}(\bar{k}/k)$ is totally disconnected. Hence, at least conjecturally, $G_{\text{mot}}(\bar{k})$ is the connected component of the unit in $G_{\text{mot}}(k)$.

10.3 Tate motives

We discuss the subcategory of mixed Tate motives for completeness, even though we have very little to say. We work with rational coefficients throughout

Definition 10.3.1. Let k be a subfield of \mathbb{C} . The category of *mixed Tate Nori motives* $\mathcal{MT}\mathcal{M}_{\text{Nori},\mathbb{Q}}$ is defined as the full abelian subcategory of $\mathcal{M}\mathcal{M}_{\text{Nori},\mathbb{Q}}$ closed under extensions which contains all Tate objects $\mathbf{1}(n)$ for $n \in \mathbb{Z}$. The category of *pure Tate Nori motives* $\mathcal{TM}_{\text{Nori},\mathbb{Q}}$ is defined as the full abelian subcategory of $\mathcal{MT}\mathcal{M}_{\text{Nori},\mathbb{Q}}$ containing only pure motives.

The category of pure Tate motives is the expected one and the same as in any other setting of motives.

Lemma 10.3.2. *A Nori motive $M \in \mathcal{MM}_{\text{Nori}, \mathbb{Q}}$ is a mixed Tate motive if and only if the weight graded pieces $\text{gr}_n^W M$ are of the form $\mathbf{1}(n/2)^{N_n}$ for some N_n .*

The category $\mathcal{TM}_{\text{Nori}, \mathbb{Q}}$ is equivalent to the category of graded \mathbb{Q} -vector spaces.

Proof. Consider the full subcategory of $\mathcal{MM}_{\text{Nori}, \mathbb{Q}}$ of objects with weight gradings which have the shape of the lemma. Such objects are iterated extension of objects of the form $\mathbf{1}(i)$, i.e., mixed Tate. The category is abelian because the functors gr_n^W are exact and the category of pure motives is semi-simple. Moreover, the category is closed under extensions. Hence it agrees with $\mathcal{MTM}_{\text{Nori}, \mathbb{Q}}$.

A motive M is pure if agrees with $\bigoplus_{n \in \mathbb{Z}} \text{gr}_n^W M$. Hence a pure Tate motive is direct sum of objects of $\mathbf{1}(i)$. Morphisms respect the grading because this is true in the Hodge realisation. \square

Recall, on the other hand, the “true” category of mixed Tate motives, see Definition 6.4.2.

Proposition 10.3.3. *The mixed realisation functor $H_{\mathcal{MR}}^0 : \mathcal{MTM}_{\text{gm}} \rightarrow \mathcal{MM}_{\text{AH}}$ factors via $\mathcal{MTM}_{\text{Nori}, \mathbb{Q}}$. It is fully faithful with image closed under subquotients.*

Proof. In order to show the factorisation, it suffices to consider pure Tate motives. The realisation functor maps $\mathbb{Q}(i)$ to $\mathbf{1}(-i)$, hence it factors via $\mathbf{1}(-i) \in \mathcal{MTM}_{\text{Nori}, \mathbb{Q}}$.

Full faithfulness was shown for $H_{\mathcal{MR}}^0$ in Proposition 6.4.5. As the functor $\mathcal{MTM}_{\text{Nori}, \mathbb{Q}} \rightarrow \mathcal{MR}$ is faithful, it also follows that the functor $\mathcal{MTM}_{\text{gm}} \rightarrow \mathcal{MTM}_{\text{Nori}, \mathbb{Q}}$ is full. The statement on subquotients follows as in loc. cit. \square

Remark 10.3.4. In particular,

$$\text{Ext}_{\mathcal{MTM}_{\text{Nori}, \mathbb{Q}}}^1(M, N) \subset \text{Ext}_{\mathcal{MM}_{\text{AH}}}^1(M_{\mathcal{MR}}, N_{\text{AH}}).$$

However, we neither know whether the inclusion is full nor whether there are higher Ext-groups.

As mentioned in Section 6.4, a variant of the category is needed in the context of conjectures on special values of L -functions (see Section 16.1), or multiple zeta values (see Chapter 15). We actually need a smaller category. In the following, we restrict to the essential case $k = \mathbb{Q}$.

Definition 10.3.5. Let $k = \mathbb{Q}$. A mixed Tate motive M is called *unramified* if for primes p , the Galois realisation M_p is completely unramified, i.e., for all primes $l \neq p$, the inertia group $I_l \subset \text{Gal}(\bar{\mathbb{Q}}/\mathbb{Q})$ acts trivially and M_p is crystalline as a representation of $\text{Gal}(\bar{\mathbb{Q}}_p/\mathbb{Q}_p)$. Let $\mathcal{MTM}_{\text{Nori}, \mathbb{Q}}^f$ be the category of *unramified mixed Tate motives*.

Remark 10.3.6. In the literature, analogous categories also go by the name of *motives over \mathbb{Z}* . Heuristically, we want motives over \mathbb{Q} which have a preimage in the category of motives over \mathbb{Z} . The above definition is an unconditional replacement.

Lemma 10.3.7. 1. *Pure Tate motives are unramified.*

2. *The category of unramified mixed Tate motives is closed under subquotients in $\mathcal{MTM}_{\text{Nori},\mathbb{Q}}$, in particular it is abelian.*

Proof. This is a statement about the representation of $\text{Gal}(\bar{\mathbb{Q}}/\mathbb{Q})$ on \mathbb{Q}_p via the cyclotomic character. It is well-known. Let M be an unramified mixed Tate motive and $N \subset M$ a submotive. Then $N_p \subset M_p$. By assumption, the inertia group acts trivially on M_p , hence it also acts trivially on N_p . The same argument also works for quotients. Moreover, it is known that being crystalline is stable under subquotients. \square

The whole point of the definition is to cut down the number of extensions between pure Tate motives.

We now turn to the comparison with geometric motives. Let \mathcal{MTM}^f be the subcategory of Tate motives unramified over \mathbb{Z} defined by Deligne and Goncharov, see Definition 6.4.6.

Proposition 10.3.8. *The realisation functor $\mathcal{MTM}_{\text{gm}} \rightarrow \mathcal{MTM}_{\text{Nori},\mathbb{Q}}$ maps the subcategory \mathcal{MTM}^f to $\mathcal{MTM}_{\text{Nori},\mathbb{Q}}^f$.*

Proof. The realisation functor maps $\mathbb{Q}(i)$ to $\mathbf{1}(-i)$. Hence mixed Tate motives are mapped to mixed Tate motives. The ramification condition of Deligne–Goncharov implies ours by Proposition 6.4.7. \square

Part III
Periods

Chapter 11

Periods of varieties

A period, or more precisely, a period number may be thought of as the value of an integral that occurs in a geometric context. In their papers [Kon99] and [KZ01], Kontsevich and Zagier list various ways of defining a period.

It is stated in their papers, without reference, that all these variants give the same definition. We give a proof of this statement in the Period Theorem 12.2.1.

11.1 First definition

We start with the simplest definition. In this section, let $k \subset \mathbb{C}$ be a subfield.

For this definition, the following data is needed:

- X a smooth algebraic variety of dimension d , defined over k ,
- D a divisor on X with normal crossings, also defined over k ,
- $\omega \in \Gamma(X, \Omega_{X/k}^d)$ an algebraic differential form of top degree,
- Γ a relative differentiable singular d -chain on X^{an} with $\partial\Gamma$ on D^{an} , i.e.,

$$\Gamma = \sum_{i=1}^n \alpha_i \gamma_i$$

with $\alpha_i \in \mathbb{Q}$, $\gamma_i : \Delta_d \rightarrow X^{\text{an}}$ a map which can be extended to a C^∞ -map of a neighbourhood of $\Delta_d \subset \mathbb{R}^{d+1}$ for all i and $\partial\Gamma$ a chain on D^{an} as in Definition 2.2.2.

As before, we denote by X^{an} the analytic space attached to $X(\mathbb{C})$.

Definition 11.1.1 (NC-periods). Let $k \subset \mathbb{C}$ be a subfield.

1. Let (X, D, ω, Γ) be as above. We will call the complex number

$$\int_{\Gamma} \omega = \sum_{i=1}^n \alpha_i \int_{\Delta_d} \gamma_i^* \omega$$

the *period* of the quadruple (X, D, ω, Γ) .

2. The *algebra of effective periods* $\mathbb{P}_{\text{nc}}^{\text{eff}} = \mathbb{P}_{\text{nc}}^{\text{eff}}(k)$ over k is the set of all period numbers for all (X, D, ω, Γ) defined over k .
3. The *period algebra* $\mathbb{P}_{\text{nc}} = \mathbb{P}_{\text{nc}}(k)$ over k is the set of numbers of the form $(2\pi i)^n \alpha$ with $n \in \mathbb{Z}$ and $\alpha \in \mathbb{P}_{\text{nc}}^{\text{eff}}$.

Remark 11.1.2. 1. The subscript nc refers to the normal crossing divisor D in the above definition.

2. We will show a bit later (see Proposition 11.1.7) that $\mathbb{P}_{\text{nc}}^{\text{eff}}(k)$ is indeed an algebra.
3. Moreover, we will see in the next example that $2\pi i \in \mathbb{P}_{\text{nc}}^{\text{eff}}$. This means that \mathbb{P}_{nc} is nothing but the localisation

$$\mathbb{P}_{\text{nc}} = \mathbb{P}_{\text{nc}}^{\text{eff}} \left[\frac{1}{2\pi i} \right].$$

4. This definition was motivated by Kontsevich's discussion of formal effective periods [Kon99, Definition 20, p. 62]. For an extensive discussion of formal periods and their precise relation to periods, see Chapter 13.

Example 11.1.3. Let $X = \mathbb{A}_{\mathbb{Q}}^1$ be the affine line and $\omega = dt \in \Omega^1$. Let $D = V(t^3 - 2t)$. Let $\gamma : [0, 1] \rightarrow \mathbb{A}_{\mathbb{Q}}^1(\mathbb{C}) = \mathbb{C}$ be the line from 0 to $\sqrt{2}$. This is a singular chain with boundary in $D(\mathbb{C}) = \{0, \pm\sqrt{2}\}$. Hence it defines a class in $H_1^{\text{sing}}(\mathbb{A}^{1, \text{an}}, D^{\text{an}}; \mathbb{Q})$. We obtain the period

$$\int_{\gamma} \omega = \int_0^{\sqrt{2}} dt = \sqrt{2}.$$

The same method works for all algebraic numbers.

Example 11.1.4. Let $X = \mathbb{G}_m = \mathbb{A}^1 \setminus \{0\}$, $D = \emptyset$ and $\omega = \frac{1}{t} dt$. We choose $\gamma : S^1 \rightarrow \mathbb{G}_m(\mathbb{C}) = \mathbb{C}^*$ to be the unit circle. It defines a class in $H_1^{\text{sing}}(\mathbb{C}^*, \mathbb{Q})$. We obtain the period

$$\int_{S^1} t^{-1} dt = 2\pi i.$$

In particular, $\pi \in \mathbb{P}_{\text{nc}}^{\text{eff}}(k)$ for all k .

Example 11.1.5. Let $X = \mathbb{G}_m$, $D = V((t-2)(t-1))$, $\omega = t^{-1} dt$, and γ the line from 1 to 2. We obtain the period

$$\int_1^2 t^{-1} dt = \log(2).$$

For more advanced examples, see Part IV.

Lemma 11.1.6. *Let (X, D, ω, Γ) be as before. The period number $\int_{\Gamma} \omega$ depends only on the cohomology class of ω in relative de Rham cohomology and on the cohomology class of Γ in relative singular homology.*

Proof. The restriction of ω to the analytification D_j^{an} of some irreducible component D_j of D is a holomorphic d -form on a complex manifold of dimension $d - 1$, hence zero. Therefore the integral $\int_{\Delta} \omega$ evaluates to zero for smooth singular simplices Δ that are supported on D .

If Γ', Γ'' are two representatives of the same relative singular homology class, we have

$$\Gamma' - \Gamma'' \sim \partial(\Gamma_{d+1})$$

modulo simplices living on some D_j^{an} for a smooth singular chain Γ_{d+1} of dimension $d + 1$

$$\Gamma_{d+1} \in C_{d+1}^{\infty}(X^{\text{an}}, D^{\text{an}}; \mathbb{Q}).$$

Using Stokes' theorem, we get

$$\int_{\Gamma'} \omega - \int_{\Gamma''} \omega = \int_{\partial(\Gamma_{d+1})} \omega = \int_{\Gamma_{d+1}} d\omega = 0,$$

since ω is closed. By a similar argument, the integral only depends on the class of ω . \square

In the course of this chapter, we are also going to prove the converse: every pair of relative cohomology classes gives rise to a period number.

Proposition 11.1.7. *The sets $\mathbb{P}_{\text{nc}}^{\text{eff}}(k)$ and $\mathbb{P}_{\text{nc}}(k)$ are k -algebras. Moreover, $\mathbb{P}_{\text{nc}}^{\text{eff}}(K) = \mathbb{P}_{\text{nc}}^{\text{eff}}(k)$ if K/k is algebraic.*

Proof. Let (X, D, ω, Γ) and $(X', D', \omega', \Gamma')$ be two quadruples as in the definition of normal crossing periods.

By multiplying ω by an element of k , we obtain k -multiples of periods.

The product of the two periods is realised by the quadruple $(X \times X', D \times X' \cup X \times D', \omega \wedge \omega', \Gamma \times \Gamma')$.

Note that the quadruple $(\mathbb{A}^1, \{0, 1\}, dt, [0, 1])$ has period 1. By multiplying by this factor, we do not change the period number of a quadruple, but we change its dimension. Hence we can assume that X and X' have the same dimension. The sum of their periods is then realised on the disjoint union $(X \cup X', D \cup D', \omega + \omega', \Gamma + \Gamma')$.

If K/k is a finite algebraic extension, then we obviously have $\mathbb{P}_{\text{nc}}^{\text{eff}}(k) \subset \mathbb{P}_{\text{nc}}^{\text{eff}}(K)$. For the converse, consider a quadruple (X, D, ω, Γ) over K . We may also view X as a k -variety and write X_k for distinction. By Lemma 3.1.13 or more precisely its proof, ω can also be viewed as a differential form on X_k/k . The complex points $X_k(\mathbb{C})$ consist of $[K : k]$ copies of the complex points $X(\mathbb{C})$. Let Γ_k be the cycle Γ on one of them. Then the period of (X, D, ω, Γ) is the same as the period of $(X_k, D_k, \omega, \Gamma_k)$. This gives the converse inclusion.

If K/k is infinite, but algebraic, we obviously have $\mathbb{P}_{\text{nc}}^{\text{eff}}(K) = \bigcup_L \mathbb{P}_{\text{nc}}^{\text{eff}}(L)$ with L running through all fields $K \supset L \supset k$ finite over k . Hence, equality also holds in the general case. \square

11.2 Periods for the category $(k, \mathbb{Q})\text{-Vect}$

For a clean development of the theory of period numbers, it is advantageous to formalise the data. Recall from Section 5.1 the category $(k, \mathbb{Q})\text{-Vect}$. Its objects consist of a k -vector space V_k and a \mathbb{Q} -vector space $V_{\mathbb{Q}}$ linked by an isomorphism $\phi_{\mathbb{C}} : V_k \otimes_k \mathbb{C} \rightarrow V_{\mathbb{Q}} \otimes_{\mathbb{Q}} \mathbb{C}$. This is precisely what we need in order to define periods abstractly.

Definition 11.2.1.

1. Let $V = (V_k, V_{\mathbb{Q}}, \phi_{\mathbb{C}})$ be an object of $(k, \mathbb{Q})\text{-Vect}$. A *period matrix* of V is the matrix of $\phi_{\mathbb{C}}$ with respect to a choice of bases v_1, \dots, v_n of V_k and w_1, \dots, w_n of $V_{\mathbb{Q}}$, respectively. A complex number is a *period* of V if it is an entry of a period matrix of V for some choice of bases. The set of periods of V together with the number 0 is denoted $\mathbb{P}(V)$. We denote by $\mathbb{P}\langle V \rangle$ the k -subvector space of \mathbb{C} generated by the entries of the period matrix.
2. Let $\mathcal{C} \subset (k, \mathbb{Q})\text{-Vect}$ be a subcategory. We denote by $\mathbb{P}(\mathcal{C})$ the set of periods for all objects in \mathcal{C} .

Remark 11.2.2.

1. Any object $V = (V_k, V_{\mathbb{Q}}, \phi_{\mathbb{C}})$ gives rise to a bilinear map

$$V_k \times V_{\mathbb{Q}}^{\vee} \rightarrow \mathbb{C} : (v, \lambda) \mapsto \lambda(\phi_{\mathbb{C}}^{-1}(v \otimes 1)),$$

where we have extended $\lambda : V_{\mathbb{Q}} \rightarrow \mathbb{Q} \subset \mathbb{C}$ -linearly to $V_{\mathbb{Q}} \otimes_{\mathbb{Q}} \mathbb{C} \rightarrow \mathbb{C}$. The periods of V are the numbers in its image. Note that this image is a set, not a vector space in general. The period matrix depends on the choice of bases, but the vector space $\mathbb{P}\langle V \rangle$ does not.

2. The definition of $\mathbb{P}(\mathcal{C})$ does not depend on the morphisms. If the category has only one object, the second definition specialises to the first.

Lemma 11.2.3. *Let $\mathcal{C} \subset (k, \mathbb{Q})\text{-Vect}$ be a subcategory.*

1. $\mathbb{P}(\mathcal{C})$ is closed under multiplication by k .
2. If \mathcal{C} is additive, then $\mathbb{P}(\mathcal{C})$ is a k -vector space.
3. If \mathcal{C} is a tensor subcategory, then $\mathbb{P}(\mathcal{C})$ is a k -algebra.

Proof. Multiplying a basis element w_i by an element α in k multiplies the periods by α . Hence the set is closed under multiplication by elements of k^* .

Let p be a period of V and p' a period of V' . Then $p + p'$ is a period of $V \oplus V'$. If \mathcal{C} is additive, then $V, V' \in \mathcal{C}$ implies $V \oplus V' \in \mathcal{C}$. Moreover, pp' is

a period of $V \otimes V'$. If \mathcal{C} is a tensor subcategory of $(k, \mathbb{Q})\text{-Vect}$, then $V \otimes V'$ is also in \mathcal{C} . \square

Proposition 11.2.4. *Let $\mathcal{C} \subset (k, \mathbb{Q})\text{-Vect}$ be a subcategory.*

1. *Let $\langle \mathcal{C} \rangle$ be the smallest full abelian subcategory of $(k, \mathbb{Q})\text{-Vect}$ closed under subquotients and containing \mathcal{C} . Then $\mathbb{P}(\langle \mathcal{C} \rangle)$ is the abelian subgroup of \mathbb{C} generated by $\mathbb{P}(\mathcal{C})$.*
2. *Let $\langle \mathcal{C} \rangle^{\otimes}$ be the smallest full abelian subcategory of $(k, \mathbb{Q})\text{-Vect}$ closed under subquotients and tensor products and containing \mathcal{C} . Then $\mathbb{P}(\langle \mathcal{C} \rangle^{\otimes})$ is the (possibly non-unital) subring of \mathbb{C} generated by $\mathbb{P}(\mathcal{C})$.*

Proof. The period algebra $\mathbb{P}(\mathcal{C})$ only depends on objects. Hence we can replace \mathcal{C} by the full subcategory with the same objects without changing the period algebra.

Moreover, if $V \in \mathcal{C}$ and $V' \subset V$ in $(k, \mathbb{Q})\text{-Vect}$, then we can extend any basis for V' to a basis to V . In this form, the period matrix for V is block triangular with one of the blocks the period matrix of V' . This implies

$$\mathbb{P}(V') \subset \mathbb{P}(V).$$

Hence, $\mathbb{P}(\mathcal{C})$ does not change if we add all subobjects (in $(k, \mathbb{Q})\text{-Vect}$) of objects of \mathcal{C} to \mathcal{C} . The same argument also implies that $\mathbb{P}(\mathcal{C})$ does not change if we add quotients in $(k, \mathbb{Q})\text{-Vect}$.

After these reductions, the only thing missing to make \mathcal{C} additive is the existence of direct sums. If V and V' are objects of \mathcal{C} , then the periods of $V \oplus V'$ are sums of periods of V and periods of V' . Hence adding direct sums to \mathcal{C} amounts to passing from $\mathbb{P}(\mathcal{C})$ to the abelian group generated by it. It is automatically a k -vector space.

If V and V' are objects of \mathcal{C} , then the periods of $V \otimes V'$ are sums of products of periods of V and periods of V' . Hence closing \mathcal{C} up under tensor products (and their subquotients) amounts to passing to the ring generated by $\mathbb{P}(\mathcal{C})$. \square

So far, we fixed the ground field k . We now want to study the behaviour under change of fields.

Definition 11.2.5. Let K/k be a finite extension of subfields of \mathbb{C} . Let

$$-\otimes_k K : (k, \mathbb{Q})\text{-Vect} \rightarrow (K, \mathbb{Q})\text{-Vect}, \quad (V_k, V_{\mathbb{Q}}, \phi_{\mathbb{C}}) \mapsto (V_k \otimes_k K, V_{\mathbb{Q}}, \phi_{\mathbb{C}})$$

be the *extension of scalars*.

Lemma 11.2.6. *Let K/k be a finite extension of subfields of \mathbb{C} . Let $V \in (k, \mathbb{Q})\text{-Vect}$. Then*

$$\mathbb{P}(V \otimes_k K) = \mathbb{P}(V) \otimes_k K.$$

Proof. The period matrix for V agrees with the period matrix for $V \otimes_k K$. On the left-hand side, we pass to the K -vector space generated by its entries. On the right-hand side, we first pass to the k -vector space generated by its entries, and then extend scalars. \square

Conversely, there is a *restriction of scalars* where we view a K -vector space V_K as a k -vector space.

Lemma 11.2.7. *Let K/k be a finite extension of subfields of \mathbb{C} . Then the functor $-\otimes_k K$ has a right adjoint*

$$R_{K/k} : (K, \mathbb{Q})\text{-Vect} \rightarrow (k, \mathbb{Q})\text{-Vect}.$$

For $W \in (K, \mathbb{Q})\text{-Vect}$ we have

$$\mathbb{P}\langle W \rangle = \mathbb{P}\langle R_{K/k}W \rangle.$$

Proof. Choose a k -basis e_1, \dots, e_n of K . We put

$$R_{K/k} : (K, \mathbb{Q})\text{-Vect} \rightarrow (k, \mathbb{Q})\text{-Vect} : (W_K, W_{\mathbb{Q}}, \phi_{\mathbb{C}}) \mapsto (W_K, W_{\mathbb{Q}}^{[K:k]}, \psi_{\mathbb{C}}),$$

where

$$\psi_{\mathbb{C}} : W_K \otimes_k \mathbb{C} \cong W_K \otimes_k K \otimes_K \mathbb{C} \cong (W_K \otimes_K \mathbb{C})^{[K:k]} \rightarrow (W_{\mathbb{Q}} \otimes_{\mathbb{Q}} \mathbb{C})^{[K:k]}$$

maps elements of the form $w \otimes e_i$ with $w \in W_K \otimes_K \mathbb{C}$ to $\phi_{\mathbb{C}}(w)$ in the i -component.

It is easy to check the universal property. We describe the unit and the counit. The natural map

$$V \rightarrow R_{K/k}(V \otimes_k K)$$

is given on the component V_k by the natural inclusion $V_k \rightarrow V_k \otimes_k K$. In order to describe it on the \mathbb{Q} -component, decompose $1 = \sum_{i=1}^n a_i e_i$ in K and put

$$V_{\mathbb{Q}} \rightarrow V_{\mathbb{Q}}^n \quad v \mapsto (a_i v)_{i=1}^n.$$

The natural map

$$(R_{K/k}W) \otimes_k K \rightarrow W$$

is given on the K -component as the multiplication map

$$W_K \otimes_k K \rightarrow W_K$$

and on the \mathbb{Q} -component

$$W_{\mathbb{Q}}^n \rightarrow W_{\mathbb{Q}}$$

by summation.

This proves the existence of the right adjoint. In particular, $R_{K/k}W$ is functorial and independent of the choice of basis.

In order to compute periods, we have to choose bases. Fix a \mathbb{Q} -basis x_1, \dots, x_n of $W_{\mathbb{Q}}$. This also defines a \mathbb{Q} -basis for $W_{\mathbb{Q}}^n$ in the obvious way. Fix a K -basis y_1, \dots, y_n of W_K . Multiplying by e_1, \dots, e_n , we obtain a k -basis of W_K . The entries of the period matrix of W are the coefficients of $\phi_{\mathbb{C}}(y_j)$ in the basis x_l . The entries of the period matrix of $R_{K/k}W$ are the coefficients of $\phi_{\mathbb{C}}(e_i y_j)$ in the basis x_l . Hence, the K -linear span of the former agrees with the k -linear span of the latter. \square

Recall from Example 5.1.4 the object $L(\alpha) \in (k, \mathbb{Q})\text{-Vect}$ for a complex number $\alpha \in \mathbb{C}^*$. It is given by the data (k, \mathbb{Q}, α) . It is invertible for the tensor structure.

Definition 11.2.8. Let $L(\alpha) \in (k, \mathbb{Q})\text{-Vect}$ be invertible. We call a bilinear pairing in $(k, \mathbb{Q})\text{-Vect}$

$$V \times W \rightarrow L(\alpha)$$

perfect if it is non-degenerate in the k - and \mathbb{Q} -components. Equivalently, the pairing induces an isomorphism

$$V \cong W^{\vee} \otimes L(\alpha),$$

where $(\cdot)^{\vee}$ denotes the dual in $(k, \mathbb{Q})\text{-Vect}$.

Lemma 11.2.9. *Assume that*

$$V \times W \rightarrow L(\alpha)$$

is a perfect pairing. Then

$$\mathbb{P}\langle V, W, V^{\vee}, W^{\vee} \rangle^{\oplus, \otimes} \subset \mathbb{P}\langle V, W \rangle^{\oplus, \otimes}[\alpha^{-1}].$$

Proof. By Proposition 11.2.4, the left-hand side is the ring generated by $\mathbb{P}(V)$, $\mathbb{P}(W)$, $\mathbb{P}(V^{\vee})$ and $\mathbb{P}(W^{\vee})$. Hence we need to show that $\mathbb{P}(V^{\vee})$ and $\mathbb{P}(W^{\vee})$ are contained in the right-hand side. This is true because $W^{\vee} \cong V \otimes L(\alpha^{-1})$ and $\mathbb{P}(V \otimes L(\alpha^{-1})) = \alpha^{-1}\mathbb{P}(V)$. \square

11.3 Periods of algebraic varieties

11.3.1 Definition

Recall from Definition 9.1.1 the directed graph of effective pairs $\text{Pairs}^{\text{eff}}$. Its vertices are triples (X, D, j) with X a variety, D a closed subvariety and j an integer. The edges are not of importance for the consideration of periods.

Now we define *cohomological periods*. For simplicity, we will call them simply *periods* in the sequel.

Definition 11.3.1 (Cohomological Periods). Let (X, D, j) be a vertex of the diagram $\text{Pairs}^{\text{eff}}$.

1. The *set of periods* $\mathbb{P}(X, D, j)$ is the image of the period pairing of Definitions 5.3.1 and 5.5.4

$$\text{per} : H_{\text{dR}}^j(X, D) \times H_j^{\text{sing}}(X^{\text{an}}, D^{\text{an}}; \mathbb{Q}) \rightarrow \mathbb{C}.$$

2. In the same situation, the *space of periods* $\mathbb{P}\langle X, D, j \rangle$ is the \mathbb{Q} -vector space generated by $\mathbb{P}(X, D, j)$.
3. Let S be a set of vertices in $\text{Pairs}^{\text{eff}}(k)$. We define the *set of periods* $\mathbb{P}(S)$ as the union of the $\mathbb{P}(X, D, j)$ for (X, D, j) in S and the *k-space of periods* $\mathbb{P}\langle S \rangle$ as the sum of the $\mathbb{P}\langle X, D \rangle$ for $(X, D, j) \in S$.
4. The *effective period algebra* $\mathbb{P}^{\text{eff}}(k)$ of k is defined as $\mathbb{P}(S)$ where S is the set of (isomorphism classes of) all vertices (X, D, j) .
5. The *period algebra* $\mathbb{P}(k)$ of k is defined as the set of complex numbers of the form $(2\pi i)^n \alpha$ with $n \in \mathbb{Z}$ and $\alpha \in \mathbb{P}^{\text{eff}}(k)$.

Remark 11.3.2. Note that $\mathbb{P}(X, D, j)$ is closed under multiplication by elements in k but not under addition. However, $\mathbb{P}^{\text{eff}}(k)$ is indeed an algebra by Corollary 11.3.5 below. This means that $\mathbb{P}(k)$ is nothing but the localisation

$$\mathbb{P}(k) = \mathbb{P}^{\text{eff}}(k) \left[\frac{1}{2\pi i} \right].$$

Passing to this localisation is very natural from the point of view of motives: it corresponds to passing from periods of effective motives to periods of all mixed motives. For more details, see Chapter 6.

Example 11.3.3. Let $X = \mathbb{P}_k^n$. Then $(\mathbb{P}_k^n, \emptyset, 2j)$ has period set $(2\pi i)^j k^\times$. The easiest way to see this is by computing the motive of \mathbb{P}_k^n , e.g., in Lemma 9.3.8. The motive of $(\mathbb{P}_k^n, \emptyset, 2j)$ is given by $\mathbf{1}(-j)$. By compatibility with the tensor product, it suffices to consider the case $j = 1$ where the same motive can be defined from the pair $(\mathbb{G}_m, \emptyset, 1)$. It has the period $2\pi i$ by Example 11.1.4. The factor k^\times appears because we may multiply the basis vector in de Rham cohomology by a factor in k^\times .

Recall from Theorem 5.3.4 and Theorem 5.5.6 that we have an explicit description of the period isomorphism by integration.

Lemma 11.3.4. *There are natural inclusions $\mathbb{P}_{\text{nc}}^{\text{eff}}(k) \subset \mathbb{P}^{\text{eff}}(k)$ and $\mathbb{P}_{\text{nc}}(k) \subset \mathbb{P}(k)$.*

Proof. By definition, it suffices to consider the effective case. By Lemma 11.1.6, the period in $\mathbb{P}_{\text{nc}}^{\text{eff}}(k)$ only depends on the cohomology class. By Theorem 3.3.19, the period in $\mathbb{P}^{\text{eff}}(k)$ is defined by integration, i.e., by the formula in the definition of $\mathbb{P}_{\text{nc}}^{\text{eff}}(k)$. \square

The converse inclusion is deeper, see Theorem 11.4.2.

11.3.2 First properties

Recall from Definition 5.4.2 that there is a representation

$$H : \text{Pairs}^{\text{eff}} \rightarrow (k, \mathbb{Q})\text{-Vect}$$

where the category $(k, \mathbb{Q})\text{-Vect}$ was introduced in Section 5.1. The component corresponding to k is given by algebraic de Rham cohomology. The \mathbb{Q} -component is given by singular cohomology with rational coefficients. They are related by the period isomorphism. By construction, we have

$$\begin{aligned} \mathbb{P}(X, D, j) &= \mathbb{P}(H(X, D, j)), \\ \mathbb{P}\langle X, D, j \rangle &= \mathbb{P}\langle H(X, D, j) \rangle, \\ \mathbb{P}^{\text{eff}}(k) &= \mathbb{P}(H(\text{Pairs}^{\text{eff}})). \end{aligned}$$

This means that we can apply the abstract considerations of Section 5.1 to our period algebras.

Corollary 11.3.5. 1. $\mathbb{P}^{\text{eff}}(k)$ and $\mathbb{P}(k)$ are k -subalgebras of \mathbb{C} .

2. If K/k is an algebraic extension of subfields of K , then $\mathbb{P}^{\text{eff}}(K) = \mathbb{P}^{\text{eff}}(k)$ and $\mathbb{P}(K) = \mathbb{P}(k)$.

3. If k is countable, then so is $\mathbb{P}(k)$.

Proof. 1. It suffices to consider the effective case. The image of H is closed under direct sums because direct sums are realised by disjoint unions of effective pairs. As in the proof of Proposition 11.1.7, we can use $(\mathbb{A}^1, \{0, 1\}, 1)$ in order to shift the cohomological degree without changing the periods.

The image of H is also closed under tensor products. Hence its period set is a k -algebra by Lemma 11.2.3.

2. Let K/k be finite. For (X, D, i) over k , we have the base change (X_K, D_K, i) over K . By compatibility of the de Rham realisation with base change (see Lemma 3.2.14), we have

$$H(X, D, i) \otimes K = H(X_K, D_K, i).$$

By Lemma 11.2.6, this implies that the periods of (X, D, j) are contained in the periods of the base change. Hence $\mathbb{P}^{\text{eff}}(k) \subset \mathbb{P}^{\text{eff}}(K)$.

Conversely, if (Y, E, m) is defined over K , we may view it as defined over k via the map $\text{Spec}(K) \rightarrow \text{Spec}(k)$. We write (Y_k, E_k, m) in order to avoid confusion. Note that $Y_k(\mathbb{C})$ consists of $[K : k]$ many copies of $Y(\mathbb{C})$. Moreover, by Lemma 3.2.15, de Rham cohomology of Y/K agrees with de Rham cohomology of Y_k/k . Hence

$$H(Y_k, E_k, m) = R_{K/k}H(Y, E, m)$$

and their period sets agree by Lemma 11.2.7. Hence, we also have $\mathbb{P}^{\text{eff}}(K) \subset \mathbb{P}^{\text{eff}}(k)$.

3. Let k be countable. For each triple (X, D, j) , the cohomologies $H_{\text{dR}}^j(X)$ and $H_j^{\text{sing}}(X, D; \mathbb{Q})$ are countable. Hence, the image of the period pairing is also countable. There are only countably many isomorphism classes of pairs (X, D, j) , hence the set $\mathbb{P}^{\text{eff}}(k)$ is countable. \square

11.4 The comparison theorem

We introduce two more variants of period algebras. They are attached to subcategories of $(k, \mathbb{Q})\text{-Vect}$ by the method of Definition 11.2.1. Recall from Corollary 5.5.2 the functor

$$R\Gamma : K^-(\mathbb{Z}[\text{Sm}]) \rightarrow D_{(k, \mathbb{Q})}^+$$

and

$$H^i : K^-(\mathbb{Z}[\text{Sm}]) \rightarrow (k, \mathbb{Q})\text{-Vect}.$$

Definition 11.4.1.

- Let $\mathcal{C}(\text{Sm})$ be the full abelian subcategory of $(k, \mathbb{Q})\text{-Vect}$ closed under subquotients generated by $H^i(X_\bullet)$ for $X_\bullet \in K^-(\mathbb{Z}[\text{Sm}])$. Let $\mathbb{P}_{\text{Sm}}(k) = \mathbb{P}(\mathcal{C}(\text{Sm}))$ be the *algebra of periods of complexes of smooth varieties*.
- Let $\mathcal{C}(\text{SmAff})$ be the full abelian subcategory of $(k, \mathbb{Q})\text{-Vect}$ closed under subquotients and generated by $H^i(X_\bullet)$ for $X_\bullet \in K^-(\mathbb{Z}[\text{SmAff}])$ with SmAff the category of smooth affine varieties over k . Let $\mathbb{P}_{\text{SmAff}}(k) = \mathbb{P}(\mathcal{C}(\text{SmAff}))$ be the *algebra of periods of complexes of smooth affine varieties*.

Theorem 11.4.2. *Let $k \subset \mathbb{C}$ be a subfield. Then all definitions of period algebras given so far agree:*

$$\mathbb{P}_{\text{nc}}^{\text{eff}}(k) = \mathbb{P}^{\text{eff}}(k) = \mathbb{P}_{\text{Sm}}(k) = \mathbb{P}_{\text{SmAff}}(k)$$

and

$$\mathbb{P}_{\text{nc}}(k) = \mathbb{P}(k).$$

Remark 11.4.3. This is a simple corollary of Theorem 9.2.22 and Corollary 9.2.25 once we will have discussed the formal period algebra, see Corollary 13.1.10. However, the argument does not use the full force of Nori's machine, hence we give it directly. Note that the key input is the same as the key input for Nori's construction: the existence of good filtrations.

Proof. We are going to prove the identities on periods by showing that the subcategories of $(k, \mathbb{Q})\text{-Vect}$ appearing in their definitions are the same. More precisely, we are going to establish a sequence of inclusions of categories (to be defined below):

$$\mathcal{C}(\text{nc}) \subset \mathcal{C}(\text{Pairs}^{\text{eff}}) \subset \mathcal{C}(\text{Sm}) \subset \mathcal{C}(\text{SmAff}) \subset \mathcal{C}(\text{Pairs}^{\text{eff}}).$$

This already proves most of the equalities. Comparison with nc-periods will need an extra argument.

Let $\mathcal{C}(\text{Pairs}^{\text{eff}})$ be the full abelian subcategory closed under subquotients and generated by $H(X, D, j)$ for $(X, D) \in \text{Pairs}^{\text{eff}}$, i.e., X a variety and $D \subset X$ a closed subvariety. Furthermore, let $\mathcal{C}(\text{nc})$ be the full abelian subcategory closed under subquotients and generated by $H^d(X, D)$ with X smooth, affine of dimension d and D a divisor with normal crossings.

By definition

$$\mathcal{C}(\text{nc}) \subset \mathcal{C}(\text{Pairs}^{\text{eff}}).$$

By the construction in Definition 3.3.6, we may compute any $H(X, D, j)$ as $H^j(C_\bullet)$ with C_\bullet in $C^-(\mathbb{Z}[\text{Sm}])$. Actually, in any degree cohomology only depends on a bounded piece of C_\bullet . Hence

$$\mathcal{C}(\text{Pairs}^{\text{eff}}) \subset \mathcal{C}(\text{Sm}).$$

We next show that

$$\mathcal{C}(\text{Sm}) \subset \mathcal{C}(\text{SmAff}).$$

Let $X_\bullet \in C^-(\mathbb{Z}[\text{Sm}])$. By Lemma 9.2.11, there is a rigidified affine cover \tilde{U}_{X_\bullet} of X_\bullet . Let $C_\bullet = C_\bullet(\tilde{U}_{X_\bullet})$ be the total complex of the associated complex of Čech complexes (see Definition 9.2.12). By construction, $C_\bullet \in C^-(\mathbb{Z}[\text{SmAff}])$. By the Mayer–Vietoris property, we have

$$H(X_\bullet) = H(C_\bullet).$$

We claim that $\mathcal{C}(\text{SmAff}) \subset \mathcal{C}(\text{Pairs}^{\text{eff}})$. It suffices to consider bounded complexes because the cohomology of a bounded above complex of varieties only depends on a bounded quotient. Let X be smooth affine. Recall (see Proposition 9.2.3) that a very good filtration on X is a sequence of subvarieties

$$F_0X \subset F_1X \subset \cdots \subset F_nX = X$$

such that $F_jX \setminus F_{j-1}X$ is smooth, with F_jX of pure dimension j , or $F_jX = F_{j-1}X$ of dimension less than j and the cohomology of $(F_jX, F_{j-1}X)$ being concentrated in degree j . The boundary maps for the triples $F_{j-2}X \subset F_{j-1}X \subset F_jX$ define a complex $\tilde{R}(F_\bullet X)$ in $\mathcal{C}(\text{Pairs}^{\text{eff}})$

$$\cdots \rightarrow H^{j-1}(F_{j-1}X, F_{j-2}X) \rightarrow H^j(F_jX, F_{j-1}X) \rightarrow H^{j+1}(F_{j+1}X, F_jX) \rightarrow \cdots$$

whose cohomology agrees with $H^\bullet(X)$.

Let $X_\bullet \in C^b(\mathbb{Z}[\text{SmAff}])$. By Lemma 9.2.16, we can choose good filtrations on all X_n in a compatible way. The double complex $\tilde{R}(F_\bullet X)$ has the same cohomology as X_\bullet . By construction, it is a complex in $\mathcal{C}(\text{Pairs}^{\text{eff}})$, hence the cohomology is in $\mathcal{C}(\text{Pairs}^{\text{eff}})$.

Hence, we have now established that

$$\mathbb{P}_{\text{nc}}^{\text{eff}}(k) \subset \mathbb{P}^{\text{eff}}(k) = \mathbb{P}_{\text{Sm}}(k) = \mathbb{P}_{\text{SmAff}}(k).$$

We refine the argument in order to show that $\mathbb{P}_{\text{SmAff}}(k) \subset \mathbb{P}_{\text{nc}}(k)$. By the above computation, this will follow if periods of very good pairs are contained in $\mathbb{P}_{\text{nc}}(k)$. Let (X, Y, n) be a very good pair, in particular $X \setminus Y$ is smooth. By resolution of singularities, there is a proper birational map $X' \rightarrow X$ which is an isomorphism outside Y such that X' is smooth and the preimage Y' of Y is a divisor with normal crossings. By Jouanolou's trick, see [Jou73, Lemme 1.5], there is an \mathbb{A}^n -fibre bundle $X'' \rightarrow X'$ such that X'' is affine. As X' and \mathbb{A}^n are smooth, so is X'' . The preimage Y'' of Y' is still a divisor with normal crossings. By excision and homotopy invariance,

$$(k, \mathbb{Q})\text{-Vect}^n(X, Y) \cong (k, \mathbb{Q})\text{-Vect}^n(X', Y') \cong (k, \mathbb{Q})\text{-Vect}^n(X'', Y'').$$

By Proposition 3.3.19, every de Rham cohomology class in degree n is represented by a global differential form on X'' . Hence all cohomological periods of (X'', Y'', n) are normal crossing periods in the sense of Definition 11.1.1. \square

11.5 Periods of motives

Recall that we have introduced various categories of motives: the triangulated category of geometric motives DM_{gm} , see Section 6.2, the abelian category of Nori motives $\mathcal{M}\mathcal{M}_{\text{Nori}}$, see Section 9.1, and the abelian category of absolute Hodge motives, see Section 6.3. The latter have a natural forgetful functor to $(k, \mathbb{Q})\text{-Vect}$, introduced in Remark 6.3.4.

Recall the chain of tensor functors

$$DM_{\text{gm}} \rightarrow D^b(\mathcal{M}\mathcal{M}_{\text{Nori}}) \rightarrow D^b(\mathcal{M}\mathcal{M}_{\text{AH}}) \rightarrow D^b((k, \mathbb{Q})\text{-Vect})$$

constructed in Theorem 10.1.1 together with this forgetful functor.

- Definition 11.5.1.** 1. Let $\mathcal{C}(\text{gm})$ be the full subcategory of $(k, \mathbb{Q})\text{-Vect}$ closed under subquotients which is generated by $H(M)$ for $M \in DM_{\text{gm}}$. Let $\mathbb{P}_{\text{gm}} = \mathbb{P}(\mathcal{C}(\text{gm}))$ be the *period algebra of geometric motives*.
2. Let $\mathcal{C}(\text{Nori})$ be the full subcategory of $(k, \mathbb{Q})\text{-Vect}$ closed under subquotients which is generated by $H(M)$ for $M \in \mathcal{M}\mathcal{M}_{\text{Nori}}$. Let $\mathbb{P}_{\text{Nori}}(k) = \mathbb{P}(\mathcal{C}(\text{Nori}))$ be the *period algebra of Nori motives*.

3. Let $\mathcal{C}(\text{AH})$ be the full subcategory of $(k, \mathbb{Q})\text{-Vect}$ closed under subquotients which is generated by $\mathbf{H}(M)$ for $M \in \mathcal{MM}_{\text{AH}}$. Let $\mathbb{P}_{\text{AH}}(k) = \mathbb{P}(\mathcal{C}(\text{AH}))$ be the *period algebra of absolute Hodge motives*.

Remark 11.5.2. Note that $\mathcal{C}(\text{gm})$, $\mathcal{C}(\text{Nori})$ and $\mathcal{C}(\text{AH})$ are abelian tensor subcategories of $(k, \mathbb{Q})\text{-Vect}$. Hence, the period sets are indeed algebras.

Proposition 11.5.3. *We have*

$$\mathbb{P}(k) = \mathbb{P}_{\text{gm}}(k) = \mathbb{P}_{\text{Nori}}(k) = \mathbb{P}_{\text{AH}}(k).$$

Proof. From the functors between categories of motives, we have inclusions of subcategories of $(k, \mathbb{Q})\text{-Vect}$:

$$\mathcal{C}(\text{gm}) \subset \mathcal{C}(\text{Nori}) \subset \mathcal{C}(\text{AH}).$$

Moreover, the category $\mathcal{C}(\text{Sm}_k)$ of Definition 11.4.1 is contained in $\mathcal{C}(\text{gm})$. By definition, we also have $\mathcal{C}(\text{AH}) = \mathcal{C}(\text{Sm}_k)$. Hence, all categories are equal. Finally, recall that $\mathbb{P}(k) = \mathbb{P}(\text{Sm}_k)$ by Theorem 11.4.2. \square

Remark 11.5.4. The analogous statement for periods of effective motives is also true.

This allows us to easily translate information on motives into information on periods. Here is an example:

Corollary 11.5.5. *Let \mathcal{X} be an algebraic space, or, more generally, a Deligne–Mumford stack over k . Then the periods of \mathcal{X} are contained in $\mathbb{P}(k)$.*

Proof. Every Deligne–Mumford stack defines a geometric motive by the work of Choudhury [Cho12]. Their periods are therefore contained in the periods of geometric motives. \square

Chapter 12

Kontsevich–Zagier periods

This chapter follows closely the Diploma thesis of Benjamin Friedrich, see [Fri04]. The main results are due to him.

We are mostly interested in the cases $k = \mathbb{Q}$ and $k = \overline{\mathbb{Q}}$. Denote the integral closure of \mathbb{Q} in \mathbb{R} by $\tilde{\mathbb{Q}}$. Note that $\tilde{\mathbb{Q}}$ is a field.

12.1 Definition

Let $k \subset \mathbb{C}$ be a field. Recall the notion of a semi-algebraic set from Definition 2.6.1.

Definition 12.1.1 (Naive Periods after Friedrich [Fri04]). Let $k \subset \mathbb{C}$. Let

- $G \subset \mathbb{R}^n$ be an oriented compact $(k \cap \mathbb{R})$ -semi-algebraic set which is equidimensional of dimension d , and
- ω be a rational differential d -form on \mathbb{R}^n having coefficients in k , which does not have poles on G .

Then we call the complex number $\int_G \omega$ a *naive period* over k and denote the set of all effective naive periods for all G and ω by $\mathbb{P}_{\text{nv}}^{\text{eff}}(k)$. Let $\mathbb{P}_{\text{nv}}(k)$ be the set of quotients of naive periods by powers of $2\pi i$.

Examples of naive periods over $\overline{\mathbb{Q}}$ are

- $\int_1^2 \frac{dt}{t} = \log(2)$.
- $\int_{x^2+y^2 \leq 1} dx dy = \pi$.
- Elliptic integrals $\int_1^2 \frac{dt}{\sqrt{t^3+1}} = \int_G \frac{dt}{s}$, for

$$G := \{(t, s) \in \mathbb{R}^2 \mid 1 \leq t \leq 2, 0 \leq s, s^2 = t^3 + 1\}.$$

- The Cauchy integral $\int_{|z|=1} \frac{dz}{z} = 2\pi i$ (an imaginary number), a naive period for the field $k = \mathbb{Q}(i)$, since the circle is an algebraic subset and the differential form on \mathbb{R}^2 is given by

$$\frac{dz}{z} = \frac{x - iy}{x^2 + y^2} (dx + idy)$$

in standard coordinates $z = x + iy$.

Remark 12.1.2. Note that for a subset $G \subset \mathbb{R}^n$ being \mathbb{Q} -semi-algebraic is equivalent to being $\tilde{\mathbb{Q}}$ -semi-algebraic, see Proposition 2.6.5.

The definition was inspired by the one given in [KZ01, p. 772] for $k = \mathbb{Q}$:

Definition 12.1.3 (Kontsevich–Zagier). Let $k \subset \mathbb{R}$. A *Kontsevich–Zagier period* is a complex number whose real and imaginary parts are values of absolutely convergent integrals of rational functions with coefficients in k , over domains in \mathbb{R}^n given by polynomial inequalities with coefficients in k .

Let $\mathbb{P}_{\text{KZ}}^{\text{eff}}(k)$ be the set of Kontsevich–Zagier period numbers and $\mathbb{P}_{\text{KZ}}(k)$ the localisation of $\mathbb{P}_{\text{KZ}}^{\text{eff}}(k)$ with respect to $2\pi i$.

Remark 12.1.4. Kontsevich and Zagier also mention a variant of this definition where the rational function is replaced by an “algebraic function”, meaning a branch of an element of a finite field extension of the field of rational functions. See Remark 12.2.5 below for a comparison of both versions.

We will show in Section 12.2 that, at least for $k \subset \overline{\mathbb{Q}}$, Kontsevich–Zagier periods agree with naive periods in Definition 12.1.1, and indeed all other definitions of periods, see Theorem 12.2.1.

The set $\mathbb{P}_{\text{nv}}^{\text{eff}}(k)$ enjoys additional structure.

Proposition 12.1.5. *The set $\mathbb{P}_{\text{nv}}^{\text{eff}}(k)$ is a unital k -algebra.*

Proof. Multiplicative structure: In order to show that $\mathbb{P}_{\text{nv}}^{\text{eff}}(k)$ is closed under multiplication, we write

$$p_i : \mathbb{R}^{n_1} \times \mathbb{R}^{n_2} \longrightarrow \mathbb{R}^{n_i}, \quad i = 1, 2$$

for the natural projections and obtain

$$\left(\int_{G_1} \omega_1 \right) \cdot \left(\int_{G_2} \omega_2 \right) = \int_{G_1 \times G_2} p_1^* \omega_1 \wedge p_2^* \omega_2 \in \mathbb{P}_{\text{nv}}$$

by the Fubini formula.

Multiplication by k : Every $a \in k$ can be expressed as a naive period with $G = [0, 1] \subset \mathbb{R}$ with respect to the differential form adt . In particular, $1 \in \mathbb{P}_{\text{nv}}^{\text{eff}}(k)$.

Combining the last two steps, we can shift the dimension of the set G in the definition of a naive period number. Let $\alpha = \int_G \omega$. We represent 1 by $\int_{[0,1]} dt$ and hence also $\alpha = 1 \cdot \alpha = \int_{G \times [0,1]} \omega \wedge dt$.

Additive structure: Let $\int_{G_1} \omega_1$ and $\int_{G_2} \omega_2 \in \mathbb{P}_{\text{nv}}^{\text{eff}}(k)$ be periods with domains of integration $G_1 \subset \mathbb{R}^{n_1}$ and $G_2 \subset \mathbb{R}^{n_2}$. Using the dimension shift described above, we may assume without loss of generality that $\dim G_1 = \dim G_2$. Using the inclusions

$$\begin{aligned} i_1 : \mathbb{R}^{n_1} &\cong \mathbb{R}^{n_1} \times \{1/2\} \times \{0\} \subset \mathbb{R}^{n_1} \times \mathbb{R} \times \mathbb{R}^{n_2} \quad \text{and} \\ i_2 : \mathbb{R}^{n_2} &\cong \{0\} \times \{-1/2\} \times \mathbb{R}^{n_2} \subset \mathbb{R}^{n_1} \times \mathbb{R} \times \mathbb{R}^{n_2}, \end{aligned}$$

we can write $i_1(G_1) \cup i_2(G_2)$ for the disjoint union of G_1 and G_2 . With the projections $p_j : \mathbb{R}^{n_1} \times \mathbb{R} \times \mathbb{R}^{n_2} \rightarrow \mathbb{R}^{n_j}$ for $j = 1, 2$, we can lift ω_j on \mathbb{R}^{n_j} to $p_j^* \omega_j$ on $\mathbb{R}^{n_1} \times \mathbb{R} \times \mathbb{R}^{n_2}$. For $q_1, q_2 \in k$ we get

$$\begin{aligned} q_1 \int_{G_1} \omega_1 + q_2 \int_{G_2} \omega_2 \\ = \int_{i_1(G_1) \cup i_2(G_2)} q_1 \left(\frac{1}{2} + t \right) p_1^* \omega_1 + q_2 \left(\frac{1}{2} - t \right) p_2^* \omega_2 \in \mathbb{P}_{\text{nv}}(k), \end{aligned}$$

where t is the coordinate of the “middle” factor \mathbb{R} of $\mathbb{R}^{n_1} \times \mathbb{R} \times \mathbb{R}^{n_2}$. This shows that $\mathbb{P}_{\text{nv}}^{\text{eff}}(k)$ is a k -vector space. \square

Proposition 12.1.6. *The sets $\mathbb{P}_{\text{KZ}}^{\text{eff}}(\mathbb{Q})$ and $\mathbb{P}_{\text{KZ}}^{\text{eff}}(\tilde{\mathbb{Q}})$ are equal and form unital k -algebras. Moreover, a complex number is an effective KZ-period over \mathbb{Q} or $\tilde{\mathbb{Q}}$ if its real and imaginary part can be written as the difference of volumes of \mathbb{Q} -semi-algebraic subsets of \mathbb{R}^n (with finite volume).*

Proof. We start with the last assertion. Let $k = \mathbb{Q}$ or $k = \tilde{\mathbb{Q}}$. Let μ_n be the standard volume form on \mathbb{R}^n , $G \subset \mathbb{R}^n$ a k -semi-algebraic subset and f a rational function with coefficients in k . By definition, $\int_G f \mu_n$ is a real effective KZ-period over k . Let G^+ and G^- be the subsets of G on which f is semi-positive and semi-negative, respectively. They are also semi-algebraic. Consider the semi-algebraic sets

$$\begin{aligned} \Gamma^+ &= \{(x, t) \in \mathbb{R}^n \times \mathbb{R} \mid x \in G^+, 0 \leq t \leq f(x)\}, \\ \Gamma^- &= \{(x, t) \in \mathbb{R}^n \times \mathbb{R} \mid x \in G^-, f(x) \leq t \leq 0\}. \end{aligned}$$

Then

$$\text{vol}(\Gamma^\pm) = \int_{\Gamma^\pm} \mu_{n+1} = \pm \int_{G^\pm} f \mu_n$$

and hence

$$\int_G f \mu_n = \text{vol}(\Gamma^+) - \text{vol}(\Gamma^-).$$

Both integrals converge because the original integral converges absolutely. By Proposition 2.6.5, a subset of \mathbb{R}^n is \mathbb{Q} -semi-algebraic if and only if it is $\tilde{\mathbb{Q}}$ -semi-algebraic. This already implies that $\mathbb{P}_{\text{KZ}}^{\text{eff}}(\mathbb{Q}) = \mathbb{P}_{\text{KZ}}^{\text{eff}}(\tilde{\mathbb{Q}})$.

For the algebra structure, the same arguments as for naive periods can be used, except for addition. By the reduction to the special shape, we only need to add and subtract volumina. Let $G_1, G_2 \subset \mathbb{R}^n$ be $\tilde{\mathbb{Q}}$ -semi-algebraic. Then

$$\text{vol}(G_1) + \text{vol}(G_2) = \text{vol}(G_1 \times [0, 1] \cup G_2 \times [2, 3])$$

and

$$\text{vol}(G_1) - \text{vol}(G_2) = \int_G x_{n+1} \mu_{n+1}$$

with x_{n+1} the last coordinate of \mathbb{R}^{n+1} and

$$G = G_1 \times [0, \sqrt{2}] \cup G_2 \times [-\sqrt{3}, -1]$$

because

$$\begin{aligned} \int_0^{\sqrt{2}} x_{n+1} dx_{n+1} &= \frac{\sqrt{2}^2}{2} = 1, \\ \int_{-\sqrt{3}}^{-1} x_{n+1} dx_{n+1} &= \frac{(-1)^2}{2} - \frac{(-\sqrt{3})^2}{2} = -1. \end{aligned}$$

Putting these formulas together, the sum of two effective KZ-periods over $\tilde{\mathbb{Q}}$ is again a KZ-period over $\tilde{\mathbb{Q}}$. \square

The following example gives the representation of a very interesting number as a Kontsevich–Zagier period over \mathbb{Q} in the sense of Definition 12.1.3. A priori, it is not a naive period.

Proposition 12.1.7. *We have*

$$\int_{0 \leq t_1 \leq t_2 \leq 1} \frac{dt_1 \wedge dt_2}{(1-t_1)t_2} = \zeta(2). \quad (12.1)$$

Proof. This equality follows by a simple power series manipulation. For $0 \leq t_2 < 1$, we have

$$\int_0^{t_2} \frac{dt_1}{1-t_1} = -\log(1-t_2) = \sum_{n=1}^{\infty} \frac{t_2^n}{n}.$$

Let $\epsilon > 0$. The power series $\sum_{n=1}^{\infty} \frac{t_2^{n-1}}{n}$ converges uniformly for $0 \leq t_2 \leq 1-\epsilon$ and we get

$$\int_{0 \leq t_1 \leq t_2 \leq 1-\epsilon} \frac{dt_1 dt_2}{(1-t_1)t_2} = \int_0^{1-\epsilon} \sum_{n=1}^{\infty} \frac{t_2^{n-1}}{n} dt_2 = \sum_{n=1}^{\infty} \frac{(1-\epsilon)^n}{n^2}.$$

Applying Abel's Theorem [Fic90, p. 411] and using $\sum_{n=1}^{\infty} \frac{1}{n^2} < \infty$ gives us

$$\int_{0 \leq t_1 \leq t_2 \leq 1} \frac{dt_1 dt_2}{(1-t_1)t_2} = \lim_{\epsilon \rightarrow 0} \sum_{n=1}^{\infty} \frac{(1-\epsilon)^n}{n^2} \stackrel{(*)}{=} \sum_{n=1}^{\infty} \frac{1}{n^2} = \zeta(2).$$

□

Equation (12.1) is not a valid representation of $\zeta(2)$ as an integral for a naive period, because the pole locus $\{t_1 = 1\} \cup \{t_2 = 0\}$ of $\frac{dt_1 \wedge dt_2}{(1-t_1)t_2}$ is not disjoint with the domain of integration $\{0 \leq t_1 \leq t_2 \leq 1\}$. As mentioned before, (12.1) does give a valid period integral according to the original definition of Kontsevich–Zagier — see Definition 12.1.3. We will show in Example 15.1 how to directly circumvent this difficulty by a blow-up. The general blow-up procedure which makes this possible is used in the proof of Lemma 12.2.4. This argument shows that Kontsevich–Zagier periods and naive periods are the same.

12.2 Comparison of definitions of periods

We now concentrate on the cases $k = \mathbb{Q}$ and $k = \overline{\mathbb{Q}}$. One has the following equalities among periods:

Theorem 12.2.1.

$$\mathbb{P}^{\text{eff}}(\mathbb{Q}) = \mathbb{P}_{\text{nc}}^{\text{eff}}(\mathbb{Q}) = \mathbb{P}_{\text{nc}}^{\text{eff}}(\overline{\mathbb{Q}}) = \mathbb{P}_{\text{nv}}^{\text{eff}}(\mathbb{Q}) = \mathbb{P}_{\text{nv}}^{\text{eff}}(\overline{\mathbb{Q}}) = \mathbb{P}_{\text{KZ}}^{\text{eff}}(\mathbb{Q}) = \mathbb{P}_{\text{KZ}}^{\text{eff}}(\tilde{\mathbb{Q}})$$

and

$$\mathbb{P}(\mathbb{Q}) = \mathbb{P}_{\text{nc}}(\mathbb{Q}) = \mathbb{P}_{\text{nc}}(\overline{\mathbb{Q}}) = \mathbb{P}_{\text{nv}}(\mathbb{Q}) = \mathbb{P}_{\text{nv}}(\overline{\mathbb{Q}}) = \mathbb{P}_{\text{KZ}}(\mathbb{Q}) = \mathbb{P}_{\text{KZ}}(\tilde{\mathbb{Q}}).$$

Moreover, a complex number is an effective period number over $\overline{\mathbb{Q}}$ if and only if its real and imaginary parts can be written as differences of volumes of \mathbb{Q} -semi-algebraic subsets of dimension n in \mathbb{R}^n with respect to the standard volume form on \mathbb{R}^n for some n .

The proof will take the rest of this section.

Lemma 12.2.2. *We have an inclusion*

$$\mathbb{P}_{\text{nv}}^{\text{eff}}(\overline{\mathbb{Q}}) \hookrightarrow \mathbb{P}_{\text{KZ}}^{\text{eff}}(\tilde{\mathbb{Q}}).$$

Proof. Let $\int_G \omega \in \mathbb{P}_{\text{nv}}^{\text{eff}}(\overline{\mathbb{Q}})$. By decomposing ω into its real and imaginary parts, it suffices to consider differential forms ω with coefficients in $\tilde{\mathbb{Q}}$. Hence it suffices to prove the inclusion $\mathbb{P}_{\text{nv}}^{\text{eff}}(\tilde{\mathbb{Q}}) \subset \mathbb{P}_{\text{KZ}}^{\text{eff}}(\tilde{\mathbb{Q}})$.

Let (G, ω) be as in the definition of a naive period over $\tilde{\mathbb{Q}}$, i.e., $G \subset \mathbb{R}^n$ an oriented compact $\tilde{\mathbb{Q}}$ -semi-algebraic set, equidimensional of dimension $d \leq n$ and ω a rational differential d -form on \mathbb{R}^n having coefficients in $\tilde{\mathbb{Q}}$ and without poles on G .

We are repeatedly going to subdivide G into finitely many $\tilde{\mathbb{Q}}$ -semi-algebraic subsets. By linearity it suffices to prove the assertion for the individual pieces. Hence we may replace G by the closure (in the analytic topology) of one of the pieces.

Let Y be the Zariski closure of G . It is defined over $\tilde{\mathbb{Q}}$. By decomposing Y into its irreducible components and G into the intersection with these components, we may assume that Y is irreducible.

By Noether normalisation, there is a finite surjective morphism $p : Y \rightarrow \mathbb{A}_{\tilde{\mathbb{Q}}}^d$. We write $p_{\mathbb{R}}$ for the associated analytic map on \mathbb{R} -points. We claim:

Sublemma: There is a semi-algebraic triangulation of G such that $p_{\mathbb{R}}$ is injective and unramified on the interior of simplices of dimension d .

To prove the sublemma, let Y^0 be the ramification locus of p . It is again defined over $\tilde{\mathbb{Q}}$. On $Y \setminus Y^0$, the map p is unramified and hence a local homeomorphism in the analytic topology.

We apply Proposition 2.6.10 to the system $\{p(G), p(G \cap Y^0(\mathbb{R}))\}$ and obtain an adapted triangulation of \mathbb{R}^d into open $\tilde{\mathbb{Q}}$ -semi-algebraic simplices. Let $\Delta_1, \dots, \Delta_M$ be the finitely many simplices covering the image of G . Note that each Δ_i is either fully contained in $p(Y^0(\mathbb{R}))$ or disjoint from it. In particular, p is unramified above the Δ_i of dimension d . Moreover, such a Δ_i is simply connected in the analytic topology. Hence, $p_{\mathbb{R}}^{-1}(\Delta_i) \subset Y(\mathbb{R})$ decomposes into finitely many copies of Δ_i on which $p_{\mathbb{R}}$ is injective and unramified.

We now apply Proposition 2.6.10 to the system $\{G \cap p_{\mathbb{R}}^{-1}(\Delta_i) \mid i = 1, \dots, M\}$ in \mathbb{R}^n . This yields finitely many open $\tilde{\mathbb{Q}}$ -semi-algebraic simplices G_1, \dots, G_N covering G .

Let G_j be one such simplex of dimension d . It is connected and contained in $p_{\mathbb{R}}^{-1}(\Delta_i)$ for some index i such that Δ_i has dimension d . Hence it is fully contained in one of the copies of Δ_i in $Y(\mathbb{R})$. This implies that $p_{\mathbb{R}}|_{G_j}$ is injective and unramified, as claimed.

This finishes the proof of the sublemma.

We now replace G by the analytic closure of G_j . Hence we may assume that there is a finite surjective algebraic map $Y \rightarrow \mathbb{A}^d$ which is injective and unramified in the interior of G . Let $G' \subset \mathbb{R}^d$ be its image.

We have two rational differential forms with coefficients in $\tilde{\mathbb{Q}}$ on Y : on the one hand $\omega|_Y$, on the other hand $p^*\mu_d$ where μ_d is the standard volume form on $\mathbb{A}_{\tilde{\mathbb{Q}}}^d$. As Y is irreducible, the space of rational differential forms on Y is a one-dimensional vector space over the function field $\tilde{\mathbb{Q}}(Y)$ of Y . The form $p^*\mu_d$ is a volume form on the interior of G because p is unramified there. In particular, it is non-zero. Hence there is an $f \in \tilde{\mathbb{Q}}(Y)$ such that

$$\omega|_Y = fp^*\mu_d.$$

Both forms are regular on G . Moreover, $p^*\mu_d$ is a volume form on the interior of g because p is unramified there. This implies that f is regular on the interior of G . By subdividing G further into semi-algebraic regions where f is semi-positive or semi-negative, and therefore, taking linear combinations of integrals, we may assume that f is semi-positive on G .

Consider the (in general non-compact) \mathbb{Q} -semi-algebraic region $\Gamma \subset G \times \mathbb{R}$ below the graph of f . We have

$$\int_{\Gamma} p^*\mu_d \wedge dt = \int_G f p^*\mu_d = \int_G \omega.$$

In particular, the integral converges absolutely. The image $\Gamma' \subset G' \times \mathbb{R} \subset \mathbb{R}^{d+1}$ is also \mathbb{Q} -semi-algebraic and

$$\int_{\Gamma} p^*\mu_d \wedge dt = \int_{\Gamma'} (p \times \text{id})^*\mu_{d+1} = \int_{\Gamma'} \mu_{d+1}.$$

We have found a representation of $\int_G \omega$ as an absolutely convergent integral over a \mathbb{Q} -semi-algebraic domain in \mathbb{R}^{d+1} , i.e., as a KZ-period. \square

Lemma 12.2.3 (Friedrich [Fri04]).

$$\mathbb{P}_{\text{nc}}^{\text{eff}}(\mathbb{Q}) \subset \mathbb{P}_{\text{nv}}^{\text{eff}}(\mathbb{Q}).$$

Proof. By definition, the elements of $\mathbb{P}_{\text{nc}}^{\text{eff}}(\mathbb{Q})$ are of the form $\int_{\gamma} \omega$ where $\gamma \in H_d^{\text{sing}}(X^{\text{an}}, D^{\text{an}}; \mathbb{Q})$ with X a smooth variety of dimension d over \mathbb{Q} , D a divisor with normal crossings and $\omega \in \Gamma(X, \Omega_X^d)$.

We choose an embedding

$$X \subset \mathbb{P}_{\mathbb{Q}}^n$$

and equip $\mathbb{P}_{\mathbb{Q}}^n$ with coordinates $[x_0 : \dots : x_n]$. Lemma 2.6.6 provides us with a map

$$\psi : \mathbb{P}_{\mathbb{C}}^n \hookrightarrow \mathbb{R}^N$$

such that D^{an} and $\mathbb{P}_{\mathbb{C}}^n$ become \mathbb{Q} -semi-algebraic subsets of \mathbb{R}^N . Then, by Proposition 2.6.9, the homology class $\psi_*\gamma$ has a representative which is a rational linear combination of singular simplices Γ_i , each of which is \mathbb{Q} -semi-algebraic. By Proposition 2.6.5 this makes them even \mathbb{Q} -semi-algebraic.

As $\mathbb{P}_{\text{nv}}^{\text{eff}}(\mathbb{Q})$ is a \mathbb{Q} -algebra by Proposition 12.1.5, it suffices to prove that

$$\int_{\psi^{-1}(\text{Im}\Gamma_i)} \omega \in \mathbb{P}_{\text{nv}}^{\text{eff}}(\mathbb{Q}).$$

We drop the index i from now. Set $G = \text{Im}\Gamma$. The claim will be clear as soon as we find a rational differential form ω' on \mathbb{R}^N such that $\psi^*\omega' = \omega$, since then

$$\int_{\psi^{-1}(G)} \omega = \int_{\psi^{-1}(G)} \psi^*\omega' = \int_G \omega' \in \mathbb{P}_{\text{nv}}^{\text{eff}}(\mathbb{Q}).$$

After applying a barycentric subdivision to Γ , if necessary, we may assume without loss of generality that there exists a hyperplane in $\mathbb{P}_{\mathbb{C}}^n$, say $\{x_0 = 0\}$, which does not meet $\psi^{-1}(G)$. Furthermore, we may assume that $\psi^{-1}(G)$ lies entirely in U^{an} for U an open affine subset of $D \cap \{x_0 \neq 0\}$. (As before, U^{an} denotes the complex analytic space associated to the base change to \mathbb{C} of U .) The restriction of ω to the open affine subset can be represented in the form (see [Har77, II.8.4A, II.8.2.1, II.8.2A])

$$\sum_{|J|=d} f_J(x_0, \dots, x_n) d\left(\frac{x_{j_1}}{x_0}\right) \wedge \dots \wedge d\left(\frac{x_{j_d}}{x_0}\right)$$

where $f_J(x_0, \dots, x_n) \in \mathbb{Q}(x_0, \dots, x_n)$ is homogenous of degree zero. This expression defines a rational differential form on all of $\mathbb{P}_{\mathbb{Q}}^n$ with coefficients in \mathbb{Q} and it does not have poles on $\psi^{-1}(G)$.

We construct the rational differential form ω' on \mathbb{R}^N with coefficients in $\mathbb{Q}(i)$ as follows

$$\omega' := \sum_{|J|=d} f_J\left(1, \frac{y_{10} + iz_{10}}{y_{00} + iz_{00}}, \dots, \frac{y_{n0} + iz_{n0}}{y_{00} + iz_{00}}\right) d\left(\frac{y_{j_1 0} + iz_{j_1 0}}{y_{00} + iz_{00}}\right) \wedge \dots \wedge d\left(\frac{y_{j_d 0} + iz_{j_d 0}}{y_{00} + iz_{00}}\right),$$

where we have used the notation from the proof of Lemma 2.6.6. Using the explicit form of ψ given in this proof, we obtain

$$\begin{aligned} \psi^* f_J\left(1, \frac{y_{10} + iz_{10}}{y_{00} + iz_{00}}, \dots, \frac{y_{n0} + iz_{n0}}{y_{00} + iz_{00}}\right) &= f_J\left(\frac{x_0 \bar{x}_0}{|x_0|^2}, \frac{x_1 \bar{x}_0}{|x_0|^2}, \dots, \frac{x_n \bar{x}_0}{|x_0|^2}\right) \\ &= f_J(x_0, x_1, \dots, x_n) \end{aligned}$$

and

$$\psi^* d\left(\frac{y_{j0} + iz_{j0}}{y_{00} + iz_{00}}\right) = d\left(\frac{x_j \bar{x}_0}{|x_0|^2}\right) = d\left(\frac{x_j}{x_0}\right).$$

This shows that $\psi^* \omega' = \omega$. This is nearly what we wanted as ω' still has coefficients in $\mathbb{Q}(i)$. We decompose ω' into its real and imaginary parts and we are done. \square

The next inclusion combines a result of Friedrich in [Fri04] for naive periods with an argument of Belkale and Brosnan [BB03, Prop. 4.2].

Lemma 12.2.4.

$$\mathbb{P}_{\text{KZ}}^{\text{eff}}(\tilde{\mathbb{Q}}) \subset \mathbb{P}_{\text{nc}}^{\text{eff}}(\overline{\mathbb{Q}}).$$

Proof. We will use objects over various base fields. We will use subscripts to indicate which base field is used: a subscript 0 for $\tilde{\mathbb{Q}}$, a subscript 1 for $\overline{\mathbb{Q}}$, a subscript \mathbb{R} for \mathbb{R} and \mathbb{C} for \mathbb{C} . The associated complex analytic space

will be indicated by a superscript \cdot^{an} as before. Recall that we have fixed an embedding $\tilde{\mathbb{Q}} \subset \mathbb{C}$.

Set-up: Let $\int_G \omega_{\mathbb{R}} \in \mathbb{P}_{\text{KZ}}^{\text{eff}}(\tilde{\mathbb{Q}})$ be a period with

- $G \subset \mathbb{R}^n$ an oriented $\tilde{\mathbb{Q}}$ -semi-algebraic set defined by polynomial inequalities $h_i \geq 0$ of dimension n , and
- ω_0 a rational differential n -form on \mathbb{A}^n with coefficients in $\tilde{\mathbb{Q}}$, and
- $\omega_{\mathbb{R}}$ and $\omega_{\mathbb{C}}$ the induced forms on \mathbb{R}^n and \mathbb{C}^n , respectively,

such that the integral converges absolutely.

We extend ω_0 to a rational differential form on $\mathbb{P}_{\tilde{\mathbb{Q}}}^n$ (also denoted by ω_0) by adding a homogenous variable. The closure $\tilde{G} \subset \mathbb{P}^n(\mathbb{R})$ is a *compact* semi-algebraic domain.

As the dimension of G is n , the Zariski closure of \tilde{G} in $\mathbb{P}_{\mathbb{R}}^n$ is actually all of $\mathbb{P}_{\mathbb{R}}^n$.

The boundary ∂G of \tilde{G} is supported on an algebraic variety. As $\dim G = n$, the variety $V(H)$ for $H = \prod h_i$ does the job. Let $E_0 \subset \mathbb{P}_{\tilde{\mathbb{Q}}}^n$ be a divisor containing $V(H)$ and the pole locus of ω_0 . In order to obtain an nc-period, we need smooth varieties. Moreover, we need the differential form to be holomorphic on the domain of integration.

Step 1: We use Hironaka’s resolution of singularities. Following [BB03] we apply [Hir64, Main Theorem II]. This provides us with a cartesian square

$$\begin{array}{ccc} \tilde{E}_0 \subset \tilde{Y}_0 & & \\ \downarrow & \downarrow \pi_0 & \\ E_0 \subset \mathbb{P}_{\tilde{\mathbb{Q}}}^n & & \end{array} \tag{12.2}$$

such that

- \tilde{Y}_0 is smooth and projective;
- π_0 is proper, surjective and birational, and an isomorphism away from \tilde{E}_0 ;
- \tilde{E}_0 is a divisor with normal crossings;
- near each complex point $P \in \tilde{E}_0^{\text{an}}$ there are local holomorphic coordinates x_1, \dots, x_n on \tilde{Y}_0^{an} , a unit in $\mathcal{O}_{\tilde{Y}_0^{\text{an}}, P}$ and integers f_j for each $j = 1, \dots, n$, such that

$$\pi^* \omega_{\mathbb{C}} = \text{unit} \times \prod_{j=1}^n x_j^{f_j} dx_1 \wedge \dots \wedge dx_n.$$

We consider the “strict transform” of \tilde{G}

$$\tilde{G} := \overline{\pi_{\text{an}}^{-1}(G \setminus E^{\text{an}})} \subset \tilde{Y}_{\mathbb{R}}(\mathbb{R}).$$

It is compact since it is a closed subset of the compact set $\pi_{\mathbb{R}}^{-1}(\tilde{G})$. As G, \tilde{G} and \tilde{G} only differ by a set of measure zero, we have

$$\int_G \omega_{\mathbb{R}} = \int_{\tilde{G}} \omega_{\mathbb{R}} = \int_{\tilde{G}} \tilde{\omega}_{\mathbb{R}}$$

with $\tilde{\omega}_0 = \pi_0^* \omega_0$ and $\tilde{\omega}_{\mathbb{R}} = \pi_{\mathbb{R}}^* \omega_{\mathbb{R}}$. It suffices to show that the latter is an nc-period.

Step 2: Our next aim is to define suitable varieties on which the differential form is regular. We first make a base change in (12.2) from $\tilde{\mathbb{Q}}$ to $\overline{\mathbb{Q}}$ and obtain

$$\begin{array}{ccc} \tilde{E}_1 & \subset & \tilde{Y}_1 \\ \downarrow & & \downarrow \pi_1 \\ E_1 & \subset & \mathbb{P}_{\overline{\mathbb{Q}}}^n. \end{array}$$

The original differential n -form ω_0 on $\mathbb{A}_{\overline{\mathbb{Q}}}^n$ can be written as

$$\omega_0 = f(x_1, \dots, x_n) dx_1 \wedge \dots \wedge dx_n, \tag{12.3}$$

where x_1, \dots, x_n are coordinates of $\mathbb{A}_{\overline{\mathbb{Q}}}^n$ and $f \in \tilde{\mathbb{Q}}(x_1, \dots, x_n)$. The same formula also defines a differential form ω_1 on $\mathbb{A}_{\overline{\mathbb{Q}}}^n$ and $\omega_{\mathbb{R}}$ on \mathbb{R}^n . Let

$$\tilde{\omega}_1 := \pi_1^*(\omega_1).$$

Let $Z_1 \subset \mathbb{P}_{\overline{\mathbb{Q}}}^n$ and $\tilde{Z}_1 \subset \tilde{Y}_1$ be their pole loci, respectively. Recall that $Z_1 \subset E_1$ and hence $\tilde{Z}_1 \subset \tilde{E}_1$.

We set

$$\begin{aligned} X_1 &:= \mathbb{P}_{\overline{\mathbb{Q}}}^n \setminus Z_1, & D_1 &= E_1 \setminus Z_1, \\ \tilde{X}_1 &:= \tilde{Y}_1 \setminus \tilde{Z}_1, & \tilde{D}_1 &:= \tilde{E}_1 \setminus \tilde{Z}_1. \end{aligned}$$

The restriction $\omega_1|_{X_1}$ is a regular algebraic differential form on X_1 ; the pullback $\tilde{\omega}_1$ is a regular algebraic differential form on \tilde{X}_1 .

Recall the special shape of \tilde{Y} that we arranged in (12.2), in particular the description of $\pi_{\mathbb{R}}^* \omega_{\mathbb{R}}$ in holomorphic coordinates. It is regular at points of \tilde{G} in the complement of \tilde{E}^{an} . Consider $P \in \tilde{G} \cap \tilde{E}^{\text{an}}$. The absolute convergence of $\int_G \omega_{\mathbb{R}}$ implies the local convergence of $\tilde{\omega}_{\mathbb{R}}$ over regions $\{0 < x_i < \epsilon\}$ at each point $P \in \tilde{G}$. This is only possible if all $f_j \geq 0$. Therefore, $\pi_{\mathbb{R}}^* \omega_{\mathbb{R}}$ is holomorphic at the point P , and hence on the whole of \tilde{G} . Hence $\tilde{G} \subset \tilde{X}_1^{\text{an}}$.

Step 3: We now want to show that \tilde{G} can be triangulated. We choose an embedding

$$\tilde{Y}^{\text{an}} \subset \mathbb{P}_{\mathbb{C}}^m$$

for some $m \in \mathbb{N}$. Using Lemma 2.6.6, we may consider both $\mathbb{P}_{\mathbb{C}}^n$ and \tilde{Y}^{an} as $\tilde{\mathbb{Q}}$ -semi-algebraic sets via some maps

$$\begin{aligned} \psi &: \mathbb{P}^n(\mathbb{C})^{\text{an}} \hookrightarrow \mathbb{R}^N, \quad \text{and} \\ \tilde{\psi} &: \tilde{Y}^{\text{an}} \subset \mathbb{P}^m(\mathbb{C})^{\text{an}} \hookrightarrow \mathbb{R}^M. \end{aligned}$$

In this setting, the induced projection

$$\pi_{\text{an}} : \tilde{Y}^{\text{an}} \longrightarrow \mathbb{P}^n(\mathbb{C})^{\text{an}}$$

becomes a $\tilde{\mathbb{Q}}$ -semi-algebraic map. The subset $\tilde{G} \subset \mathbb{P}^n(\mathbb{C})^{\text{an}} \subset \mathbb{R}^N$ is $\tilde{\mathbb{Q}}$ -semi-algebraic by Fact 2.6.4. Since E^{an} is also $\tilde{\mathbb{Q}}$ -semi-algebraic via ψ , we find that $\tilde{G} \setminus E^{\text{an}}$ is $\tilde{\mathbb{Q}}$ -semi-algebraic. Again by Fact 2.6.4, $\pi_{\text{an}}^{-1}(\tilde{G} \setminus E^{\text{an}}) \subset \mathbb{R}^M$ is $\tilde{\mathbb{Q}}$ -semi-algebraic. Thus $\tilde{G} \subset \mathbb{R}^M$, being the closure of a $\tilde{\mathbb{Q}}$ -semi-algebraic set, is $\tilde{\mathbb{Q}}$ -semi-algebraic. From Proposition 2.6.10, we see that \tilde{G} can be triangulated

$$\tilde{G} = \bigcup_j \Delta_j, \tag{12.4}$$

where the Δ_j are (homeomorphic images of) n -dimensional simplices.

Since G is oriented, so is $\pi_{\text{an}}^{-1}(G \setminus E^{\text{an}})$, because π_{an} is an isomorphism away from E^{an} . Every n -simplex Δ_j in (12.4) intersects $\pi_{\text{an}}^{-1}(G \setminus E^{\text{an}})$ in a dense open subset, hence inherits an orientation. As in the proof of Proposition 2.6.9, we choose orientation-preserving homeomorphisms from the standard n -simplex Δ_n^{std} to Δ_j

$$\sigma_j : \Delta_n^{\text{std}} \longrightarrow \Delta_j.$$

These maps sum up to a singular chain

$$\tilde{\Gamma} = \sum_j \sigma_j \in \mathbb{C}_n^{\text{sing}}(\tilde{X}^{\text{an}}; \mathbb{Q}).$$

It might happen that the boundary of the singular chain $\tilde{\Gamma}$ is not supported on $\partial\tilde{G}$. Nevertheless, it will always be supported on \tilde{D}^{an} : The set $\pi_{\text{an}}^{-1}(G \setminus E^{\text{an}})$ is oriented and therefore the boundary components of $\partial\Delta_j$ that do not belong to $\partial\tilde{G}$ cancel if they have non-zero intersection with $\pi_{\text{an}}^{-1}(G \setminus E^{\text{an}})$. Thus $\tilde{\Gamma}$ gives rise to a singular homology class

$$\tilde{\gamma} \in H_n^{\text{sing}}(\tilde{X}^{\text{an}}, \tilde{D}^{\text{an}}; \mathbb{Q}).$$

Conclusion: We denote the base change to \mathbb{C} of ω_1 and $\tilde{\omega}_1$ by $\omega_{\mathbb{C}}$ and $\tilde{\omega}_{\mathbb{C}}$, respectively. Now

$$\int_G \omega_{\mathbb{R}} = \int_{\tilde{G}} \pi^* \omega_{\mathbb{R}} = \int_{\tilde{G}} \tilde{\omega}_{\mathbb{R}} = \int_{\tilde{G}} \tilde{\omega}_{\mathbb{C}} = \int_{\tilde{\Gamma}} \tilde{\omega}_{\mathbb{C}} = \int_{\tilde{\gamma}} \tilde{\omega}_{\mathbb{C}} \in \mathbb{P}_{\text{nc}}^{\text{eff}}(\overline{\mathbb{Q}})$$

is a period for the quadruple $(\tilde{X}_1, \tilde{D}_1, \tilde{\omega}_1, \tilde{\gamma})$. □

Remark 12.2.5. The same argument shows that the more general KZ-periods with “algebraic” integrands (see Remark 12.1.4) are nc-periods. Indeed, in this case we are actually integrating a rational differential form on

a branched cover $C_0 \rightarrow \mathbb{A}_{\mathbb{Q}}^n$ over a semi-algebraic set $G \subset C(\mathbb{R})$ defined over $\tilde{\mathbb{Q}}$. Let $Y_{\mathbb{R}}$ be the Zariski closure of G in C . The proof continues from here by replacing $\mathbb{P}_{\mathbb{R}}^n$ with $Y_{\mathbb{R}}$. Combining this fact with the other lemmas as in the proof of Theorem 12.2.1 below, this implies that this notion also agrees with all the others.

Proof of Theorem 12.2.1. By combining Lemma 12.2.2, the obvious inclusion for $\mathbb{Q} \subset \overline{\mathbb{Q}}$, Lemma 12.2.3 and Lemma 12.2.4, we have shown that there is a sequence of inclusions

$$\begin{array}{ccccccc} \mathbb{P}_{\text{nc}}^{\text{eff}}(\mathbb{Q}) & \hookrightarrow & \mathbb{P}_{\text{nv}}^{\text{eff}}(\mathbb{Q}) & \hookrightarrow & \mathbb{P}_{\text{nv}}^{\text{eff}}(\overline{\mathbb{Q}}) & \hookrightarrow & \mathbb{P}_{\text{KZ}}(\tilde{\mathbb{Q}}) \hookrightarrow \mathbb{P}_{\text{nc}}^{\text{eff}}(\overline{\mathbb{Q}}). \\ & & & & & & \parallel \\ & & & & & & \mathbb{P}_{\text{KZ}}^{\text{eff}}(\mathbb{Q}) \end{array}$$

By Proposition 11.1.7, these are even equalities. By Theorem 11.4.2, we finally have $\mathbb{P}^{\text{eff}}(\mathbb{Q}) = \mathbb{P}_{\text{nc}}^{\text{eff}}(\mathbb{Q})$. The reduction to volumes of \mathbb{Q} -semi-algebraic sets is contained in Proposition 12.1.6. \square

Remark 12.2.6. The reduction from $\tilde{\mathbb{Q}}$ -semi-algebraic sets to \mathbb{Q} -semi-algebraic sets is also a direct consequence of Proposition 2.6.5. On an elementary level, the use of the minimal polynomial f in its proof shows directly that real algebraic numbers u are periods: Choose $a, b \in \mathbb{Q}$ with $a < u < b$ and u the only root of its minimal polynomial between a and b . Assume also without loss of generality that $f'(u) > 0$. Then the integral

$$\int_G dx = b - u$$

is a period, where $G := \{x \in \mathbb{R} \mid a \leq x \leq b, f(x) \geq 0\}$. Hence u is a period.

The reader should revisit the above proofs in the case of the example of the nc-period $2\pi i$ with $(X, D, \omega, \gamma) = (\mathbb{G}_m, \{1\}, \frac{dz}{z}, S^1)$.

Chapter 13

Formal periods and the period conjecture

Following Kontsevich (see [Kon99]), we now introduce another algebra $\tilde{\mathbb{P}}(k)$ of *formal periods* from the same data we have used in order to define the actual period algebra of a field in Chapter 11. It comes with an obvious surjective map to $\mathbb{P}(k)$.

The first aim of the chapter is to give a conceptual interpretation of $\tilde{\mathbb{P}}(k)$ as the ring of algebraic functions on the torsor between two fibre functors on Nori motives: singular cohomology and algebraic de Rham cohomology.

We then discuss the period conjecture from this point of view.

13.1 Formal periods and Nori motives

Definition 13.1.1 (Formal Periods). Let $k \subset \mathbb{C}$ be a subfield. The space of *effective formal periods* $\tilde{\mathbb{P}}^{\text{eff}}(k)$ is defined as the \mathbb{Q} -vector space generated by symbols (X, D, ω, γ) , where X is an algebraic variety over k , $D \subset X$ a subvariety, $\omega \in H_{\text{dR}}^d(X, D)$ and $\gamma \in H_d(X(\mathbb{C}), D(\mathbb{C}), \mathbb{Q})$ with relations

1. linearity in ω and γ ;
2. for every $f : X \rightarrow X'$ with $f(D) \subset D'$

$$(X, D, f^*\omega', \gamma) = (X', D', \omega', f_*\gamma);$$

3. for every triple $Z \subset Y \subset X$

$$(Y, Z, \omega, \partial\gamma) = (X, Y, \delta\omega, \gamma),$$

with ∂ the connecting morphism for relative singular homology and δ the connecting morphism for relative de Rham cohomology.

We write $[X, D, \omega, \gamma]$ for the image of the generator. The vector space $\tilde{\mathbb{P}}^{\text{eff}}(k)$ is turned into an algebra via

$$[X, D, \omega, \gamma][X', D', \omega', \gamma'] = [X \times X', D \times X' \cup D' \times X, \omega \wedge \omega', \gamma \times \gamma'].$$

The space of *formal periods* is the localisation $\tilde{\mathbb{P}}(k)$ of $\mathbb{P}^{\text{eff}}(k)$ with respect to $[\mathbb{G}_m, \{1\}, \frac{dX}{X}, S^1]$, where S^1 is the unit circle in \mathbb{C}^* .

Remark 13.1.2. This definition is modelled after Kontsevich [Kon99] Definition 20, but does not agree with it. We will discuss this point in more detail in Remark 13.1.8.

Lemma 13.1.3. *Multiplication on $\tilde{\mathbb{P}}^{\text{eff}}(k)$ is well defined.*

Proof. This follows from the comparison result of Theorem 13.1.4. We give a direct proof for simplicity. Compatibility with relations of type 1 (linearity) or type 2 (functoriality) is obvious. This is also the case for relations of type 3 (boundary maps) in the second argument. We turn to the case of relations of type 3 in the first argument. By Proposition 2.4.3, a sign is involved. This sign is the same for the de Rham and the singular component. Hence it cancels on the product. \square

The formal period algebra is intimately related to the motivic Galois group $G_{\text{mot}}(k) = G_{\text{mot}}(k, \mathbb{Q})$, see Definition 9.1.7. By Theorem 9.1.5, the category of representations of $G_{\text{mot}}(k)$ is nothing but the category of Nori motives over k with coefficients in \mathbb{Q} .

Theorem 13.1.4. (*Nori*) *Let $k \subset \mathbb{C}$ be subfield. Let $G_{\text{mot}}(k)$ be the Tannakian dual of the category of Nori motives with \mathbb{Q} -coefficients (sic!), see Definition 9.1.7. Let $X = \text{Spec}(\tilde{\mathbb{P}}(k))$. Then X is naturally isomorphic to the torsor of isomorphisms between singular cohomology and algebraic de Rham cohomology on Nori motives. It has a natural torsor structure under the base change of $G_{\text{mot}}(k)$ to k (in the fpqc-topology on the category of k -schemes):*

$$X \times_k G_{\text{mot}}(k)_k \rightarrow X.$$

Remark 13.1.5. This was first formulated in the case $k = \mathbb{Q}$ without proof by Kontsevich as [Kon99, Theorem 6] (with attribution to Nori). In fact, we learned from Nori that this result was the starting point that led to his definition of a category of motives in the first place.

Proof. Consider the diagram $\text{Pairs}^{\text{eff}}$ of Definition 9.1.1 and the representations $T_1 = H_{\text{dR}}^*(-)$ and $T_2 = H^*(-, k)$ (sic!). Note that $H_d(X(\mathbb{C}), D(\mathbb{C}); k)$ is dual to $H^d(X(\mathbb{C}), D(\mathbb{C}); k)$.

By definition, $\tilde{\mathbb{P}}^{\text{eff}}(k)$ is the module $P_{1,2}(\text{Pairs}^{\text{eff}})$ of Definition 8.4.20. By Theorem 8.4.22, it agrees with the module $A_{1,2}(\text{Pairs}^{\text{eff}})$ of Definition 8.4.2. We are now in the situation of Section 8.4 and apply its main result, Theorem 8.4.10. In particular,

$$A_{1,2}(\text{Pairs}^{\text{eff}}) = A_{1,2}(\mathcal{MM}_{\text{Nori}}^{\text{eff}}).$$

Recall that by Theorem 9.2.22, the diagram categories of $\text{Pairs}^{\text{eff}}$ and Good^{eff} agree. The same considerations also show that the modules

$$A_{1,2}(\text{Pairs}^{\text{eff}}) = A_{1,2}(\text{Good}^{\text{eff}})$$

agree. From now on, we may work with the diagram Good^{eff} which has the advantage of admitting a commutative product structure. The algebra structures on $A_{1,2}(\text{Good}^{\text{eff}}) = P_{1,2}(\text{Good}^{\text{eff}}) = \tilde{\mathbb{P}}^{\text{eff}}(k)$ agree.

We can apply the same considerations to the localised diagram Good . As in Proposition 8.2.5, localisation on the level of diagrams or categories amounts to localisation on the algebra. Hence,

$$A_{1,2}(\text{Good}) = P_{1,2}(\text{Good}) = \tilde{\mathbb{P}}(k)$$

and

$$X = \text{Spec}(A_{1,2}(\text{Good})).$$

Also, by definition, $G_2(\text{Good})$ is the Tannakian dual of the category of Nori motives with k -coefficients. By the base change Lemma 7.5.8 it is the base change of the Tannaka dual of the category of Nori motives with \mathbb{Q} -coefficients. After these identifications, the operation

$$X \times_k G_{\text{mot}}(k)_k \rightarrow X$$

is that of Theorem 8.4.7.

By Theorem 8.4.10, it is a torsor because $\mathcal{M}\mathcal{M}_{\text{Nori}}$ is rigid. □

Remark 13.1.6. There is a slight subtlety here because our two fibre functors take values in different categories, $\mathbb{Q}\text{-Mod}$ and $k\text{-Mod}$. As

$$H^*(X, Y; k) = H^*(X, Y; \mathbb{Q}) \otimes_{\mathbb{Q}} k$$

and $\tilde{\mathbb{P}}(k)$ already is a k -algebra, the algebra of formal periods does not change when replacing \mathbb{Q} -coefficients with k -coefficients.

We can also view X as a torsor in the sense of Definition 1.7.9. The description of the torsor structure was discussed extensively in Section 8.4, in particular Theorem 8.4.10. In terms of period matrices, it is given by the formula in [Kon99]:

$$P_{ij} \mapsto \sum_{k, \ell} P_{ik} \otimes P_{k\ell}^{-1} \otimes P_{\ell j}.$$

Corollary 13.1.7. *1. The algebra of effective formal periods $\tilde{\mathbb{P}}^{\text{eff}}(k)$ remains unchanged when we restrict in Definition 13.1.1 to (X, D, ω, γ) with X affine of dimension d , D of dimension $d - 1$ and $X \setminus D$ smooth, $\omega \in H_{\text{dR}}^d(X, D)$, $\gamma \in H_d(X(\mathbb{C}), D(\mathbb{C}); \mathbb{Q})$.*

2. $\tilde{\mathbb{P}}^{\text{eff}}(k)$ is generated as a \mathbb{Q} -vector space by elements of the form $[X, D, \omega, \gamma]$ with X smooth of dimension d , D a divisor with normal crossings, $\omega \in H_{\text{dR}}^d(X, D)$, $\gamma \in H_d(X(\mathbb{C}), D(\mathbb{C}); \mathbb{Q})$.

Proof. In the proof of Theorem 13.1.4, we have already argued that we can replace the diagram $\text{Pairs}^{\text{eff}}$ by the diagram Good^{eff} . The same argument also allows us to replace it by $\text{VGood}^{\text{eff}}$.

By blowing up X , we get another good pair $(\tilde{X}, \tilde{D}, d)$. By excision, it has the same de Rham and singular cohomology as (X, D, d) . Hence, we may identify the generators. \square

Remark 13.1.8. We do not know whether it is enough to work only with formal periods of the form (X, D, ω, γ) with X smooth and D a divisor with normal crossings in Definition 13.1.1 as Kontsevich does in [Kon99, Definition 20]. By the corollary, these symbols generate the algebra, but it is not clear to us if they also give all relations. Indeed, Kontsevich in loc. cit. only imposes the relation given by the connecting morphism of triples in an even more special case.

Moreover, Kontsevich considers differential forms of top degree rather than cohomology classes. They are automatically closed. He imposes Stokes' formula as an additional relation, hence this amounts to considering cohomology classes. Note, however, that not every de Rham class is of this form in general.

All formal effective periods (X, D, ω, γ) can be “evaluated” to complex numbers by “integrating” ω along γ . More precisely, recall from Definition 5.4.1 the period pairing

$$H_{\text{dR}}^d(X, D) \times H_d^{\text{sing}}(X(\mathbb{C}), D(\mathbb{C}); \mathbb{Q}) \rightarrow \mathbb{C}.$$

The complex number obtained from $(\mathbb{G}_m, \{1\}, dX/X, S^1)$ is $2\pi i$.

Definition 13.1.9. Let

$$\text{ev} : \tilde{\mathbb{P}}(k) \rightarrow \mathbb{C},$$

be the ring homomorphism induced by the period pairing. We denote by per the \mathbb{C} -valued point of $X = \text{Spec}(\tilde{\mathbb{P}}(k))$ defined by ev .

The elements in the image are precisely the elements of the period algebra $\mathbb{P}(k)$ of Definition 11.3.1. By the results in Chapters 11, 6, and 12 (for $k = \mathbb{Q}$), it agrees with all other definitions of a period algebra. From this perspective, per is the \mathbb{C} -valued point of the torsor X of Theorem 13.1.4 comparing singular and algebraic de Rham cohomology. It is given by the period isomorphism per defined in Chapter 5.

Our results on formal period numbers have an important consequence.

Corollary 13.1.10. *The algebra $\mathbb{P}^{\text{eff}}(k)$ is \mathbb{Q} -linearly generated by periods of (X, D, ω, γ) with X smooth affine, D a divisor with normal crossings, and $\omega \in \Omega_X^d(X)$.*

This was also proved without mentioning motives as Theorem 11.4.2.

Proof. By Corollary 9.2.25, the category $\mathcal{MM}_{\text{Nori}}^{\text{eff}}$ is generated by motives of the form $H_{\text{Nori}}^n(X, Y)$ with X smooth and affine and Y a divisor with normal crossings. By Proposition 3.3.19, $H_{\text{dR}}^n(X, Y)$ is then generated by $\Omega_{X'}^d(X')$. \square

Proposition 13.1.11. *Let K/k be algebraic. Then*

$$\tilde{\mathbb{P}}(K) = \tilde{\mathbb{P}}(k),$$

and hence also

$$\mathbb{P}(K) = \mathbb{P}(k).$$

The second statement has already been proved directly as Corollary 11.3.5

Proof. It suffices to consider the case K/k finite. The general case follows by taking direct limits.

Generators of $\tilde{\mathbb{P}}(k)$ also define generators of $\tilde{\mathbb{P}}(K)$ by base change for the field extension K/k . The same is true for relations, hence we get a well-defined map $\tilde{\mathbb{P}}(k) \rightarrow \tilde{\mathbb{P}}(K)$.

We define a map in the opposite direction by viewing a K -variety as a k -variety. More precisely, let (Y, E, m) be a vertex of $\text{Pairs}^{\text{eff}}(K)$ and (Y_k, E_k, m) the same viewed as vertex of $\text{Pairs}^{\text{eff}}(k)$. As in the proof of Corollary 11.3.5, we have

$$\mathbb{H}(Y_k, E_k, m) = R_{K/k} \mathbb{H}(Y, E, m)$$

with $R_{K/k}$ as defined in Lemma 11.2.7. The same proof as in Lemma 11.2.7 (treating actual periods) also shows that the formal periods of (Y_k, E_k, m) agree with the formal periods (Y, E, m) . \square

13.2 The period conjecture

We explore the relation to transcendence questions from the point of view of Nori motives and their periods. We mainly treat the case where k/\mathbb{Q} is algebraic. We first formulate the conjecture due to Kontsevich and Zagier in this case. We then explore some consequences for motivic categories. In Section 13.2.3, we establish a connection to special cases in the literature, some of them very long-standing. For general fields beyond \mathbb{Q} , see Ayoub's survey article [Ayo14], Subsections 13.2.4 and 13.2.17, below.

13.2.1 Formulation in the number field case

Let k be an algebraic extension of \mathbb{Q} . We fix embeddings $\sigma : k \rightarrow \mathbb{C}$ and $\bar{\sigma} : \mathbb{Q} \rightarrow \mathbb{C}$. Recall that $\tilde{\mathbb{P}}(\mathbb{Q}) = \tilde{\mathbb{P}}(k) = \tilde{\mathbb{P}}(\mathbb{Q})$ under this assumption.

Conjecture 13.2.1 (Kontsevich–Zagier). *Let k/\mathbb{Q} be an algebraic field extension contained in \mathbb{C} . The evaluation map (see Definition 13.1.9)*

$$\text{ev} : \tilde{\mathbb{P}}(k) \rightarrow \mathbb{P}(k)$$

is bijective.

Remark 13.2.2. We have already seen that the map is surjective. Hence injectivity is the real issue. Equivalently, we can conjecture that $\tilde{\mathbb{P}}(k)$ is an integral domain and ev a generic point.

In the literature [And09, And04, Ayo14, BC16, Wüs12], there are sometimes alternative formulations of this conjecture, called the “Grothendieck conjecture” or the “Grothendieck period conjecture”. We will explain this a little further.

Definition 13.2.3. Let $M \in \mathcal{MM}_{\text{Nori}}$ be a Nori motive over \mathbb{Q} . Let

$$X(M)$$

be the torsor of isomorphisms between singular and algebraic de Rham cohomology on the Tannaka category generated by M and its subquotients and

$$\tilde{\mathbb{P}}(M) = \mathcal{O}(X(M))$$

be the associated ring of formal periods. If $M = H_{\text{Nori}}^*(Y)$ for a variety Y , we also write $\tilde{\mathbb{P}}(Y)$.

Let $G_{\text{mot}}(M)$ and $G_{\text{mot}}(Y)$ be the Tannaka duals of the above categories with respect to singular cohomology.

These are the finite-dimensional building blocks of $\text{Spec}(\tilde{\mathbb{P}}(k))$ and $G_{\text{mot}}(k)$, respectively.

Remark 13.2.4. By Theorem 8.4.10, the space $X(M)$ is a torsor under the k -group $G_{\text{mot}}(M) \times_{\text{Spec}(\mathbb{Q})} \text{Spec}(k)$. Hence they share all properties that can be tested after a faithfully flat base change. In particular, they have the same dimension. Moreover, $X(M)$ is smooth because $G_{\text{mot}}(M)$ is a group scheme over a field of characteristic zero.

Analogous to [Ayo14] and [And04, Prop. 7.5.2.2 and Prop. 23.1.4.1], we can ask:

Conjecture 13.2.5 (Grothendieck conjecture for Nori motives). *Let k/\mathbb{Q} be an algebraic extension contained in \mathbb{C} and $M \in \mathcal{MM}_{\text{Nori}}(k)$. The following equivalent assertions are true:*

1. *The evaluation map*

$$\mathrm{ev} : \tilde{\mathbb{P}}(M) \rightarrow \mathbb{C}$$

is injective.

2. *The point ev_M of $\mathrm{Spec}(\tilde{\mathbb{P}}(M))$ is a generic point, and $X(M)$ is connected.*
3. *The space $X(M)$ is connected, and the transcendence degree of the subfield of \mathbb{C} generated by the image of ev_M is the same as the dimension of $G_{\mathrm{mot}}(M)$.*

Note for the smooth variety $X(M)$, irreducibility and connectedness are equivalent.

Proof of equivalence. Assume that ev is injective. Then $\tilde{\mathbb{P}}(M)$ is contained in the field \mathbb{C} , hence integral. The map to \mathbb{C} factors via the residue field of a point. If ev is injective, this has to be the generic point. The subfield generated by $\mathrm{ev}(M)$ is isomorphic to the function field. Its transcendence degree is the dimension of the integral domain.

Conversely, if $X(M)$ is connected, then it is integral because it is already smooth. If ev factors the generic point, its function field embeds into \mathbb{C} and hence $\tilde{\mathbb{P}}(M)$ does. If the subfield generated by the image of ev in \mathbb{C} has the maximal possible transcendence degree, then ev has to be generic. \square

Proposition 13.2.6. *The Grothendieck Conjecture 13.2.5 is true for all M if and only if Kontsevich–Zagier’s Conjecture 13.2.1 holds.*

Proof. By construction, we have

$$\tilde{\mathbb{P}}(k) = \mathrm{colim}_M \tilde{\mathbb{P}}(M).$$

Injectivity of the evaluation maps on the level of every M implies injectivity of the transition maps and injectivity of ev on the union. Conversely, we have to show injectivity of $\tilde{\mathbb{P}}(M) \rightarrow \tilde{\mathbb{P}}(k)$ for all M . This can be tested after a faithfully flat base change, hence it suffices to show injectivity of $\mathcal{O}(G_{\mathrm{mot}}(M)) \rightarrow \mathcal{O}(G_{\mathrm{mot}}(k))$. This holds by Proposition 7.5.9. \square

13.2.2 Consequences

Corollary 13.2.7. 1. *Assume Kontsevich–Zagier’s Conjecture 13.2.1 holds.*

Then the motivic Galois group $G_{\mathrm{mot}}(\overline{\mathbb{Q}})$ of the category of Nori motives with \mathbb{Q} -coefficients is connected.

2. *Let M be a Nori motive over $\overline{\mathbb{Q}}$. Assume the Grothendieck Conjecture 13.2.5 holds for M . Then $G_{\mathrm{mot}}(M)$ is connected.*

Proof. By assumption, $\mathrm{Spec}(\tilde{\mathbb{P}}(\overline{\mathbb{Q}}))$ is a connected $\overline{\mathbb{Q}}$ -scheme, hence geometrically connected. It remains connected under any base change. As it is a $G_{\mathrm{mot}}(\overline{\mathbb{Q}})_{\overline{\mathbb{Q}}}$ -torsor, this implies that $G_{\mathrm{mot}}(\overline{\mathbb{Q}})$ is connected.

The argument for $G_{\text{mot}}(M)$ is the same. □

Recall from Theorem 10.1.1 the faithful exact tensor functor

$$\mathcal{M}\mathcal{M}_{\text{Nori},\mathbb{Q}} \rightarrow \mathcal{M}\mathcal{M}_{\text{AH}}$$

which maps the motive of an algebraic variety to its absolute Hodge motive. Moreover, the choice of an embedding $\sigma : k \rightarrow \mathbb{C}$ defines a forgetful functor $\mathcal{M}\mathcal{M}_{\text{AH}} \rightarrow (k, \mathbb{Q})\text{-Vect}$ to the category of pairs of Definition 5.1.1. It maps a mixed realisation A (see Definition 6.3.1) to the components $(A_{\text{dR}}, A_\sigma, I_{\text{dR},\sigma})$.

Proposition 13.2.8. *Let k be algebraic over \mathbb{Q} and $\sigma : k \rightarrow \mathbb{C}$ an embedding. Assume the Period Conjecture 13.2.1 holds. Then the functor $\mathcal{M}\mathcal{M}_{\text{Nori}} \rightarrow \mathcal{M}\mathcal{M}_{\text{AH}}$ is an equivalence of categories and the functor to $(k, \mathbb{Q})\text{-Vect}$ is fully faithful with image closed under subquotients.*

Proof. By construction, the period map $\tilde{\mathbb{P}}(k) \rightarrow \mathbb{C}$ factors via the formal period algebra of $\mathcal{M}\mathcal{M}_{\text{AH}}$. Hence the Period Conjecture implies that $\tilde{\mathbb{P}}(k) \rightarrow \mathbb{P}(\mathcal{M}\mathcal{M}_{\text{AH}})$ is injective. They are torsors, hence we also have an injection $\mathcal{O}(G_{\text{mot}}(k)) \rightarrow \mathcal{O}(G(\mathcal{M}\mathcal{M}_{\text{AH}}))$. By [Wat79, Proposition 14.1], this implies that the homomorphism of affine group schemes $G(\mathcal{M}\mathcal{M}_{\text{AH}}) \rightarrow G_{\text{mot}}(k)$ is faithfully flat. As in [DM82, Proposition 2.21] this translates into the tensor functor $\mathcal{M}\mathcal{M}_{\text{Nori}} \rightarrow \mathcal{M}\mathcal{M}_{\text{AH}}$ being fully faithful and the image closed under subquotients. Moreover, in both categories all objects are subquotients of objects in the image of the category of geometric motives. Hence, the two categories are actually equivalent.

The same line of argument can also be applied to the image of $\mathcal{M}\mathcal{M}_{\text{Nori}}$ in $(k, \mathbb{Q})\text{-Vect}$. □

Remark 13.2.9. The fully faithfulness of $\mathcal{M}\mathcal{M}_{\text{Nori}} \rightarrow (k, \mathbb{Q})\text{-Vect}$ seems weaker than the period conjecture. For $V \in (k, \mathbb{Q})\text{-Vect}$, the formal period algebra of the tensor category generated by V is in general *not* embedded into \mathbb{C} via the period isomorphism. An example is the case $k = \mathbb{Q}$ with $V = (\mathbb{Q}^2, \mathbb{Q}^2, \phi)$ with ϕ given by the matrix $\begin{pmatrix} 1 & \sqrt{2} \\ 0 & 1 \end{pmatrix}$. Its period algebra is the field $\mathbb{Q}(\sqrt{2})$. However, its formal period algebra is the group of unipotent matrices $\begin{pmatrix} 1 & \star \\ 0 & 1 \end{pmatrix} = \mathbb{A}^1$. Hence the period conjecture implies that V does not occur in the image of the category of motives.

Recall that by Theorem 10.2.7 the semi-simple category of pure Nori motives is equivalent to André’s category of pure motives for motivated cycles, see Definition 6.1.5. We specialise to this case.

Corollary 13.2.10. *Assume the Grothendieck Conjecture 13.2.5 for all pure Nori motives, i.e., for all objects of AM. Then:*

1. *The functor $\text{AM} \rightarrow \mathcal{M}\mathcal{M}_{\text{AH}}^{\text{pure}}$ is an equivalence of categories.*

- 2. The embedding of $\mathcal{M}\mathcal{M}_{\text{AH}}^{\text{pure}}$ into $(k, \mathbb{Q})\text{-Vect}$ is fully faithful.
- 3. All algebraic relations between periods of smooth projective varieties are induced by algebraic cycles on smooth projective varieties.

Proof. The first two assertions follow by the same argument as in the proof of Proposition 13.2.8. By the period conjecture, all relations between period numbers are induced by relations of formal periods. By construction of the formal period algebra, all linear relations between formal periods are induced by morphisms of AM, hence by algebraic cycles. By the period conjecture, algebraic relations are linear relations between periods for tensor powers, hence the same is true. \square

We compare this to the implication of the Hodge conjecture. As pointed out to us by Yves André, there is a relation, but no implication in either direction.

Recall from Chapter 6 the sequence of functors

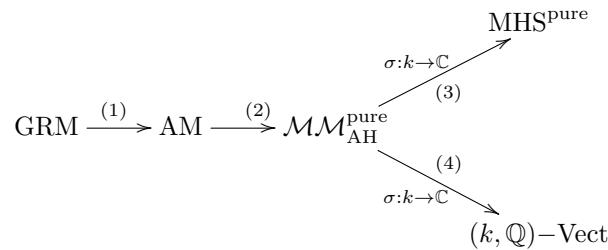

where GRM is the category of Grothendieck motives, AM is the category of André motives, $\mathcal{M}\mathcal{M}_{\text{AH}}^{\text{pure}}$ the category of pure absolute Hodge motives, and MHS^{pure} the category of pure \mathbb{Q} -Hodge structures. The last two functors depend on the choice of an embedding of k into \mathbb{C} . We have just shown that the period conjecture implies that (3) is an equivalence and (4) is fully faithful.

As already discussed in Chapter 6, the Hodge conjecture implies that (1) and (2) are equivalences of semi-simple abelian categories. For an algebraically closed field (in our context $k = \overline{\mathbb{Q}}$), the functor (3) to the category of Hodge structures is then fully faithful.

The same relations also hold for the Tannakian category generated by a single pure motive.

Definition 13.2.11. Let V be a polarisable pure Hodge structure. The Mumford–Tate group $G = \text{MT}(V)$ of V is the smallest \mathbb{Q} -algebraic subgroup of $\text{GL}(V)$ such that the Hodge representation $h : \mathbb{S} \rightarrow \text{GL}(V_{\mathbb{R}})$ factors via G as $h : \mathbb{S} \rightarrow G_{\mathbb{R}}$. Here, $\mathbb{S} = \text{Res}_{\mathbb{C}/\mathbb{R}} \mathbb{G}_m$ is the Deligne torus. It is precisely the \mathbb{Q} -algebraic subgroup of $\text{GL}(V_{\mathbb{R}})$ that fixes all Hodge tensors in all tensor powers $\bigoplus V^{\otimes m} \otimes V^{\vee \otimes n}$, see [Mum66].

Alternatively, $\text{MT}(V)$ can be understood as the Tannaka dual of the Tannaka subcategory of the category of Hodge structures generated by V . It is

closed under subquotients because V is semi-simple. This also implies that $\mathrm{MT}(V)$ is a reductive \mathbb{Q} -algebraic group by [GGK12, Chapter I].

Proposition 13.2.12. *Let $k = \bar{\mathbb{Q}}$ and let Y be smooth and projective. Assume that the Hodge conjecture holds for all powers of Y . Then $G_{\mathrm{mot}}(Y)$ is the same as the Mumford–Tate group of Y .*

Proof. By Proposition 10.2.1 the Tannaka subcategory of $\mathcal{M}\mathcal{M}_{\mathrm{Nori}}$ generated by $M = H_{\mathrm{Nori}}^*(Y)$ agrees with the Tannaka subcategory of GRM generated by M . Note that the statement of Proposition 10.2.1 assumes the full Hodge conjecture. The same argument also gives the statement on the subcategories under the weaker assumption. For the rest of the argument we refer to Lemme 7.2.2.1 and Remarque 23.1.4.2 of [And04]. It amounts to saying that equivalent Tannaka categories have isomorphic Tannaka duals. \square

This means that under the Hodge conjecture, the period conjecture can be reformulated in terms of the Mumford Tate group. This brings us back to earlier versions of the period conjecture.

13.2.3 Special cases and the older literature

The third version of Conjecture 13.2.5 is very close to the original point of view taken by Grothendieck in the pure case.

Corollary 13.2.13 (Period Conjecture). *Let Y be a smooth, projective variety over \mathbb{Q} . Assume Conjecture 13.2.5 for powers of Y and the Hodge conjecture. Then all polynomial relations among the periods of Y are of a motivic nature, i.e., they are induced by algebraic cycles (correspondences) in powers of Y .*

In the case of elliptic curves this was stated as a conjecture by Grothendieck in [Gro66].

Proof. As in the proof of Proposition 13.2.12, the Hodge conjecture for Y and its powers implies that all morphisms in the category of motives generated by $M = H^*(V)$ are given by algebraic cycles. The rest of the argument is the same as in the proof of Corollary 13.2.10, but more precise in only using cycles on Y and its tensor powers. \square

Arnold [Arn90, pg. 93] remarked in a footnote that this is related to a conjecture of Leibniz which he made in a letter to Huygens from 1691. Leibniz essentially claims that all periods of *generic* meromorphic 1-forms are transcendental. Of course, the precise meaning of “generic” is the essential question. Leibniz’s conjecture can be rephrased in modern form as in [Wüs12]:

Conjecture 13.2.14 (Leibniz’s Integral Conjecture). *Any period integral of a rational algebraic 1-form ω on a smooth projective variety X over a number field k over a path γ with $\partial\gamma \subset D$ (the polar divisor of ω) which does not come from a proper mixed Hodge substructure $H \subset H_1(X \setminus D)$ over k is transcendental.*

This is only a statement about periods for $H^1(X, D)$ (or, by duality $H_1(X \setminus D)$) on curves. The Leibniz conjecture follows essentially from the period conjecture in the case $i = 1$, since the Hodge conjecture holds on $H^1(X) \otimes H^1(X) \subset H^2(X)$. This conjecture of Leibniz seems to be still open. See also [BC16] for strongly related questions.

Wüstholz [Wüs12] has related this problem to many other transcendence results. One can give transcendence proofs assuming this conjecture:

Example 13.2.15. Let us show that $\log(\alpha)$ is transcendental for every algebraic $\alpha \neq 0, 1$ under the assumption of the Leibniz conjecture. One takes $X = \mathbb{P}^1$, and $\omega = d\log(z)$ and $\gamma = [1, \alpha]$. The polar divisor of ω is $D = \{0, \infty\}$, and the Hodge structure $H_1(X \setminus D) = H_1(\mathbb{C}^\times) = \mathbb{Z}(1)$ is irreducible as a Hodge structure. Hence, $\log(\alpha)$ is transcendental assuming Leibniz’s conjecture. A direct proof of this can be found in [BW07].

There are also examples of elliptic curves in [Wüs12] related to Chudnovsky’s theorem, which we mention below.

The third form of Conjecture 13.2.5 is also very useful in a computational sense. In this case, assuming the Hodge conjecture for all powers of Y , the motivic Galois group $G_{\text{mot}}(Y)$ is the same as the *Mumford–Tate group* $\text{MT}(Y)$ by Proposition 13.2.12.

André shows in [And04, Remark 23.1.4.2]:

Corollary 13.2.16. *Let Y be a smooth, projective variety over \mathbb{Q} and assume that the Hodge conjecture holds for all powers of Y . Then, assuming Grothendieck’s conjecture,*

$$\text{trdeg}_{\mathbb{Q}} \mathbb{P}(Y) = \dim_{\mathbb{Q}} \text{MT}(Y).$$

Proof. We view the right-hand side as $G_{\text{mot}}(Y_{\overline{\mathbb{Q}}})$ by Proposition 13.2.12. By [And04, Paragraph 7.6.4], it is of finite index in $G_{\text{mot}}(Y)$, hence has the same dimension. It also has the same dimension as the torsor $\tilde{\mathbb{P}}(Y)$. Under Grothendieck’s conjecture, this is given by the transcendence degree of $\mathbb{P}(Y)$, see Conjecture 13.2.5. \square

The assertion of the corollary can be tested unconditionally. Hence this is a reasonable testing conjecture for transcendence questions.

Remark 13.2.17. If k is a number field, and Y is defined over k , then one would also have under Grothendieck’s conjecture

$$\text{trdeg}_k \mathbb{P}(Y) = \text{trdeg}_{\mathbb{Q}} \mathbb{P}(Y) = \dim_k G_{\text{mot}}(Y) = \dim_{\mathbb{Q}} \text{MT}(Y).$$

However, if k has positive transcendence degree, then this has to be modified, see [And04, §23.4.1] and [Ayo14, Remark 24]: In general, one only conjectures

$$\mathrm{trdeg}_{\mathbb{Q}}\mathbb{P}(Y) \geq \dim_k G_{\mathrm{mot}}(Y).$$

If, moreover, the embedding $k \hookrightarrow \mathbb{C}$ is sufficiently “general” in the sense of [Ayo14, Remark 15], then one expects to have

$$\mathrm{trdeg}_{\mathbb{Q}}\mathbb{P}(Y) = \dim_k G_{\mathrm{mot}}(Y) + \mathrm{trdeg}_{\mathbb{Q}}(k).$$

Example 13.2.18. (Tate motives) If the motive of Y is a Tate motive, e.g., $Y = \mathbb{P}^n$, then the conjecture is true, since $2\pi i$ is transcendental. The Mumford–Tate group is the 1-torus in this case. More generally, the conjecture holds for Artin–Tate motives, since the transcendence degree remains 1.

Example 13.2.19. (Elliptic curves) Let E be an elliptic curve over \mathbb{Q} . Then the Mumford–Tate group of E is either a 2-torus if E has complex multiplication, or $\mathrm{GL}_{2,\mathbb{Q}}$ otherwise (cf. [Mum66]). Hence, the transcendence degree of $\mathbb{P}(E)$ is either 2 or 4. G.V. Chudnovsky [Chu80] has proved that $\mathrm{trdeg}_{\mathbb{Q}}\mathbb{P}(E) = 2$ if E is an elliptic curve with complex multiplication, and it is ≥ 2 for all elliptic curves over \mathbb{Q} . Note that in this situation we actually have 5 period numbers $\omega_1, \omega_2, \eta_1, \eta_2$ and π (see Section 14.4 for more details), but they are related by Legendre’s relation $\omega_2\eta_1 - \omega_1\eta_2 = 2\pi i$, so that the transcendence degree cannot go beyond 4. Hence, it remains to show that the transcendence degree of the periods of an elliptic curve without complex multiplication is precisely 4, as predicted by the conjecture.

13.2.4 The function field case

In the case of a transcendental extension k/\mathbb{Q} , the Kontsevich–Zagier and Grothendieck conjecture does not generalise easily, unless the embedding of $k \hookrightarrow \mathbb{C}$ is “general” in some sense, see [Ayo14, Remark 15]. However, a relative function field version of Conjecture 13.2.1 does indeed hold, as we will explain now. It was found independently by Ayoub [Ayo15, Ayo16] and Nori [Nor06]. We will explain both versions. In the following, we fix a field k of finite type over \mathbb{Q} , and embeddings $\mathbb{Q} \hookrightarrow k \hookrightarrow \mathbb{C}$.

Ayoub’s approach: Ayoub first proposes an alternative definition of $\tilde{\mathbb{P}}(\mathbb{Q})$. His motivation is to construct a variation of Definition 13.1.1, in which he uses only quadruples (X, Z, ω, γ) , where after [Ayo14, Section 2.2]:

- $X = \mathrm{Spec}(A)$ for A any étale sub- $\mathbb{Q}[z_1, \dots, z_n]$ -algebras of the ring of convergent power series with radius strictly larger than 1.
- $Z \subset X$ is the normal crossing divisor given by $\prod_i z_i(1 - z_i) = 0$.
- $\gamma : [0, 1]^n \rightarrow X^{\mathrm{an}}$ is the canonical lift of the obvious inclusion $[0, 1]^n \rightarrow \mathbb{C}^n$.

- $\omega = f \cdot dz_1 \wedge \dots \wedge dz_n$ with $f \in A$, a top degree differential form.

The actual definition, however, is quite different and is as follows:

Definition 13.2.20. Denote by $\bar{\mathbb{D}}^n$ the closed polydisk of radius 1 in \mathbb{C}^n and by $\mathcal{O}(\bar{\mathbb{D}}^n)$ the ring of convergent power series in the variables z_1, \dots, z_n with radius of convergence strictly larger than 1. Let $\mathcal{O}_{k\text{-alg}}(\bar{\mathbb{D}}^n)$ be the k -subspace of power series which are algebraic over the field $k(z_1, \dots, z_n)$ of rational functions, and

$$\mathcal{O}_{k\text{-alg}}(\bar{\mathbb{D}}^\infty) = \bigcup_{n=1}^\infty \mathcal{O}_{k\text{-alg}}(\bar{\mathbb{D}}^n).$$

In particular, for $n = 0$, one has $\mathcal{O}_{k\text{-alg}}(\bar{\mathbb{D}}^0) = \bar{k}$. Now define a ring $\tilde{\mathbb{P}}_{\text{Ay}}^{\text{eff}}(k)$ of *effective formal Ayoub periods* over k as the quotient of $\mathcal{O}_{k\text{-alg}}(\bar{\mathbb{D}}^\infty)$ by the sub- k -vector space spanned by the elements of the form

$$\frac{\partial f}{\partial z_i} - f|_{z_i=1} + f|_{z_i=0}$$

for $f \in \mathcal{O}_{k\text{-alg}}(\bar{\mathbb{D}}^\infty)$ and $i \geq 1$.

Finally, we denote by $\tilde{\mathbb{P}}_{\text{Ay}}(k)$ the algebra of *formal Ayoub periods* over k , defined as the localisation of $\tilde{\mathbb{P}}_{\text{Ay}}^{\text{eff}}(k)$ by some (non-unique) element of $\mathcal{O}_{\mathbb{Q}\text{-alg}}(\bar{\mathbb{D}}^1) \subset \mathcal{O}_{k\text{-alg}}(\bar{\mathbb{D}}^1)$ whose integral over $[0, 1]$ is $2\pi i$.

There is a natural evaluation map $\text{ev} : \tilde{\mathbb{P}}_{\text{Ay}}^{\text{eff}}(k) \rightarrow \mathbb{C}$, induced by the integral

$$\mathcal{O}_{k\text{-alg}}(\bar{\mathbb{D}}^\infty) \rightarrow \mathbb{C}, f \mapsto \int_{[0,1]^\infty} f,$$

see [Ayo15, Section 1.1]. This means that for every n and $f = f(z_1, \dots, z_n)$, one has $\text{ev}(f) = \int_{[0,1]^n} f$. The integral always exists, as the cube $[0, 1]^n$ is compact. The dependence on n is canonical, as the volume of the interval $[0, 1]$ is 1. This new definition compares nicely to the old one:

Proposition 13.2.21 (Ayoub). *There is an isomorphism $\tilde{\mathbb{P}}_{\text{Ay}}(\mathbb{Q}) \rightarrow \tilde{\mathbb{P}}(\mathbb{Q})$, induced by (using the terminology from Definition 13.1.1)*

$$f \mapsto (X, Z, f \cdot dz_1 \wedge \dots \wedge dz_n, [0, 1]^n),$$

for $f \in A$, and the evaluation maps are comparable under this isomorphism.

Proof. This is [Ayo14, Proposition 11], and [Ayo15, Theorems 1.8 and 4.25]. □

To state the function field version due to Ayoub, we first define *Ayoub period power series*:

Definition 13.2.22. Let $\mathcal{O}_{\mathbb{C}\text{-alg}}^\dagger(\bar{\mathbb{D}}^n)$ be the sub- \mathbb{C} -vector space of the Laurent series ring $\mathcal{O}(\bar{\mathbb{D}}^n)[[\omega]][\omega^{-1}]$ consisting of all Laurent series

$$F = \sum_{i > -\infty} f_i(z_1, \dots, z_n) \cdot \omega^i$$

with coefficients in $\mathcal{O}(\bar{\mathbb{D}}^n)$, which are algebraic over the field $\mathbb{C}(\omega, z_1, \dots, z_n)$. More generally, for any field $k \subset \mathbb{C}$, one defines $\mathcal{O}_{k\text{-alg}}^\dagger(\bar{\mathbb{D}}^n)$ to be those power series F which are algebraic over the field $k(\omega, z_1, \dots, z_n)$. Furthermore, we set

$$\mathcal{O}_{k\text{-alg}}^\dagger(\bar{\mathbb{D}}^\infty) := \bigcup_{n=1}^{\infty} \mathcal{O}_{k\text{-alg}}^\dagger(\bar{\mathbb{D}}^n).$$

Define the ring of period power series $\tilde{\mathbb{P}}_{\text{Ay}}^\dagger(k)$ as the quotient of $\mathcal{O}_{k\text{-alg}}^\dagger(\bar{\mathbb{D}}^\infty)$ by the two relations:

- $\frac{\partial F}{\partial z_i} - F|_{z_i=1} + F|_{z_i=0}$ for $F \in \mathcal{O}_{k\text{-alg}}^\dagger(\bar{\mathbb{D}}^\infty)$ and $i \geq 1$.
- $\left(g - \int_{[0,1]^\infty} g\right) \cdot F$ for g and F both in $\mathcal{O}_{k\text{-alg}}^\dagger(\bar{\mathbb{D}}^\infty)$, such that g does not depend on the variable ω , and g and F do not depend simultaneously on any of the variables z_i . This slightly complicated condition is a consequence of Ayoub's proof.

By Stokes' theorem, there is a canonical evaluation mapping

$$\text{ev} : \tilde{\mathbb{P}}_{\text{Ay}}^\dagger(k) \rightarrow \mathbb{C}((\omega)), F = \sum_{i > -\infty} f_i \cdot \omega^i \mapsto \sum_{i > -\infty} \left(\int_{[0,1]^\infty} f_i \right) \cdot \omega^i.$$

Power series which are in the image of this map are called *k-series of periods* by Ayoub [Ayo15, Definition 1.6]. The function field version of the Kontsevich–Zagier conjecture can then be stated as

Theorem 13.2.23 (Ayoub). *The evaluation map $\text{ev} : \tilde{\mathbb{P}}_{\text{Ay}}^\dagger(k) \rightarrow \mathbb{C}((\omega))$ is injective.*

Proof. See [Ayo15, Théorème 4.25] and [Ayo14, Theorem 48]. \square

In Ayoub's note [Ayo16] the statements of [Ayo15] are modified and slightly improved.

Nori's approach: This approach from [Norb], only with a sketch of the steps in the proof, is quite different from Ayoub's, although it also uses analytic functions, and the final statement is similar. First, let L be a finitely generated transcendental extension of a number field k . This defines \mathbb{Q} -algebras of effective periods $\tilde{\mathbb{P}}^{\text{eff}}(L)$ and $\tilde{\mathbb{P}}^{\text{eff}}(k)$, together with a comparison map $\tilde{\mathbb{P}}^{\text{eff}}(k) \rightarrow \tilde{\mathbb{P}}^{\text{eff}}(L)$.

Now, let B be a finitely generated algebra with quotient field L . For simplicity, the reader may assume that $L = k(\omega)$ is a one-variable transcendental

extension, then the results compare directly to Ayoub’s approach. Then, let \mathcal{R} be the field of meromorphic functions on the analytification of the algebraic variety $X = \text{Spec}(B)$. In the special case, we have $B = k[\omega]$ and $\mathcal{R} = \mathbb{C}((\omega))$.

Then the idea is to “spread out” periods over L to power series in \mathcal{R} , and Nori asserts that there is an evaluation map

$$\text{ev} : \tilde{\mathbb{P}}^{\text{eff}}(L) \rightarrow \mathcal{R},$$

which is compatible with the evaluation map on $\tilde{\mathbb{P}}^{\text{eff}}(k)$ by inclusion, and the Kontsevich–Zagier evaluation map $\tilde{\mathbb{P}}^{\text{eff}}(L) \rightarrow \mathbb{C}$ is obtained by evaluating the power series at the generic point corresponding to L .

The function field version of the Kontsevich–Zagier conjecture can then be stated as

Theorem 13.2.24 (Nori). *The evaluation map $\text{ev} : \mathbb{C} \otimes_{\tilde{\mathbb{P}}^{\text{eff}}(k)} \tilde{\mathbb{P}}^{\text{eff}}(L) \rightarrow \mathcal{R}$ is injective.*

Proof. See [Norb, Main Theorem, page 6]. A proof is sketched on the same page. □

13.3 The case of 0-dimensional varieties

We go through all objects in the baby case of Artin motives, i.e., those generated by 0-dimensional varieties. We work with rational coefficients throughout.

Recall that we discussed the subcategory of Artin motives $\mathcal{MM}_{\text{Nori}, \mathbb{Q}}^0$ carefully in Section 9.4. The diagram $\text{Var}^0 \subset \text{Pairs}^0$ was defined by the opposite category of 0-dimensional k -varieties, or equivalently, the category of finite separable k -algebras. We established that $\mathcal{MM}_{\text{Nori}, \mathbb{Q}}^0 = \mathcal{C}(\text{Var}^0, H^*)$. Its Tannaka dual is $\text{Gal}(\bar{k}/k)$ viewed as pro-finite group scheme over \mathbb{Q} .

Definition 13.3.1. Let $\tilde{\mathbb{P}}^0(k)$ be the space of periods attached to $\mathcal{MM}_{\text{Nori}}^0$.

Our aim is to show $\tilde{\mathbb{P}}^0(k) \cong \bar{k}$ with the natural operation of the Galois group. In particular, the period conjecture (in any version) holds for 0-motives. This is essentially Grothendieck’s treatment of Galois theory.

Let K/k be a finite Galois extension and $Y = \text{Spec}(K)$. In Section 9.4, we established that

$$H^0(Y(\mathbb{C}), \mathbb{Q}) = \text{Maps}(Y(\mathbb{C}), \mathbb{Q}) = \text{Maps}(\text{Hom}_{k\text{-alg}}(K, \mathbb{C}), \mathbb{Q}).$$

Note that $H_{\text{dR}}^0(\text{Spec}(K)) = K$ and the period isomorphism

$$\begin{aligned} K \otimes_k \mathbb{C} &\rightarrow \text{Maps}(\text{Hom}_{k\text{-alg}}(K, \mathbb{C}), \mathbb{Q}) \otimes_{\mathbb{Q}} \mathbb{C}, \\ v &\mapsto (f \mapsto f(v)) \end{aligned}$$

is the base change of the same map with values in K

$$K \otimes_k K \rightarrow \text{Maps}(\text{Hom}_{k\text{-alg}}(K, K), \mathbb{Q}) \otimes_{\mathbb{Q}} K.$$

In particular, all entries of the period matrix are in K . The space of formal periods of K is generated by the symbols (ω, γ) where ω runs through a k -basis of K and γ through the set $\text{Hom}_{k\text{-alg}}(K, K)$, viewed as basis of a \mathbb{Q} -vector space. The relations coming from the operation of the Galois group bring us down to a space of dimension $[K : k]$, hence the evaluation map is injective. Passing to the limit, we get

$$\tilde{\mathbb{P}}^0(k) = \bar{k}.$$

Note that we would get the same result by applying Proposition 13.1.11 and working only over \bar{k} . The operation of $\text{Gal}(\bar{k}/k)$ on $\tilde{\mathbb{P}}^0(k)$ is the natural one. More precisely, $g \in \text{Gal}(\bar{k}/k)$ operates by applying g^{-1} because the operation is defined via γ , which is in the dual space. Note that the dimension of $\tilde{\mathbb{P}}^0(k)$ is also 0.

We have seen from general principles that the operation of $\text{Gal}(\bar{k}/k)$ on $X^0(k) = \text{Spec}(\tilde{\mathbb{P}}^0(k))$ defines a torsor. In this case, we can trivialise it already over \bar{k} . We have

$$\text{Mor}_k(\text{Spec}(\bar{k}), X^0(k)) = \text{Hom}_{k\text{-alg}}(\bar{k}, \bar{k}).$$

By Galois theory, the operation of $\text{Gal}(\bar{k}/k)$ on this set is simply transitive.

When we apply the same discussion to the ground field \bar{k} , we get $G_{\text{mot}}^0(\bar{k}) = \text{Gal}(\bar{k}/\bar{k})$ and $\tilde{\mathbb{P}}^0(\bar{k}) = \bar{k}$. We see that the (formal) period algebra has not changed, but the motivic Galois group has. It is still true that $\text{Spec}(\bar{k})$ is a torsor under the motivic Galois group, but now viewed as \bar{k} -schemes, where both consist of a single point!

Part IV
Examples

Chapter 14

Elementary examples

14.1 Logarithms

In this section, we give one of the simplest examples of a cohomological period in the sense of Chapter 11. Let

$$X := \mathbb{A}_{\mathbb{Q}}^1 \setminus \{0\} = \text{Spec}(\mathbb{Q}[t, t^{-1}])$$

be the affine line with the point 0 removed and

$$D := \{1, \alpha\} \quad \text{with } \alpha \neq 0, 1 \quad \text{and } \alpha \in \mathbb{Q}$$

be a divisor on X . The singular homology of the pair $(X(\mathbb{C}), D(\mathbb{C})) = (\mathbb{C}^\times, \{1, \alpha\})$ is generated by a small loop σ turning counter-clockwise around 0 once and the interval $[1, \alpha]$. In order to compute the algebraic de Rham cohomology of (X, D) , we first note that by Section 3.1, $H_{\text{dR}}^\bullet(X, D)$ is the cohomology of the complex of global sections of the cone complex $\tilde{\Omega}_{X, D}^\bullet$, since X is affine and the sheaves $\tilde{\Omega}_{X, D}^p$ are quasi-coherent, hence acyclic for the global sections functor. We spell out the complex $\Gamma(X, \tilde{\Omega}_{X, D}^\bullet)$ in detail

$$\begin{array}{c}
 0 \\
 \uparrow \\
 \Gamma(X, \tilde{\Omega}_{X, D}^1) = \Gamma(X, \Omega_X^1 \oplus \bigoplus_j i_* \mathcal{O}_{D_j}) = \mathbb{Q}[t, t^{-1}]dt \oplus \mathbb{Q} \oplus \mathbb{Q} \\
 \uparrow d \\
 \Gamma(X, \mathcal{O}_X) = \mathbb{Q}[t, t^{-1}]
 \end{array}$$

(d being the obvious map) and observe that the evaluation map

We will see further examples of triple coproducts soon. Their properties are not yet fully understood.

14.2 More logarithms

In this section, we describe a variant of the cohomological period in the previous section. We define (for $\alpha, \beta \in \mathbb{Q}$)

$$D := \{1, \alpha, \beta\} \quad \text{with} \quad \alpha \neq 0, 1 \quad \text{and} \quad \beta \neq 0, 1, \alpha,$$

but keep $X := \mathbb{A}_{\mathbb{Q}}^1 \setminus \{0\} = \text{Spec}(\mathbb{Q}[t, t^{-1}])$.

Then $H_1^{\text{sing}}(X, D; \mathbb{Q})$ is generated by the loop σ from the first example and the intervals $[1, \alpha]$ and $[\alpha, \beta]$. Hence, the differential forms $\frac{dt}{t}$, dt and $2t dt$ give a basis of $H_{\text{dR}}^1(X, D)$. If they were linearly dependent, the period matrix P would not be of full rank

$$\begin{array}{c|ccc} & \frac{dt}{t} & dt & 2t dt \\ \hline \sigma & 2\pi i & 0 & 0 \\ [1, \alpha] & \log \alpha & \alpha - 1 & \alpha^2 - 1 \\ [\alpha, \beta] & \log\left(\frac{\beta}{\alpha}\right) & \beta - \alpha & \beta^2 - \alpha^2. \end{array}$$

We observe that $\det P = 2\pi i(\alpha - 1)(\beta - \alpha)(\beta - 1) \neq 0$.

The inverse matrix of P is

$$P^{-1} = \begin{pmatrix} \frac{1}{2\pi i} & 0 & 0 \\ \frac{(\alpha^2 - 1) \log \beta - (\beta^2 - 1) \log \alpha}{2\pi i(\beta - \alpha)(\alpha - 1)(\beta - 1)} & \frac{\alpha + \beta}{(\alpha - 1)(\beta - 1)} & \frac{\alpha + 1}{(\alpha - \beta)(\beta - 1)} \\ \frac{-(\alpha - 1) \log \beta + (\beta - 1) \log \alpha}{2\pi i(\beta - \alpha)(\alpha - 1)(\beta - 1)} & \frac{-1}{(\alpha - 1)(\beta - 1)} & \frac{-1}{(\alpha - \beta)(\beta - 1)} \end{pmatrix},$$

and therefore we get for the triple coproduct for the entry $\log(\alpha)$:

$$\begin{aligned} \Delta(\log \alpha) &= \log \alpha \otimes \frac{1}{2\pi i} \otimes 2\pi i \\ &+ (\alpha - 1) \otimes \frac{-(\alpha^2 - 1) \log \beta + (\beta^2 - 1) \log \alpha}{2\pi i(\beta - \alpha)(\alpha - 1)(\beta - 1)} \otimes 2\pi i \\ &+ (\alpha - 1) \otimes \frac{\alpha + \beta}{(\alpha - 1)(\beta - 1)} \otimes \log \alpha \\ &+ (\alpha - 1) \otimes \frac{\alpha + 1}{(\alpha - \beta)(\beta - 1)} \otimes \log\left(\frac{\beta}{\alpha}\right) \\ &+ (\alpha^2 - 1) \otimes \frac{(\alpha - 1) \log \beta - (\beta - 1) \log \alpha}{2\pi i(\beta - \alpha)(\alpha - 1)(\beta - 1)} \otimes 2\pi i \\ &+ (\alpha^2 - 1) \otimes \frac{-1}{(\alpha - 1)(\beta - 1)} \otimes \log \alpha \end{aligned}$$

$$\begin{aligned}
& + (\alpha^2 - 1) \otimes \frac{-1}{(\alpha - \beta)(\beta - 1)} \otimes \log \left(\frac{\beta}{\alpha} \right) \\
= & \log \alpha \otimes \frac{1}{2\pi i} \otimes 2\pi i - 1 \otimes \frac{\log \alpha}{2\pi i} \otimes 2\pi i + 1 \otimes 1 \otimes \log \alpha.
\end{aligned}$$

Note that this is compatible with Equation 14.2. It would be important to work out the functorial behaviour of triple coproducts in general.

14.3 Quadratic forms

Let

$$\begin{array}{ccc}
Q(\underline{x}) : & \mathbb{Q}^3 & \longrightarrow \mathbb{Q} \\
& \underline{x} = (x_0, x_1, x_2) & \mapsto \underline{x} A \underline{x}^T
\end{array}$$

be a quadratic form with $A \in \mathbb{Q}^{3 \times 3}$ an invertible and symmetric matrix.

The zero-locus of $Q(\underline{x})$

$$\bar{X} := \{[\underline{x}] \in \mathbb{P}^2(\mathbb{Q}) \mid Q(\underline{x}) = 0\}$$

is a *quadratic* or non-degenerate *conic*. We are interested in its affine piece

$$X := \bar{X} \cap \{x_0 \neq 0\} \subset \mathbb{Q}^2 \subset \mathbb{P}^2(\mathbb{Q}).$$

We show that we can assume $Q(\underline{x})$ to be of a particularly nice form. A non-zero vector $v \in \mathbb{Q}^3$ is called *Q-anisotropic* if $Q(v) \neq 0$. Since $\text{char } \mathbb{Q} \neq 2$, there exist such vectors, just suppose the contrary:

$$\begin{aligned}
Q(1, 0, 0) = 0 & \text{ gives } A_{11} = 0, \\
Q(0, 1, 0) = 0 & \text{ gives } A_{22} = 0, \\
Q(1, 1, 0) = 0 & \text{ gives } 2 \cdot A_{12} = 0
\end{aligned}$$

and A would be degenerate. In particular,

$$Q(1, \lambda, 0) = Q(1, 0, 0) + 2\lambda Q(1, 1, 0) + \lambda^2 Q(0, 1, 0)$$

will be different from zero for almost all $\lambda \in \mathbb{Q}$. Hence, we can assume that $(1, 0, 0)$ is anisotropic after applying a coordinate transformation of the form

$$x'_0 := x_0, \quad x'_1 := -\lambda x_0 + x_1, \quad x'_2 := x_2.$$

After another affine change of coordinates, we can also assume that A is a diagonal matrix. An inspection reveals that we can choose this coordinate transformation such that the x_0 -coordinate is left unaltered. (Just take for e_1 the anisotropic vector $(1, 0, 0)$ in the proof.) Such a transformation does not change the isomorphism type of X , and we can take X to be cut out by

an equation of the form

$$ax^2 + by^2 = 1 \quad \text{for } a, b \in \mathbb{Q}^\times$$

with affine coordinates $x := \frac{x_1}{x_0}$ and $y := \frac{x_2}{x_0}$. Since X is affine, the sheaves Ω_X^p are acyclic, hence we can compute its algebraic de Rham cohomology by

$$H_{\text{dR}}^\bullet(X) = H^\bullet(\Gamma(X, \Omega_X^\bullet)).$$

So we write down the complex $\Gamma(X, \Omega_X^\bullet)$ in detail

$$\begin{array}{c} 0 \\ \uparrow \\ \Gamma(X, \Omega_X^1) = \langle dx, dy \rangle_{\mathbb{Q}[x,y]/(ax^2+by^2-1)} / (axdx + bydy) \\ \uparrow \\ \Gamma(X, \mathcal{O}_X) = \mathbb{Q}[x, y]/(ax^2 + by^2 - 1). \end{array}$$

Obviously, $H_{\text{dR}}^1(X)$ is \mathbb{Q} -linearly generated by the elements $x^n y^m dx$ and $x^n y^m dy$ for $m, n \in \mathbb{N}_0$ modulo numerous relations. Using $axdx + bydy = 0$, we get

- $y^m dy = d \frac{y^{m+1}}{m+1} \sim 0$
- $x^n dx = d \frac{x^{n+1}}{n+1} \sim 0$
- $x^n y^m dy = \frac{-n}{m+1} x^{n-1} y^{m+1} dx + d \frac{x^n y^{m+1}}{m+1}$
 $\sim \frac{-n}{m+1} x^{n-1} y^{m+1} dx \quad \text{for } n \geq 1, m \geq 0$
- $x^n y^{2m} dx = x^n \left(\frac{1-ax^2}{b}\right)^m dx \sim 0$
- $x^n y^{2m+1} dx = x^n \left(\frac{1-ax^2}{b}\right)^m y dx$
- $xy dx = \frac{-x^2}{2} dy + d \frac{x^2 y}{2}$
 $\sim \frac{by^2-1}{2a} dy$
 $= \frac{b}{2a} y^2 dy - \frac{1}{2a} dy \sim 0$
- $(n \geq 2) x^n y dx = \frac{-b}{a} x^{n-1} y^2 dy + x^n y dx + \frac{b}{a} x^{n-1} y^2 dy$
 $= \frac{-b}{a} x^{n-1} y^2 dy + \frac{x^{n-1} y}{2a} d(ax^2 + by^2 - 1)$
 $= \frac{-b}{a} x^{n-1} y^2 dy + d \left(\frac{(x^{n-1} y)(ax^2 + by^2 - 1)}{2a} \right)$
 $\sim \frac{-b}{a} x^{n-1} y^2 dy$
 $= (x^{n+1} - \frac{x^{n-1}}{a}) dy$
 $= \left(-(n+1)x^n y + \frac{n-1}{a} x^{n-2} y \right) dx + d \left(x^{n+1} y - \frac{x^{n-1}}{a} y \right)$
- Hence $x^n y dx \sim \frac{n-1}{(n+2)a} x^{n-2} y dx \quad \text{for } n \geq 2.$

Thus we see that all generators are linearly dependent of $y dx$

$$H_{\text{dR}}^1(X) = H^1(\Gamma(X, \Omega_X^\bullet)) \cong \mathbb{Q} y dx.$$

What about the base change of X to \mathbb{C} ? We use the symbol $\sqrt{}$ for the principal branch of the square root. Over \mathbb{C} , the change of coordinates

$$u := \sqrt{ax} - i\sqrt{by}, \quad v := \sqrt{ax} + i\sqrt{by}$$

gives

$$\begin{aligned} X &= \operatorname{Spec}(\mathbb{C}[x, y]/(ax^2 + by^2 - 1)) \\ &= \operatorname{Spec}(\mathbb{C}[u, v]/(uv - 1)) \\ &= \operatorname{Spec}(\mathbb{C}[u, u^{-1}]) \\ &= \mathbb{A}_{\mathbb{C}}^1 \setminus \{0\}. \end{aligned}$$

Hence, the first singular homology group $H_{\bullet}^{\operatorname{sing}}(X, \mathbb{Q})$ of X is generated by

$$\sigma : [0, 1] \rightarrow X(\mathbb{C}), s \mapsto u = e^{2\pi i s},$$

i.e., a circle with radius 1 turning counter-clockwise around $u = 0$ once.

The period matrix consists of a single entry

$$\begin{aligned} \int_{\sigma} y dx &= \int_{\sigma} \frac{v-u}{2i\sqrt{b}} d \frac{u+v}{2\sqrt{a}} \\ &= \int_{\sigma} \frac{v du - u dv}{4i\sqrt{ab}} \\ &= \frac{1}{2i\sqrt{ab}} \int_{\sigma} \frac{du}{u} \\ &= \frac{\pi}{\sqrt{ab}}. \end{aligned}$$

The denominator squared is nothing but the *discriminant* of the quadratic form Q

$$\operatorname{disc} Q := \det A \in \mathbb{Q}^{\times}/(\mathbb{Q}^{\times})^2.$$

This is an important invariant, which distinguishes some, but not all isomorphism classes of quadratic forms. Since $\operatorname{disc} Q$ is well-defined modulo $(\mathbb{Q}^{\times})^2$, it makes sense to write

$$H_{\operatorname{dR}}^1(X) = \mathbb{Q} \frac{\pi}{\sqrt{\operatorname{disc} Q}} \subset H_{\operatorname{sing}}^1(X, \mathbb{Q}) \otimes_{\mathbb{Q}} \mathbb{C}.$$

14.4 Elliptic curves

In this section, we give another well-known example of a cohomological period in the sense of Chapter 11.

An *elliptic curve* E is a one-dimensional non-singular complete and connected group variety over a field k . Let O be the neutral element. This is a k -rational point. An elliptic curve has genus $g = 1$, where the genus g of a smooth projective curve C is defined as

$$g := \dim_k \Gamma(C, \Omega_C^1).$$

We refer to the book [Sil86] of Silverman for the theory of elliptic curves, but try to be self-contained in the following. For simplicity, we assume $k = \mathbb{Q}$. It can be shown, using the Riemann–Roch theorem, that such an elliptic curve E can be given as the zero locus in $\mathbb{P}^2(\mathbb{Q})$ of a Weierstraß equation

$$Y^2Z = 4X^3 - g_2XZ^2 - g_3Z^3 \quad (14.3)$$

with Eisenstein series coefficients $g_2 = 60G_4, g_3 = 140G_6$ and projective coordinates X, Y and Z .

By the classification of compact, oriented real surfaces, the base change of E to \mathbb{C} gives us a complex torus E^{an} , i.e., an isomorphism

$$E^{\text{an}} \cong \mathbb{C}/\Lambda_{\omega_1, \omega_2} \quad (14.4)$$

in the complex-analytic category with

$$\Lambda_{\omega_1, \omega_2} := \omega_1\mathbb{Z} \oplus \omega_2\mathbb{Z}$$

for $\omega_1, \omega_2 \in \mathbb{C}$ linearly independent over \mathbb{R} ,

being a lattice of full rank. Thus, all elliptic curves over \mathbb{C} are diffeomorphic to the standard torus $S^1 \times S^1$, but carry different complex structures as the parameter $\tau := \omega_2/\omega_1$ varies.

We can describe the isomorphism (14.4) quite explicitly using periods. Let α and β be a basis of

$$H_1^{\text{sing}}(E^{\text{an}}, \mathbb{Z}) \cong H_1^{\text{sing}}(S^1 \times S^1, \mathbb{Z}) \cong \mathbb{Z}\alpha \oplus \mathbb{Z}\beta.$$

The \mathbb{Q} -vector space $\Gamma(E, \Omega_E^1)$ is spanned by the algebraic differential form

$$\omega = \frac{dX}{Y}.$$

We can now choose ω_1 and ω_2 as

$$\omega_1 := \int_{\alpha} \omega \quad \text{and} \quad \omega_2 := \int_{\beta} \omega$$

as explicit generators of the lattice $\Lambda = \Lambda_{\omega_1, \omega_2}$. These numbers are also called the periods of E . The map

$$\begin{aligned}
E^{\text{an}} &\rightarrow \mathbb{C}/\Lambda_{\omega_1, \omega_2} \\
P &\mapsto \int_O^P \omega \text{ modulo } \Lambda_{\omega_1, \omega_2}
\end{aligned}
\tag{14.5}$$

then gives the isomorphism of Equation 14.4. Here $O = [0 : 1 : 0]$ denotes the group-theoretic origin in E .

The inverse map $\mathbb{C}/\Lambda_{\omega_1, \omega_2} \rightarrow E^{\text{an}}$ for the isomorphism (14.5) can be described in terms of the Weierstraß \wp -function of the lattice $\Lambda := \Lambda_{\omega_1, \omega_2}$, defined as

$$\wp(z) = \wp(z, \Lambda) := \frac{1}{z^2} + \sum_{\substack{\omega \in \Lambda \\ \omega \neq 0}} \left(\frac{1}{(z - \omega)^2} - \frac{1}{\omega^2} \right),$$

and takes the form

$$\begin{aligned}
\mathbb{C}/\Lambda_{\omega_1, \omega_2} &\rightarrow E^{\text{an}} \subset \mathbb{P}_{\mathbb{C}}^2 \\
z \text{ mod } \Lambda_{\omega_1, \omega_2} &\mapsto \begin{cases} [\wp(z) : \wp'(z) : 1] & z \notin \Lambda_{\omega_1, \omega_2}, \\ [0 : 1 : 0] & z \in \Lambda_{\omega_1, \omega_2}. \end{cases}
\end{aligned}$$

Note that under the natural projection $\pi : \mathbb{C} \rightarrow \mathbb{C}/\Lambda_{\omega_1, \omega_2}$ any meromorphic function f on the torus $\mathbb{C}/\Lambda_{\omega_1, \omega_2}$ lifts to a doubly-periodic function π^*f on the complex plane \mathbb{C} with periods ω_1 and ω_2

$$f(x + n\omega_1 + m\omega_2) = f(x) \quad \text{for all } n, m \in \mathbb{Z} \text{ and } x \in \mathbb{C}.$$

This example is possibly the origin of the “period” terminology.

The defining coefficients g_4, g_6 of E can be recovered from $\Lambda_{\omega_1, \omega_2}$ using the Eisenstein series

$$G_{2k} := \sum_{\substack{\omega \in \Lambda \\ \omega \neq 0}} \omega^{-2k} \quad \text{for } k = 2, 3$$

by setting $g_2 = 60G_4$ and $g_3 = 140G_6$. Therefore, the periods ω_1 and ω_2 determine the elliptic curve E uniquely. However, they are not invariants of E , since they depend on the chosen Weierstraß equation of E . A change of coordinates which preserves the shape of (14.3) must be of the form

$$X' = u^2 X, \quad Y' = u^3 Y, \quad Z' = Z \quad \text{for } u \in \mathbb{Q}^\times.$$

In the new parametrisation X', Y', Z' , we have

$$\begin{aligned}
G'_4 &= u^4 G_4, & G'_6 &= u^6 G_6, \\
\omega' &= u^{-1} \omega \\
\omega'_1 &= u^{-1} \omega_1 & \text{and } \omega'_2 &= u^{-1} \omega_2.
\end{aligned}$$

Hence, $\tau = \omega_2/\omega_1$ is a better invariant of the isomorphism class of E . The value of the j -function (a modular function)

$$j(\tau) = 1728 \frac{g_2^3}{g_2^3 - 27g_3^2} = q^{-1} + 744 + 196884q + \dots \quad (q = \exp(2\pi i\tau))$$

on τ indeed distinguishes non-isomorphic elliptic curves E over \mathbb{C} :

$$E \cong E' \text{ if and only if } j(E) = j(E').$$

Hence, the moduli space of elliptic curves over \mathbb{C} is the affine line.

A similar result holds over any algebraically closed field K of characteristic different from 2 or 3. For fields K that are not algebraically closed, the set of K -isomorphism classes of elliptic curves isomorphic over \bar{K} to a fixed curve E/K is the *Weil–Châtelet group* of E [Sil86], an infinite group for K a number field.

However, E has two more cohomological periods which are also called *quasi-periods*. In Section 14.5, we will prove that $\omega = \frac{dX}{Y}$ together with the meromorphic differential form

$$\eta := X \frac{dX}{Y}$$

spans $H_{\text{dR}}^1(E)$, i.e., modulo exact forms this form is a generator of $H^1(E, \mathcal{O}_E)$ in the Hodge decomposition. In the same way that ω corresponds to dz under (14.5), η corresponds to $\wp(z)dz$. The quasi-periods then are

$$\eta_1 := \int_{\alpha} \eta, \quad \eta_2 := \int_{\beta} \eta.$$

We obtain the following period matrix for E :

$$\begin{array}{c|cc} & \frac{dX}{Y} & X \frac{dX}{Y} \\ \alpha & \omega_1 & \eta_1 \\ \beta & \omega_2 & \eta_2 \end{array} \quad (14.6)$$

Lemma 14.4.1. *One has the Legendre relation*

$$\omega_1\eta_2 - \omega_2\eta_1 = \pm 2\pi i.$$

Remark 14.4.2. The sign in the statement corresponds to a choice (and order) of the basis $\{\alpha, \beta\}$ of $H_1^{\text{sing}}(E^{\text{an}}, \mathbb{Z})$, if we fix the basis $\{\frac{dX}{Y}, X \frac{dX}{Y}\}$ of $H_{\text{dR}}^1(E)$.

Proof. In this proof, we will define ω_i and η_i as above and choose α resp. β to correspond to the projection of the straight paths from a to $a + \omega_1$ resp. from a to $a + \omega_2$ for some $a \notin \Lambda$. Consider the Weierstraß ζ -function [Sil86, p. 166]

$$\zeta(z) := \frac{1}{z} + \sum_{\substack{\omega \in \Lambda \\ \omega \neq 0}} \left(\frac{1}{z-\omega} + \frac{1}{\omega} + \frac{z}{\omega^2} \right).$$

It satisfies $\zeta'(z) = -\wp(z)$. Since $\zeta'(z) = -\wp(z)$ and \wp is periodic, we have that the function $\eta(w) := \zeta(z) - \zeta(z+w)$ is independent of z . Even more, some values of this function are quasi-periods since

$$\eta_i = \int_a^{a+\omega_i} \eta = \int_a^{a+\omega_i} \wp(z) dz = - \int_a^{a+\omega_i} \zeta'(z) dz = \zeta(a) - \zeta(a+\omega_i) = \eta(\omega_i).$$

Note that our sign convention for $\eta(w)$ and our condition $\omega_2/\omega_1 \in \mathbb{H}$ both differ from the literature, e.g. from [Sil86, p. 166].

Using all this, the counter-clockwise path integral around the fundamental domain centered at some point $a \notin \Lambda_{\omega_1, \omega_2}$ yields

$$\begin{aligned} 2\pi i &= \int_a^{a+\omega_1} \zeta(z) dz + \int_{a+\omega_1}^{a+\omega_1+\omega_2} \zeta(z) dz - \int_{a+\omega_2}^{a+\omega_1+\omega_2} \zeta(z) dz - \int_a^{a+\omega_2} \zeta(z) dz \\ &= - \int_a^{a+\omega_2} (\zeta(z) - \zeta(z+\omega_1)) dz + \int_a^{a+\omega_1} (\zeta(z) - \zeta(z+\omega_2)) dz \\ &= \omega_1 \eta(\omega_2) - \omega_2 \eta(\omega_1) \\ &= \omega_1 \eta_2 - \omega_2 \eta_1. \end{aligned}$$

□

This is the second instance where we have shown that a determinant of a period matrix is a power of $2\pi i$ multiplied with a square root of a rational number. This was also pointed out by Kontsevich and Zagier, and a proof can be found in [Fre14].

In the following two examples, all four periods are calculated and yield Γ -values (including $\sqrt{\pi} = \Gamma(1/2)$), π and algebraic numbers. Such period expressions for elliptic curves with complex multiplication nowadays go by the name of *Chowla–Lerch–Selberg formula*, after Lerch [Ler97] and Chowla–Selberg [CS49]. See also the note of B. Gross [Gro79].

Example 14.4.3. Let E be the elliptic curve with $g_6 = 0$ and affine equation $Y^2 = 4X^3 - 4X$. The periods of this curve are [Wal08]

$$\omega_1 = 2 \int_1^\infty \frac{dx}{\sqrt{4x^3 - 4x}} = \int_1^\infty \frac{dx}{\sqrt{x^3 - x}} = \frac{1}{2} B\left(\frac{1}{4}, \frac{1}{2}\right) = \frac{\Gamma(1/4)^2}{2^{3/2} \pi^{1/2}}, \quad \omega_2 = i\omega_1,$$

using the Beta function and functional equations for the Γ function, and the quasi-periods are

$$\eta_1 = -\frac{\pi}{\omega_1} = -\frac{(2\pi)^{3/2}}{\Gamma(1/4)^2}, \quad \eta_2 = -i\eta_1.$$

E has complex multiplication with ring $\mathbb{Z}[i]$ (Gaussian integers).

Example 14.4.4. Look at the elliptic curve E with $g_4 = 0$ and affine equation $Y^2 = 4X^3 - 4$. Then one has periods [Wal08]

$$\omega_1 = 2 \int_1^\infty \frac{dx}{\sqrt{4x^3 - 4}} = \int_1^\infty \frac{dx}{\sqrt{x^3 - 1}} = \frac{1}{3} B\left(\frac{1}{6}, \frac{1}{2}\right) = \frac{\Gamma(1/3)^3}{24/3\pi}, \quad \omega_2 = \rho\omega_1,$$

where $\rho = \frac{-1+\sqrt{-3}}{2}$, and the quasi-periods are

$$\eta_1 = -\frac{2\pi}{\sqrt{3}\omega_1} = -\frac{2^{7/3}\pi^2}{3^{1/2}\Gamma(1/3)^3}, \quad \eta_2 = \rho^2\eta_1.$$

E has complex multiplication with ring $\mathbb{Z}[\rho]$ (Eisenstein numbers).

Both of these examples have complex multiplication. As we explained in Example 13.2.19, Chudnovsky [Chu80] has proved in agreement with Grothendieck's period conjecture that $\text{trdeg}_{\mathbb{Q}}\mathbb{P}(E) = 2$ if E is an elliptic curve with complex multiplication, as he could show for the entries of the period matrix that ω_1 and π are both transcendental and algebraically independent, and ω_2 , η_1 and η_2 are algebraically dependent. Of course, the transcendence of π is Lindemann's theorem. A combination of these arguments with Chudnovsky's results also gives that $\Gamma(1/3)$ and $\Gamma(1/4)$ are transcendental numbers, algebraically independent of π [Wal08]. The transcendence of ω_1 in these two examples also follows from a theorem of Th. Schneider [Sch35], see [Wal08]. Schneider showed more generally that any nonzero period of an elliptic integral of the first or the second kind with algebraic coefficients is transcendental, see Schneider's book [Sch57, Theorem 15, version III].

For elliptic curves without complex multiplication, it is conjectured that the Legendre relation is the only algebraic relation among the five period numbers ω_1 , ω_2 , η_1 , η_2 and π . But this is still open.

14.5 Periods of 1-forms on arbitrary curves

Let X be a smooth, projective curve of geometric genus g over k , where $k \subset \mathbb{C}$. We denote the associated analytic space by X^{an} .

In the classical literature, different types of meromorphic differential forms on X^{an} and their periods have been considered. The survey of Messing [Mes75] gives a historical account, see also [GH78, pg. 459]. In this section, we mention these notions, translate them into a modern language, and relate them to cohomological periods in the sense of Chapter 11, since the terminology is still used in many areas of mathematics, e.g., in transcendence theory.

A *meromorphic* 1-form ω on X^{an} is locally given by $f(z)dz$, where f is meromorphic. Any meromorphic function has poles in a discrete and finite

set D in X^{an} . Using a local coordinate z at a point $P \in X^{\text{an}}$, we can write $f(z) = z^{-\nu(P)} \cdot h(z)$, where h is holomorphic and $h(P) \neq 0$. In particular, a meromorphic 1-form is a section of the holomorphic line bundle $\Omega_{X^{\text{an}}}^1(kD)$ for some integer $k \geq 0$. We say that ω has *logarithmic poles*, if $\nu(P) \leq 1$ at all points of D . A *rational* 1-form is a section of the line bundle $\Omega_X^1(kD)$ on X . In particular, we can speak of rational 1-forms defined over k , if X is defined over k .

Proposition 14.5.1. *Meromorphic 1-forms on X^{an} are the same as rational 1-forms on X .*

Proof. Since X is projective, and meromorphic 1-forms are sections of the line bundle $\Omega_{X^{\text{an}}}^1(kD)$ for some integer $k \geq 0$, this follows from Serre's GAGA principle [Ser56]. \square

In the following, we will mostly use the analytic language of meromorphic forms.

Definition 14.5.2. A *differential of the first kind* on X^{an} is a holomorphic 1-form (hence closed). A *differential of the second kind* is a closed meromorphic 1-form with vanishing residues. A *differential of the third kind* is a closed meromorphic 1-form with at most logarithmic poles along some divisor $D^{\text{an}} \subset X^{\text{an}}$.

Note that forms of the second and third kind include forms of the first kind.

Theorem 14.5.3. *Any closed meromorphic 1-form ω on X^{an} can be written as*

$$\omega = df + \omega_1 + \omega_2 + \omega_3,$$

where df is an exact form, ω_1 is of the first kind, ω_2 is of the second kind, and ω_3 is of the third kind. In this decomposition, up to exact forms, ω_3 is unique up to forms of the first and second kind and ω_2 is unique up to forms of the first kind. The first de Rham cohomology of X^{an} is given by

$$H_{\text{dR}}^1(X^{\text{an}}, \mathbb{C}) \cong \frac{1 - \text{forms of the second kind}}{\text{exact forms}}.$$

The inclusion of differentials of the first kind into differentials of the second kind is given by the Hodge filtration

$$H^0(X^{\text{an}}, \Omega_{X^{\text{an}}}^1) \subset H_{\text{dR}}^1(X^{\text{an}}, \mathbb{C}).$$

For differentials of the third kind with poles along D^{an} , one has

$$\begin{aligned} F^1 H^1(X^{\text{an}} \setminus D^{\text{an}}, \mathbb{C}) &= H^0(X^{\text{an}}, \Omega_{X^{\text{an}}}^1 \langle D^{\text{an}} \rangle) \\ &\cong \frac{1 - \text{forms of the third kind with poles along } D^{\text{an}}}{\text{exact forms}}. \end{aligned}$$

Proof. Let ω be a closed meromorphic 1-form on X^{an} . The residue theorem states that the sum of the residues of ω is zero. Suppose that ω has poles in the finite subset $D^{\text{an}} \subset X^{\text{an}}$. Then look at the exact sequence

$$0 \rightarrow H^0(X^{\text{an}}, \Omega_{X^{\text{an}}}^1) \rightarrow H^0(X^{\text{an}}, \Omega_{X^{\text{an}}}^1 \langle D^{\text{an}} \rangle) \xrightarrow{\text{Res}} \bigoplus_{P \in D^{\text{an}}} \mathbb{C} \xrightarrow{\Sigma} H^1(X^{\text{an}}, \Omega_{X^{\text{an}}}^1).$$

This shows that there exists a 1-form $\omega_3 \in H^0(X^{\text{an}}, \Omega_{X^{\text{an}}}^1 \langle D^{\text{an}} \rangle)$ of the third kind which has the same residues as ω . The identification

$$F^1 H^1(X^{\text{an}} \setminus D^{\text{an}}, \mathbb{C}) = H^0(X^{\text{an}}, \Omega_{X^{\text{an}}}^1 \langle D^{\text{an}} \rangle)$$

is by definition of the Hodge filtration. In addition, the form $\omega - \omega_3$ is of the second kind, i.e., it has perhaps poles but no residues. Hence $\omega - \omega_3$ defines a form ω_2 of the second kind. All this is only unique up to a form ω_1 of the first kind and up to exact forms. This proves the decomposition. To prove the statement about the cohomology group $H_{\text{dR}}^1(X^{\text{an}}, \mathbb{C})$, we consider the meromorphic de Rham complex

$$\Omega_{X^{\text{an}}}^0(*) \xrightarrow{d} \Omega_{X^{\text{an}}}^1(*)$$

of all meromorphic differential forms on X^{an} with arbitrary poles along arbitrary divisors. The cohomology sheaves of it are given by [GH78, pg. 457]

$$\mathcal{H}^0 \Omega_{X^{\text{an}}}^\bullet(*) = \mathbb{C}, \quad \mathcal{H}^1 \Omega_{X^{\text{an}}}^\bullet(*) = \bigoplus_{P \in X^{\text{an}}} \mathbb{C}.$$

These isomorphisms are induced by the inclusion of constant functions and the residue map respectively. With the help of the spectral sequence abutting to $H^*(X^{\text{an}}, \Omega_{X^{\text{an}}}^\bullet(*))$ [GH78, pg. 458], one obtains an exact sequence

$$0 \rightarrow H_{\text{dR}}^1(X^{\text{an}}, \mathbb{C}) \rightarrow \frac{H^0(X^{\text{an}}, \Omega_{X^{\text{an}}}^1(*))}{\text{exact forms}} \xrightarrow{\text{Res}} \bigoplus_{P \in X^{\text{an}}} \mathbb{C},$$

and the claim about $H_{\text{dR}}^1(X^{\text{an}}, \mathbb{C})$ follows. □

Corollary 14.5.4. *In the algebraic category, if X is defined over $k \subset \mathbb{C}$, we have that*

$$H_{\text{dR}}^1(X) \cong \frac{\text{rational 1-forms of the second kind over } k}{\text{exact forms}}.$$

We can now define periods of differentials of the first, second, and third kind.

Definition 14.5.5. Periods of the n -th kind ($n=1,2,3$) are integrals of rational 1-forms of the n -th kind

$$\int_{\gamma} \omega,$$

where γ is a closed path avoiding the poles of ω for $n = 2$ and which is contained in $X \setminus D$ for $n = 3$.

In the literature, periods of 1-forms of the first kind are usually called periods, and periods of 1-forms of the second kind and not of the first kind are sometimes called *quasi-periods*.

Theorem 14.5.6. *Let X be a smooth, projective curve over k as above.*

Periods of the second kind (and hence also periods of the first kind) are cohomological periods in the sense of Definition 11.3.1 of the first cohomology group $H^1(X)$. Periods of the third kind with poles along D are periods of the cohomology group $H^1(U)$, where $U = X \setminus D$.

Every period of any smooth, quasi-projective curve U over k is of the first, second or third kind on a smooth compactification X of U .

Proof. The first assertion follows from the definition of periods of the n -th kind, since differentials of the n -th kind represent cohomology classes in $H^1(X)$ for $n = 1, 2$ and in $H^1(X \setminus D)$ for $n = 3$. If U is a smooth, quasi-projective curve over k , then we choose a smooth compactification X and the assertion follows from the exact sequence

$$0 \rightarrow H^0(X^{\text{an}}, \Omega_{X^{\text{an}}}^1) \rightarrow H^0(X^{\text{an}}, \Omega_{X^{\text{an}}}^1 \langle D \rangle) \xrightarrow{\text{Res}} \bigoplus_{P \in D} \mathbb{C} \xrightarrow{\Sigma} H^1(X^{\text{an}}, \Omega_{X^{\text{an}}}^1)$$

by Theorem 14.5.3. □

Examples 14.5.7. In the elliptic curve case of Section 14.4, $\omega = \frac{dX}{Y}$ is a 1-form of the first kind, and $\eta = X \frac{dX}{Y}$ a 1-form of the second kind, but not of the first kind. Some periods (and quasi-periods) of this sort were computed in the two Examples 14.4.3 and 14.4.4. An example of the third kind is given by $X = \mathbb{P}^1$ and $D = \{0, \infty\}$ where $\omega = \frac{dz}{z}$ is a generator with period $2\pi i$. Compare this with Section 14.1 where logarithms also occur as periods. For periods of differentials of the third kind on modular and elliptic curves, see [Bru13].

Finally, let X be a smooth, projective curve of genus g defined over \mathbb{Q} . Then there is a \mathbb{Q} -basis $\omega_1, \dots, \omega_g, \eta_1, \dots, \eta_g$ of $H_{\text{dR}}^1(X)$, where the ω_i are of the first kind and the η_j of the second kind. One may choose a basis $\alpha_1, \dots, \alpha_g, \beta_1, \dots, \beta_g$ for $H_1^{\text{sing}}(X^{\text{an}}, \mathbb{Z})$ such that, after a change of basis over \mathbb{Q} , we have $\int_{\alpha_j} \omega_i = \delta_{ij}$ and $\int_{\beta_j} \eta_i = \delta_{ij}$.

The period matrix is then given by a block matrix:

$$\begin{array}{c|cc} & \omega_{\bullet} & \eta_{\bullet} \\ \alpha_{\bullet} & \mathbb{I} & \tau' \\ \beta_{\bullet} & \tau & \mathbb{I} \end{array} \tag{14.7}$$

where, by *Riemann's bilinear relations* [GH78, pg. 123], τ is a matrix in the *Siegel upper half space* \mathbb{H}_g of symmetric complex matrices with positive definite imaginary part. In the example of elliptic curves of Section 14.4, the matrix τ is the (1×1) -matrix given by $\tau = \omega_2/\omega_1 \in \mathbb{H}$.

For transcendence results for periods of curves and abelian varieties, we refer to the survey of Wüstholz [Wüs12], and our discussion in Section 13.2 of Part III.

Chapter 15

Multiple zeta values

This chapter partly follows the Diploma thesis of Benjamin Friedrich, see [Fri04]. We study in some detail the very important class of periods called *multiple zeta values* (MZV). These are periods of mixed Tate motives, which we discussed in Section 6.4. Multiple zeta values are in fact periods of unramified mixed Tate motives, a full subcategory of all mixed Tate motives. A general reference for all aspects of multiple zeta values is [BGF].

We first explain the representation of multiple zeta values as period integrals due to Kontsevich. Then we discuss some of their algebraic properties and mention the work of Francis Brown and others, showing that multiple zeta values are precisely the periods of unramified mixed Tate motives. We also sketch the relation between multiple zeta values and periods of moduli spaces of marked curves. Finally, we discuss an example of a variation of mixed Tate motives in a family, and compute the degeneration of Hodge structures in the limit. Periods as functions of parameters in the case of families of algebraic varieties become interesting special functions, called (*multiple*) *polylogarithms*. Many questions about multiple zeta values and (multiple) polylogarithms are still open, in particular about their transcendence properties. This is strongly connected to Grothendieck's period conjecture. We start with the simplest and classical example of $\zeta(2)$.

15.1 A ζ -value, the basic example

In Prop. 12.1.7, we saw how to write $\zeta(2)$ as a Kontsevich–Zagier period:

$$\zeta(2) = \int_{0 \leq x \leq y \leq 1} \frac{dx \wedge dy}{(1-x)y}.$$

The problem was that this identity did not give us a valid representation of $\zeta(2)$ as a naive period, since the pole locus of the integrand and the domain

of integration are not disjoint. We show how to circumvent this difficulty, as an example of Theorem 12.2.1.

First we define (often ignoring the difference between X and X^{an}),

$$\begin{aligned} Y &:= \mathbb{A}^2 \quad \text{with coordinates } x \text{ and } y, \\ Z &:= \{x = 1\} \cup \{y = 0\}, \\ X &:= Y \setminus Z, \\ D &:= (\{x = 0\} \cup \{y = 1\} \cup \{x = y\}) \setminus Z, \\ \Delta &:= \{(x, y) \in Y \mid x, y \in \mathbb{R}, 0 \leq x \leq y \leq 1\} \quad \text{a triangle in } Y, \quad \text{and} \\ \omega &:= \frac{dx \wedge dy}{(1-x)y}, \end{aligned}$$

thus getting

$$\zeta(2) = \int_{\Delta} \omega,$$

with $\omega \in \Gamma(X, \Omega_X^2)$ and $\partial\Delta \subset D \cup \{(0, 0), (1, 1)\}$, see Figure 15.1.

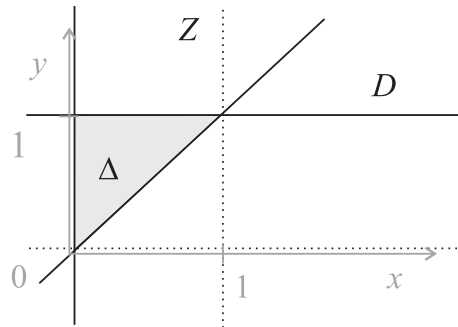

Fig. 15.1 The configuration Z, D, Δ

Now we blow up Y at the points $(0, 0)$ and $(1, 1)$ obtaining $\pi : \tilde{Y} \rightarrow Y$. We denote the strict transform of Z by \tilde{Z} , $\pi^*\omega$ by $\tilde{\omega}$ and $\tilde{Y} \setminus \tilde{Z}$ by \tilde{X} . The “strict transform” $\pi^{-1}(\Delta \setminus \{(0, 0), (1, 1)\})$ will be called $\tilde{\Delta}$ and (being \mathbb{Q} -semi-algebraic hence triangulable — cf. Proposition 2.6.10) gives rise to a singular chain

$$\tilde{\gamma} \in H_2^{\text{sing}}(\tilde{X}, \tilde{D}; \mathbb{Q}).$$

Since π is an isomorphism away from the exceptional locus, this exhibits

$$\zeta(2) = \int_{\Delta} \omega = \int_{\tilde{\Delta}} \tilde{\omega} \in \mathbb{P}_{\text{nv}} = \mathbb{P}$$

as a naive period, see Figure 15.2.

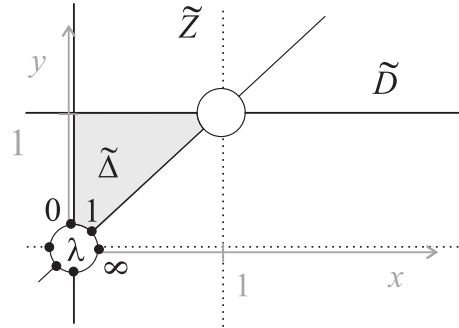

Fig. 15.2 The configuration $\tilde{Z}, \tilde{D}, \tilde{\Delta}$

We will conclude this example by writing out $\tilde{\omega}$ and $\tilde{\Delta}$ more explicitly. Note that \tilde{Y} can be described as the subvariety

$$\mathbb{A}_{\mathbb{Q}}^2 \times \mathbb{P}^1(\mathbb{Q}) \times \mathbb{P}^1(\mathbb{Q}) \quad \text{with coordinates} \quad (\tilde{x}, \tilde{y}, [\lambda_0 : \lambda_1], [\mu_0 : \mu_1])$$

cut out by

$$\tilde{x}\lambda_0 = \tilde{y}\lambda_1 \quad \text{and} \quad (\tilde{x} - 1)\mu_0 = (\tilde{y} - 1)\mu_1.$$

With this choice of coordinates π takes the form

$$\begin{aligned} \pi : \quad \tilde{Y} &\rightarrow Y \\ (\tilde{x}, \tilde{y}, [\lambda_0 : \lambda_1], [\mu_0 : \mu_1]) &\mapsto (\tilde{x}, \tilde{y}) \end{aligned}$$

and we have $\tilde{X} := \tilde{Y} \setminus (\{\lambda_0 = 0\} \cup \{\mu_1 = 0\})$. We can embed \tilde{X} into affine space

$$\begin{aligned} \tilde{X} &\rightarrow \mathbb{A}_{\mathbb{Q}}^4 \\ (\tilde{x}, \tilde{y}, \lambda_0 : \lambda_1, \mu_0 : \mu_1) &\mapsto (\tilde{x}, \tilde{y}, \frac{\lambda_1}{\lambda_0}, \frac{\mu_0}{\mu_1}) \end{aligned}$$

and so have affine coordinates $\tilde{x}, \tilde{y}, \lambda := \frac{\lambda_1}{\lambda_0}$ and $\mu := \frac{\mu_0}{\mu_1}$ on \tilde{X} .

Now, near $\pi^{-1}(0, 0)$, the form $\tilde{\omega}$ is given by

$$\tilde{\omega} = \frac{d\tilde{x} \wedge d\tilde{y}}{(1 - \tilde{x})\tilde{y}} = \frac{d(\lambda\tilde{y}) \wedge d\tilde{y}}{(1 - \tilde{x})\tilde{y}} = \frac{d\lambda \wedge d\tilde{y}}{1 - \tilde{x}},$$

while near $\pi^{-1}(1, 1)$ we have

$$\tilde{\omega} = \frac{d\tilde{x} \wedge d\tilde{y}}{(1 - \tilde{x})\tilde{y}} = \frac{d\tilde{x} \wedge d(\tilde{y} - 1)}{(1 - \tilde{x})\tilde{y}} = \frac{d\tilde{x} \wedge d(\mu(\tilde{x} - 1))}{(1 - \tilde{x})\tilde{y}} = \frac{-d\tilde{x} \wedge d\mu}{\tilde{y}}.$$

The region $\tilde{\Delta}$ is given by

$$\tilde{\Delta} = \{(\tilde{x}, \tilde{y}, \lambda, \mu) \in \tilde{X}(\mathbb{C}) \mid \tilde{x}, \tilde{y}, \lambda, \mu \in \mathbb{R}, 0 \leq \tilde{x} \leq \tilde{y} \leq 1, 0 \leq \lambda \leq 1, 0 \leq \mu \leq 1\}.$$

15.2 Definition of multiple zeta values

Recall that the Riemann ζ -function is defined as

$$\zeta(s) := \sum_{n=1}^{\infty} n^{-s}, \quad \operatorname{Re}(s) > 1.$$

It has an analytic continuation to the whole complex plane with a simple pole at $s = 1$.

Definition 15.2.1. For integers $s_1, \dots, s_r \geq 1$ with $s_1 \geq 2$ one defines the *multiple zeta values* (MZV)

$$\zeta(s_1, \dots, s_r) := \sum_{n_1 > n_2 > \dots > n_r \geq 1} n_1^{-s_1} \cdots n_r^{-s_r}.$$

The number $n = s_1 + \dots + s_r$ is the *weight* of $\zeta(s_1, \dots, s_r)$. The *length* is r .

Lemma 15.2.2. $\zeta(s_1, \dots, s_r)$ is convergent.

Proof. Clearly, $\zeta(s_1, \dots, s_r) \leq \zeta(2, 1, \dots, 1)$. We use the formula

$$\sum_{n=1}^{m-1} n^{-1} \leq 1 + \log(m-1),$$

which is proved by comparing with the Riemann integral of $1/x$. This implies that

$$\zeta(2, 1, \dots, 1) \leq \sum_{n_1=1}^{\infty} n_1^{-2} \sum_{1 \leq n_r < \dots < n_2 \leq n_1-1} n_2^{-1} \cdots n_r^{-1} \leq \sum_{n_1=1}^{\infty} \frac{(1 + \log(n_1 - 1))^r}{n_1^2},$$

which is convergent. \square

Lemma 15.2.3. The positive even ζ -values are given by

$$\zeta(2m) = (-1)^{m+1} \frac{(2\pi)^{2m}}{2(2m)!} B_{2m},$$

where B_{2m} is a Bernoulli number, defined via

$$\frac{t}{e^t - 1} = \sum_{m=0}^{\infty} B_m \frac{t^m}{m!}.$$

The first Bernoulli numbers are $B_0 = 1$, $B_1 = -1/2$, $B_2 = 1/6$, $B_3 = 0$, $B_4 = -1/30$. All Bernoulli B_m numbers vanish for odd $m \geq 3$.

Proof. One uses the power series

$$x \cot(x) = 1 - 2 \sum_{n=1}^{\infty} \frac{x^2}{n^2 \pi^2 - x^2}.$$

The geometric series expansion gives

$$x \cot(x) = 1 - 2 \sum_{n=1}^{\infty} \frac{\left(\frac{x}{n\pi}\right)^2}{1 - \left(\frac{x}{n\pi}\right)^2} = 1 - 2 \sum_{m=1}^{\infty} \frac{x^{2m}}{\pi^{2m}} \zeta(2m).$$

On the other hand,

$$x \cot(x) = ix \frac{e^{ix} + e^{-ix}}{e^{ix} - e^{-ix}} = ix \frac{e^{2ix} + 1}{e^{2ix} - 1} = ix + \frac{2ix}{e^{2ix} - 1} = ix + \sum_{m=0}^{\infty} B_m \frac{(2ix)^m}{m!}.$$

The claim then follows by comparing coefficients. \square

Corollary 15.2.4. For $m = 1$ and $m = 2$, one immediately gets $\zeta(2) = \frac{\pi^2}{6}$ and $\zeta(4) = \frac{\pi^4}{90}$.

$\zeta(s)$ satisfies a functional equation

$$\zeta(s) = 2^s \pi^{s-1} \sin\left(\frac{\pi s}{2}\right) \Gamma(1-s) \zeta(1-s).$$

Using this, one can show:

Corollary 15.2.5. $\zeta(-m) = -\frac{B_{m+1}}{m+1}$ for $m \geq 0$. In particular, $\zeta(-2m) = 0$ for $m \geq 1$. These are called the trivial zeroes of $\zeta(s)$.

Remark 15.2.6. J. Zhao has generalised the analytic continuation and the functional equation for meromorphic functions corresponding to multiple zeta values [Zha00].

In the following sections, we want to further study multiple zeta values as periods. They satisfy many relations. Euler already knew that $\zeta(2, 1) = \zeta(3)$. This can be shown as follows:

$$\begin{aligned}
\zeta(3) + \zeta(2, 1) &= \sum_{n=1}^{\infty} \frac{1}{n^3} + \sum_{1 \leq k < n} \frac{1}{n^2 k} = \sum_{1 \leq k \leq n} \frac{1}{n^2 k} = \sum_{n=1}^{\infty} \frac{1}{n^2} \sum_{k=1}^n \frac{1}{k} \\
&= \sum_{k, n \geq 1} \frac{1}{n^2} \left(\frac{1}{k} - \frac{1}{n+k} \right) = \sum_{k, n \geq 1} \frac{1}{nk(n+k)} \\
&= \sum_{k, n \geq 1} \left(\frac{1}{n} + \frac{1}{k} \right) \frac{1}{(n+k)^2} = \sum_{k, n \geq 1} \frac{1}{n(n+k)^2} + \sum_{k, n \geq 1} \frac{1}{k(n+k)^2} \\
&= 2\zeta(2, 1).
\end{aligned}$$

Other relations of this type are

$$\begin{aligned}
\zeta(2, 1, 1) &= \zeta(4), \\
\zeta(2, 2) &= \frac{3}{4}\zeta(4), \\
\zeta(3, 1) &= \frac{1}{4}\zeta(4), \\
\zeta(2)^2 &= \frac{5}{2}\zeta(4), \\
\zeta(5) &= \zeta(3, 1, 1) + \zeta(2, 1, 2) + \zeta(2, 2, 1) \\
\zeta(5) &= \zeta(4, 1) + \zeta(3, 2) + \zeta(2, 3).
\end{aligned}$$

The last two relations are special cases of the *sum relation*:

$$\zeta(n) = \sum_{s_1 + \dots + s_r = n} \zeta(s_1, \dots, s_r).$$

We will see more such relations, after we have studied other properties of multiple zeta values.

15.3 Kontsevich's integral representation

Define 1-forms $\omega_0 := \frac{dt}{t}$ and $\omega_1 := \frac{dt}{1-t}$. We have seen that

$$\zeta(2) = \int_{0 \leq t_1 \leq t_2 \leq 1} \omega_0(t_2) \omega_1(t_1).$$

In a similar way, we get that

$$\zeta(n) = \int_{0 \leq t_1 \leq \dots \leq t_n \leq 1} \omega_0(t_n) \omega_0(t_{n-1}) \cdots \omega_1(t_1).$$

We will now write this as

$$\zeta(n) = I(\underbrace{0\dots 01}_n).$$

Definition 15.3.1. For $\epsilon_1, \dots, \epsilon_n \in \{0, 1\}$, we define the Kontsevich–Zagier periods

$$I(\epsilon_n \dots \epsilon_1) := \int_{0 \leq t_1 \leq \dots \leq t_n \leq 1} \omega_{\epsilon_n}(t_n) \omega_{\epsilon_{n-1}}(t_{n-1}) \cdots \omega_{\epsilon_1}(t_1).$$

In this generality, the integrals do not converge for some choices of ϵ_i . They do if the string $\epsilon_1, \dots, \epsilon_n$ starts with a 0 and ends with a 1. In all cases where there is some numerical evaluation, we assume tacitly that the parameters are chosen such that convergence holds. Note that this definition differs from parts of the literature in terms of the order, since there are two canonical choices. One has the following important formula:

Theorem 15.3.2 (Attributed to Kontsevich by Zagier [Zag94]).

$$\zeta(s_1, \dots, s_r) = I(\underbrace{0\dots 01}_{s_1} \underbrace{0\dots 01}_{s_2} \dots \underbrace{0\dots 01}_{s_r}).$$

In particular, the convergent MZV (i.e., the ones with $s_1 \geq 2$) are Kontsevich–Zagier periods.

Proof. For the proof we define more generally

$$I(0; \epsilon_n \dots \epsilon_1; z) := \int_{0 \leq t_1 \leq \dots \leq t_n \leq z} \omega_{\epsilon_n}(t_n) \omega_{\epsilon_{n-1}}(t_{n-1}) \cdots \omega_{\epsilon_1}(t_1)$$

for $0 \leq z \leq 1$. Then we show that

$$I(0; \underbrace{0\dots 01}_{s_1} \underbrace{0\dots 01}_{s_2} \dots \underbrace{0\dots 01}_{s_r}; z) = \sum_{n_1 > n_2 > \dots > n_r \geq 1} \frac{z^{n_1}}{n_1^{s_1} \cdots n_r^{s_r}}.$$

Convergence clearly always holds for $z < 1$, but it will extend to $z = 1$ by Abel's theorem. We proceed by induction on $n = \sum_{i=1}^r s_i$. We start with $n = 1$:

$$I(0; 1; z) = \int_0^z \omega_1(t) = \int_0^z \sum_{n \geq 0} t^n dt = \sum_{n \geq 0} \frac{z^{n+1}}{n+1} = \sum_{n \geq 1} \frac{z^n}{n}.$$

The induction step has two cases:

$$\begin{aligned} I(0; 0 \underbrace{0\dots 01}_{s_1} \underbrace{0\dots 01}_{s_2} \dots \underbrace{0\dots 01}_{s_r}; z) &= \int_0^z \frac{dt_n}{t_n} I(0; \underbrace{0\dots 01}_{s_1} \underbrace{0\dots 01}_{s_2} \dots \underbrace{0\dots 01}_{s_r}; t_n) \\ &= \int_0^z \frac{dt_n}{t_n} \sum_{n_1 > n_2 > \dots > n_r \geq 1} \frac{t_n^{n_1}}{n_1^{s_1} \cdots n_r^{s_r}} = \sum_{n_1 > n_2 > \dots > n_r \geq 1} \frac{z^{n_1}}{n_1^{s_1+1} \cdots n_r^{s_r}}. \end{aligned}$$

$$\begin{aligned}
 & I(0; 1 \underbrace{0 \dots 01}_{s_1} \underbrace{0 \dots 01}_{s_2} \dots \underbrace{0 \dots 01}_{s_r}; z) \\
 &= \int_0^z \frac{dt_n}{1-t_n} I(0; \underbrace{0 \dots 01}_{s_1} \underbrace{0 \dots 01}_{s_2} \dots \underbrace{0 \dots 01}_{s_r}; t_n) \\
 &= \int_0^z dt_n \sum_{m=0}^{\infty} t_n^m \sum_{n_1 > n_2 > \dots > n_r \geq 1} \frac{t_n^{n_1}}{n_1^{s_1} \dots n_r^{s_r}} \\
 &= \sum_{m=0}^{\infty} \sum_{n_1 > n_2 > \dots > n_r \geq 1} \int_0^z dt_n \frac{t_n^{n_1+m}}{n_1^{s_1} \dots n_r^{s_r}} \\
 &= \sum_{n_0 > n_1 > n_2 > \dots > n_r \geq 1} \frac{z^{n_0}}{n_1^{s_1} \dots n_r^{s_r}}.
 \end{aligned}$$

In the latter step we strictly use $z < 1$ to have convergence. It does not occur at the end of the induction, since the string starts with a 0. Convergence is finally proven by Abel’s theorem in the last step. \square

15.4 Relations among multiple zeta values

In this section, we present a slightly more abstract viewpoint on multiple zeta values and their relations by looking only at the strings representing a MZV integral. It turns out that there are two types of multiplications on those strings, called the shuffle and stuffle products, which induce the usual multiplication on the integrals, but which have a different definition. Comparing both leads to all kind of relations between multiple zeta values. The reader may also consult [BGF, IKZ06, Hof97, HO03, Hen12] for more information.

In the literature, the shuffle and stuffle relations are an important tool, especially in the more computationally oriented physics literature, since they resemble the Hopf algebra structure which is behind everything.

A MZV can be represented via a tuple (s_1, \dots, s_r) of integers or a string

$$s = \underbrace{0 \dots 01}_{s_1} \underbrace{0 \dots 01}_{s_2} \dots \underbrace{0 \dots 01}_{s_r}$$

of 0’s and 1’s. There is a one-to-one correspondence between strings with a 0 on the left and a 1 on the right and all tuples (s_1, \dots, s_r) with all $s_i \geq 1$ and $s_1 \geq 2$. Such strings are called *admissible*. For any tuple $s = (s_1, \dots, s_r)$, we denote the associated string by \tilde{s} . We will formalise the algebras arising from this set-up.

Definition 15.4.1 (Hoffman algebra). Let

$$\mathfrak{h} := \mathbb{Q}\langle x, y \rangle = \mathbb{Q} \oplus \mathbb{Q}x \oplus \mathbb{Q}y \oplus \mathbb{Q}xy \oplus \mathbb{Q}yx \oplus \cdots$$

be the free non-commutative graded algebra in two variables x, y (both of degree 1). There are subalgebras

$$\mathfrak{h}^1 := \mathbb{Q} \oplus \mathfrak{h}y, \quad \mathfrak{h}^0 := \mathbb{Q} \oplus x\mathfrak{h}y.$$

The generator in degree 0 is denoted by \mathbb{I} .

We will now identify x and y with 0 and 1, if it is convenient. For example, any generator, i.e., a non-commutative word in x and y of length n , can be viewed as a string $\epsilon_n \cdots \epsilon_1$ in the letters 0 and 1. With this identification, the generators of \mathfrak{h}^0 consist of admissible strings and there is obviously an evaluation map $\zeta : \mathfrak{h}^0 \rightarrow \mathbb{R}$ such that

$$\zeta(\epsilon_n \cdots \epsilon_1) = I(\epsilon_n, \dots, \epsilon_1)$$

holds on the generators of \mathfrak{h}^0 . In addition, if s is the string

$$s = \epsilon_n \cdots \epsilon_1 = \underbrace{0 \dots 01}_{s_1} \underbrace{0 \dots 01}_{s_2} \dots \underbrace{0 \dots 01}_{s_r},$$

then we have $\zeta(s_1, \dots, s_r) = \zeta(s)$ by Theorem 15.3.2.

We will now define two different multiplications

$$\text{III}, * : \mathfrak{h} \times \mathfrak{h} \rightarrow \mathfrak{h},$$

called *shuffle* and *shuffle product*, such that ζ becomes a ring homomorphism when restricted to \mathfrak{h}^0 in both cases.

Definition 15.4.2. Define the *shuffle permutations* for $r + s = n$ as

$$\Sigma_{r,s} := \{\sigma \in \Sigma_n \mid \sigma(1) < \sigma(2) < \cdots < \sigma(r), \sigma(r+1) < \sigma(r+2) < \cdots < \sigma(r+s)\}.$$

Define the action of $\sigma \in \Sigma_{r,s}$ on the set $\{1, 2, \dots, n\}$ as

$$\sigma(x_1 \dots x_n) := x_{\sigma^{-1}(1)} \dots x_{\sigma^{-1}(n)}.$$

The *shuffle product* is then defined as

$$x_1 \dots x_r \text{III} x_{r+1} \dots x_n := \sum_{\sigma \in \Sigma_{r,s}} \sigma(x_1 \dots x_n).$$

Theorem 15.4.3. *The shuffle product III defines an associative, bilinear operation with unit \mathbb{I} and hence an algebra structure on \mathfrak{h} such that after restriction to \mathfrak{h}^0 , ζ becomes a ring homomorphism. It satisfies the recursive*

formula

$$u\text{III}v = a(u'\text{III}v) + b(u\text{III}v'),$$

if $u = au'$ and $v = bv'$ as strings.

Proof. We only prove that ζ is a ring homomorphism on \mathfrak{h}^0 , the rest is straightforward. Assume $a = (a_1, \dots, a_r)$ is of weight m and $b = (b_1, \dots, b_s)$ is of weight n . Denote by \tilde{a} and \tilde{b} the associated admissible strings. We want to prove the product formula

$$\zeta(\tilde{a}\text{III}\tilde{b}) = \zeta(a)\zeta(b).$$

By Fubini, the product $\zeta(a)\zeta(b)$ is an integral over the product domain

$$\Delta = \{0 \leq t_1 \leq \dots \leq t_m \leq 1\} \times \{0 \leq t_{m+1} \leq \dots \leq t_{m+n} \leq 1\}.$$

Ignoring subsets of measure zero,

$$\Delta = \coprod_{\sigma} \Delta_{\sigma}$$

indexed by all shuffles $\sigma \in \Sigma_{r,s}$, and where

$$\Delta_{\sigma} = \{(t_1, \dots, t_{m+s}) \mid 0 \leq t_{\sigma^{-1}(1)} \leq \dots \leq t_{\sigma^{-1}(n)} \leq 1\}.$$

The proof then follows from the additivity of the integral. \square

This induces binary relations as in the following examples.

Example 15.4.4. One has

$$(01)\text{III}(01) = 2(0101) + 4(0011)$$

and hence we have

$$\zeta(2)^2 = 2\zeta(2, 2) + 4\zeta(3, 1).$$

In a similar way,

$$(01)\text{III}(001) = (010011) + 3(001011) + 9(000111) + (001101),$$

which implies that

$$\zeta(2)\zeta(3, 1) = \zeta(2, 3, 1) + 3\zeta(3, 2, 1) + 9\zeta(4, 1, 1) + \zeta(3, 1, 2),$$

and

$$(01)\text{III}(011) = 3(01011) + 6(00111) + (01101)$$

implies that

$$\zeta(2)\zeta(2, 1) = 3\zeta(2, 2, 1) + 6\zeta(3, 1, 1) + \zeta(2, 1, 2).$$

Definition 15.4.5. The *stuffle product*

$$* : \mathfrak{h} \times \mathfrak{h} \longrightarrow \mathfrak{h}$$

is defined on tuples $a = (a_1, \dots, a_r)$ and $b = (b_1, \dots, b_s)$ as

$$\begin{aligned} a * b : &= (a_1, \dots, a_r, b_1, \dots, b_s) + (a_1, \dots, a_r + b_1, \dots, b_s) \\ &+ (a_1, \dots, a_{r-1}, b_1, a_r, b_2, \dots, b_s) + (a_1, \dots, a_{r-1} + b_1, a_r, b_2, \dots, b_s) + \dots \end{aligned}$$

Here, the dots \dots mean that one continues in the same way as in the first three steps by sliding the a -variables from the left to the right into the b -variables, and adding in the case of a collision. See [BGF, Def. 1.98] for a recursive definition.

The definition is made so that one has the formula $\zeta(a)\zeta(b) = \zeta(a * b)$:

Theorem 15.4.6. *The stuffle product $*$ defines an associative, bilinear multiplication on \mathfrak{h} inducing an algebra $(\mathfrak{h}, *)$ with unit $\mathbb{1}$. One has $\zeta(a)\zeta(b) = \zeta(a * b)$ on tuples a and b in \mathfrak{h}^0 . Furthermore, there is a recursion formula*

$$u * v = (a, u' * v) + (b, u * v') + (a, b, u' * v')$$

for tuples $u = (a, u')$ and $v = (b, v')$ with first entry a and b .

Proof. Again, we only give a proof for the product formula $\zeta(a)\zeta(b) = \zeta(a * b)$. Assume $a = (a_1, \dots, a_r)$ is of weight m and $b = (a_{r+1}, \dots, a_{r+s})$ is of weight n . The claim follows from a decomposition of the summation range:

$$\begin{aligned} &\zeta(a_1, \dots, a_r)\zeta(a_{r+1}, \dots, a_{r+s}) \\ &= \sum_{n_1 > n_2 > \dots > n_r \geq 1} n_1^{-a_1} \dots n_r^{-a_r} \cdot \sum_{n_{r+1} > n_{r+2} > \dots > n_{r+s} \geq 1} n_{r+1}^{-a_{r+1}} \dots n_{r+s}^{-a_{r+s}} = \\ &= \sum_{n_1 > n_2 > \dots > n_r > n_{r+1} > n_{r+2} > \dots > n_{r+s} \geq 1} n_1^{-a_1} \dots n_r^{-a_r} n_{r+1}^{-a_{r+1}} \dots n_{r+s}^{-a_{r+s}} \\ &+ \sum_{n_1 > n_2 > \dots > n_r = n_{r+1} > n_{r+2} > \dots > n_{r+s} \geq 1} n_1^{-a_1} \dots n_r^{-(a_r + a_{r+1})} \dots n_{r+s}^{-a_{r+s}} \\ &+ \text{etc.} \end{aligned}$$

where all terms in the stuffle set occur once. \square

This again induces binary relations as in the following examples.

Example 15.4.7.

$$\begin{aligned} \zeta(2)\zeta(3, 1) &= \zeta(2, 3, 1) + \zeta(5, 1) + \zeta(3, 2, 1) + \zeta(3, 3) + \zeta(3, 1, 2) \\ \zeta(2)^2 &= 2\zeta(2, 2) + \zeta(4). \end{aligned}$$

More generally,

$$\zeta(a)\zeta(b) = \zeta(a, b) + \zeta(a + b) + \zeta(b, a), \text{ for } a, b \geq 2.$$

Since we have $\zeta(\tilde{a}\text{III}\tilde{b}) = \zeta(a * b)$, we can define the unary double-shuffle relation as

$$\zeta(\tilde{a}\text{III}\tilde{b} - a * b) = 0.$$

Example 15.4.8. We have $\zeta(2)^2 = 2\zeta(2, 2) + 4\zeta(3, 1)$ using the shuffle and $\zeta(2)^2 = 2\zeta(2, 2) + \zeta(4)$ using the stuffle. Therefore one has

$$4\zeta(3, 1) = \zeta(4).$$

In the literature [Hof97, HO03, IKZ06, Hen12] more relations have been found, e.g., a modified version of this relation, called the *regularised double-shuffle relation*:

$$\zeta \left(\sum_{b \in (1)*a} b - \sum_{\tilde{c} \in (1)\text{III}\tilde{a}} c \right) = 0.$$

Example 15.4.9. Let $a = \widetilde{(2)} = (01)$. Then $(1)\text{III}(01) = (101) + 2(011)$ and $(1) * (2) = (1, 2) + (3) + (2, 1)$. Therefore, the corresponding relation is

$$\zeta(1, 2) + 2\zeta(2, 1) = \zeta(1, 2) + \zeta(3) + \zeta(2, 1), \text{ hence}$$

$$\zeta(2, 1) = \zeta(3).$$

Like in this example, it is always the case that all non-convergent contributions cancel in the relation, since they occur with the same multiplicity in both expressions. It is conjectured that the regularised double-shuffle relation generates all relations among MZV. There are more relations: the sum theorem (mentioned above), the duality theorem, the derivation theorem and Ohno's theorem, which implies the first three [HO03, Hen12].

The above discussion about the search for relations between MZVs raises the question about the dimension of the spaces of MZV of a given weight. It was conjectured by Zagier [Zag94] that the \mathbb{Q} -vector space Z_n of MZV of weight n has dimension d_n , where d_n is the coefficient of t^n in the power series

$$\sum_{n=0}^{\infty} d_n t^n = \frac{1}{1 - t^2 - t^3},$$

so that one has a recursion $d_n = d_{n-2} + d_{n-3}$. For example $d_4 = 1$, which can be checked using the above relations. The fact that $d_0 = 1$ is compatible with the convention that the MZV of weight 0 form a constant summand \mathbb{Q} . This conjecture is still open, however it is known that d_n is an upper bound for $\dim_{\mathbb{Q}}(Z_n)$ [Bro12, DG05, Ter02]. It is also conjectured that the MZV of different weights are independent over \mathbb{Q} , so that the space of all MZV should be a direct sum

$$Z = \bigoplus_{n \geq 0} Z_n.$$

The direct sum decomposition would imply immediately that all $\zeta(n)$ ($n \geq 2$) are transcendental.

Hoffman [Hof97] conjectured that all MZV containing only $s_i \in \{2, 3\}$ form a basis of Z . Brown [Bro12] showed in 2010 that this set forms a generating set. Broadhurst et. al. [BBV10] conjecture that the $\zeta(s_1, \dots, s_r)$ with $s_i \in \{2, 3\}$ a so-called *Lyndon word* form a transcendence basis. A Lyndon word in two letters with an order, e.g. $2 < 3$, is a word w such that for all non-trivial decompositions $w = uv$, w is smaller than v in lexicographic order.

Of course, such difficult open questions about transcendence are avatars of Grothendieck's period conjecture, see Section 13.2 in this book.

Some values of this sort, with computations mainly due to Zagier, are mentioned in Brown [Bro14, p. 16]:

$$\zeta(\underbrace{2, 2, \dots, 2}_n) = \frac{\pi^{2n}}{(2n+1)!},$$

and

$$\zeta(\underbrace{2, \dots, 2}_a, \underbrace{3, 2, \dots, 2}_b) = 2 \sum_{r=1}^{a+b+1} (-1)^r c_{a,b,r} \zeta(2r+1) \zeta(\underbrace{2, 2, \dots, 2}_{a+b+1-r}),$$

for $a, b \in \mathbb{N}_{>0}$, where

$$c_{a,b,r} := \left(\binom{2r}{2a+2} - (1-2^{-2r}) \binom{2r}{2b+1} \right).$$

We refer to the work of Brown [Bro12, Bro14] for the relation between the algebraic structures related to multiple zeta values and the Hopf algebra associated to the motivic Galois group of the Tannakian category of (unramified) mixed Tate motives over \mathbb{Z} (see Section 6.4). Then, one has:

Theorem 15.4.10 (Brown). *The periods of mixed Tate motives unramified over \mathbb{Z} are $\mathbb{Q}[\frac{1}{2\pi i}]$ -linear combinations of multiple zeta values.*

Proof. This is a result of Brown, see [Bro12, Del13]. □

In the next section, we relate multiple zeta values to Nori motives and also to mixed Tate motives. This give a more conceptual description of such periods in the sense of Chapter 6, see in particular Section 11.5.

15.5 Multiple zeta values and moduli space of marked curves

In this short section, we indicate how one can relate multiple zeta values to Nori motives in some other and surprising ways.

Multiple zeta values can also be regarded as periods of certain cohomology groups of moduli spaces. This viewpoint is discussed in Brown's thesis [Bro09]. In this way, they appear naturally as Nori motives. Recall that the moduli space $M_{0,n}$ of smooth rational curves with n marked points can be compactified to the space $\overline{M}_{0,n}$ of stable curves with n markings. Goncharov and Manin in [GM04] observed the following.

Theorem 15.5.1. *For each convergent multiple zeta value $p = \zeta(s_1, \dots, s_r)$ of weight $n = s_1 + \dots + s_r$, there are divisors A, B in $\overline{M}_{0,n+3}$ such that p is a period of the cohomology group $H^n(\overline{M}_{0,n+3} \setminus A, B \setminus (A \cap B))$.*

Thus, the group $H^n(\overline{M}_{0,n+3} \setminus A, B \setminus (A \cap B))$ immediately defines, of course, a motive in Nori's sense.

Example 15.5.2. The fundamental example is $\zeta(2)$, which we already described in Section 15.1. Here $\overline{M}_{0,5}$ is a compactification of

$$M_{0,5} = (\mathbb{P} \setminus \{0, 1, \infty\})^2 \setminus \text{diagonal},$$

and $\overline{M}_{0,5}$ is isomorphic to the blow up of $(0, 0)$, $(1, 1)$ and (∞, ∞) in $\mathbb{P}^1 \times \mathbb{P}^1$. This realises $\zeta(2)$ as the integral

$$\zeta(2) = \int_{0 \leq t_1 \leq t_2 \leq 1} \frac{dt_1}{1-t_2} \frac{dt_2}{t_2}.$$

We leave it to the reader to make the divisors A and B explicit.

Recent related research on higher polylogarithms and elliptic polylogarithms can be found in [BL11]. We do not want to explain this in full generality, but see the next section for an example.

15.6 Multiple Polylogarithms

In this section, we study a variation of cohomology groups in a 2-parameter family of varieties over \mathbb{Q} , the so-called *double logarithm variation*, for which multiple polylogarithms appear as coefficients. This viewpoint gives more examples of Kontsevich–Zagier periods occurring as cohomological periods of canonical cohomology groups at particular values of the parameters. The degeneration of the parameters specialises such periods to simpler ones.

First, define the *hyperlogarithm* as the iterated integral

$$I_n(a_1, \dots, a_n) := \int_{0 \leq t_1 \leq \dots \leq t_n \leq 1} \frac{dt_1}{t_1 - a_1} \wedge \dots \wedge \frac{dt_n}{t_n - a_n}$$

with $a_1, \dots, a_n \in \mathbb{C}$ (cf. [Zha02, p. 168]). Note that the order of terms here is different from the previous order, also in the infinite sum below.

These integrals specialise to the *multiple polylogarithm* (cf. [loc. cit.])

$$\text{Li}_{m_1, \dots, m_n} \left(\frac{a_2}{a_1}, \dots, \frac{a_n}{a_{n-1}}, \frac{1}{a_n} \right) := (-1)^n I_{\sum m_n} (a_1, \underbrace{0, \dots, 0}_{m_1-1}, \dots, a_n, \underbrace{0, \dots, 0}_{m_n-1}),$$

which is convergent if $1 < |a_1| < \dots < |a_n|$ (cf. [Gon01, 2.3, p. 9]). Alternatively, we can describe the multiple polylogarithm as a power series (cf. [Gon01, Theorem 2.2, p. 9])

$$\text{Li}_{m_1, \dots, m_n}(x_1, \dots, x_n) = \sum_{0 < k_1 < \dots < k_n} \frac{x_1^{k_1} \dots x_n^{k_n}}{k_1^{m_1} \dots k_n^{m_n}} \quad \text{for } |x_i| < 1. \quad (15.1)$$

Of special interest to us will be the *dilogarithm*

$$\text{Li}_2(x) = \sum_{k > 0} \frac{x^k}{k^2},$$

and the *double logarithm*

$$\text{Li}_{1,1}(x, y) = \sum_{0 < k < l} \frac{x^k y^l}{kl}.$$

Remark 15.6.1. At first, the functions $\text{Li}_{m_1, \dots, m_n}(x_1, \dots, x_n)$ only make sense for $|x_i| < 1$, but they can be analytically continued to multivalued meromorphic functions on \mathbb{C}^n (see [Zha02, p. 2]), for example $\text{Li}_1(x) = -\log(1-x)$. One has $\text{Li}_2(1) = \frac{\pi^2}{6}$ by Corollary 15.2.4.

15.6.1 The configuration

Let us consider the configuration

$$\begin{aligned} Y &:= \mathbb{A}^2 \quad \text{with coordinates } x \text{ and } y, \\ Z &:= \{x = a\} \cup \{y = b\} \quad \text{with } a \neq 0, 1 \quad \text{and } b \neq 0, 1 \\ X &:= Y \setminus Z \\ D &:= (\{x = 0\} \cup \{y = 1\} \cup \{x = y\}) \setminus Z, \end{aligned}$$

see Figure 15.3. We will also assume the condition $a \neq b$, although this is not needed in the beginning.

We denote the irreducible components of the divisor D as follows:

$$\begin{aligned} D_1 &:= \{x = 0\} \setminus \{(0, b)\}, \\ D_2 &:= \{y = 1\} \setminus \{(a, 1)\}, \quad \text{and} \\ D_3 &:= \{x = y\} \setminus \{(a, a), (b, b)\}. \end{aligned}$$

By projecting from Y onto the y - or x -axis, we get isomorphisms for the associated complex analytic spaces

$$D_1^{\text{an}} \cong \mathbb{C} \setminus \{b\}, \quad D_2^{\text{an}} \cong \mathbb{C} \setminus \{a\}, \quad \text{and} \quad D_3^{\text{an}} \cong \mathbb{C} \setminus \{a, b\}.$$

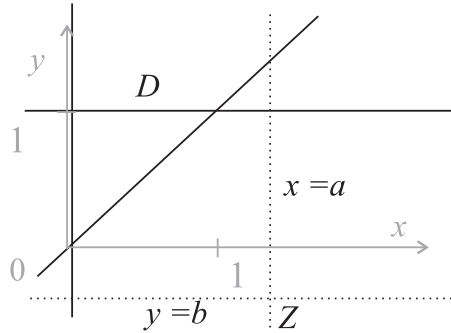

Fig. 15.3 The algebraic pair (X, D)

15.6.2 Singular homology

We can easily give generators for the second singular homology of the pair (X, D) , see Figure 15.4.

- Let $\alpha : [0, 1] \rightarrow \mathbb{C}$ be a smooth path, which does not meet a or b . We define a “triangle”

$$\Delta := \{(\alpha(s), \alpha(t)) \mid 0 \leq s \leq t \leq 1\} \subset \mathbb{C}^2.$$

- Consider the closed curve in \mathbb{C}

$$C_b := \left\{ \frac{a}{b + \epsilon e^{2\pi i s}} \mid s \in [0, 1] \right\},$$

which divides \mathbb{C} into two regions: an inner one containing $\frac{a}{b}$ and an outer one. We can choose $\epsilon > 0$ small enough such that C_b separates $\frac{a}{b}$ from 0 and 1, i.e., such that 0 and 1 are contained in the outer region. This allows us to find a smooth path $\beta : [0, 1] \rightarrow \mathbb{C}$ from 0 to 1 not meeting C_b . We define a “slanted tube”

$$S_b := \{(\beta(t) \cdot (b + \epsilon e^{2\pi i s}), b + \epsilon e^{2\pi i s}) \mid s, t \in [0, 1]\} \subset \mathbb{C}^2$$

which winds around $\{y = b\}$ and whose boundary components are supported on D_1 (corresponding to $t = 0$) and D_3 (corresponding to $t = 1$). The special choice of β guarantees $S_b \cap Z(\mathbb{C}) = \emptyset$.

- Similarly, we choose $\epsilon > 0$ such that the closed curve

$$C_a := \left\{ \frac{b-1}{a-1-\epsilon e^{2\pi i s}} \mid s \in [0, 1] \right\}$$

separates $\frac{b-1}{a-1}$ from 0 and 1. Let $\gamma : [0, 1] \rightarrow \mathbb{C}$ be a smooth path from 0 to 1 which does not meet C_a . We have a “slanted tube”

$$S_a := \{(a + \epsilon e^{2\pi i s}, 1 + \gamma(t) \cdot (a + \epsilon e^{2\pi i s} - 1)) \mid s, t \in [0, 1]\} \subset \mathbb{C}^2$$

winding around $\{x = a\}$ with boundary supported on D_2 and D_3 .

- Finally, we have a torus

$$T := \{(a + \epsilon e^{2\pi i s}, b + \epsilon e^{2\pi i t}) \mid s, t \in [0, 1]\}.$$

The 2-form $ds \wedge dt$ defines an orientation on the unit square $[0, 1]^2 = \{(s, t) \mid s, t \in [0, 1]\}$. Hence the manifolds with boundary Δ, S_b, S_a, T inherit an orientation, and since they can be triangulated, they give rise to smooth singular chains. By abuse of notation we will also write Δ, S_b, S_a, T

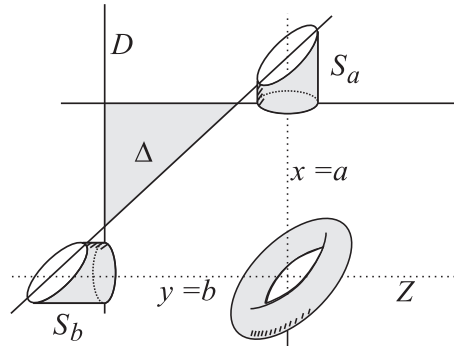

Fig. 15.4 Generators of $H_2^{\text{sing}}(X, D; \mathbb{Q})$

for these smooth singular chains. The homology classes of Δ , S_b , S_a and T will be denoted by γ_0 , γ_1 , γ_2 and γ_3 , respectively.

An inspection of the long exact sequence in singular homology will reveal that $\gamma_0, \dots, \gamma_3$ form a system of generators (see the following proof)

$$\begin{array}{ccccccc} H_2^{\text{sing}}(D, \mathbb{Q}) & \longrightarrow & H_2^{\text{sing}}(X, \mathbb{Q}) & \longrightarrow & H_2^{\text{sing}}(X, D, \mathbb{Q}) & \longrightarrow & \\ H_1^{\text{sing}}(D, \mathbb{Q}) & \xrightarrow{i_1} & H_1^{\text{sing}}(X, \mathbb{Q}) & & & & \end{array}$$

Proposition 15.6.2. *With notation as above, we have for the second singular homology of the pair (X, D)*

$$H_2^{\text{sing}}(X, D; \mathbb{Q}) = \mathbb{Q} \gamma_0 \oplus \mathbb{Q} \gamma_1 \oplus \mathbb{Q} \gamma_2 \oplus \mathbb{Q} \gamma_3.$$

Proof. For $c := a$ and $c := b$, the inclusion of the circle $\{c + \epsilon e^{2\pi i s} \mid s \in [0, 1]\}$ into $\mathbb{C} \setminus \{c\}$ is a homotopy equivalence, hence the product map $T \hookrightarrow X(\mathbb{C})$ is also a homotopy equivalence. This proves that

$$H_2^{\text{sing}}(X, \mathbb{Q}) = \mathbb{Q} \cdot [T],$$

while $H_1^{\text{sing}}(X, \mathbb{Q})$ has rank two with generators:

- one loop winding counterclockwise around $\{x = a\}$ once, but not around $\{y = b\}$, thus being homologous to both $\partial S_a \cap D_2(\mathbb{C})$ and $-\partial S_a \cap D_3(\mathbb{C})$, and
- another loop winding counterclockwise around $\{y = b\}$ once, but not around $\{x = a\}$, thus being homologous to $\partial S_b \cap D_1(\mathbb{C})$ and $-\partial S_b \cap D_3(\mathbb{C})$.

In order to compute the Betti numbers b_i of D , we use the spectral sequence for the closed covering $\{D_i\}$

$$E_1^{p,q} = \bigoplus_{|I|=p+1} H_{\text{dR}}^q(D_I, \mathbb{C}) \Rightarrow E_\infty^{p+q} = H_{\text{dR}}^{p+q}(D, \mathbb{C}),$$

with I a strictly ordered tuple of elements of $\{1, 2, 3\}$, and $D_I = \bigcap_{i \in I} D_i$. As the D_i are affine of dimension 1, cohomology is concentrated in degrees $q = 0, 1$. Moreover, $D_1 \cap D_2 \cap D_3 = \emptyset$, hence the spectral sequence is concentrated in $p = 0, 1$. We have

$$E_2^{p,q} : \begin{array}{cccc} \dots & 0 & 0 & 0 & 0 \dots \\ \dots & 0 & \bigoplus_{i=1}^3 H_{\text{dR}}^1(D_i, \mathbb{C}) & 0 & 0 \dots \\ \dots & 0 & \text{Ker } \delta & \text{Coker } \delta & 0 \dots \\ \dots & 0 & 0 & 0 & 0 \dots \end{array}$$

where

$$\delta : \bigoplus_{i=1}^3 H_{\text{dR}}^0(D_i, \mathbb{C}) \longrightarrow \bigoplus_{i < j} H_{\text{dR}}^0(D_{ij}, \mathbb{C}).$$

Note that this spectral sequence degenerates at E_2 . Since D is connected, we have $b_0 = 1$, i.e.,

$$1 = b_0 = \dim_{\mathbb{C}} E_{\infty}^0 = \dim_{\mathbb{C}} E_2^{0,0} = \dim_{\mathbb{C}} \text{Ker} \delta.$$

Hence

$$\begin{aligned} \dim_{\mathbb{C}} \text{Coker} \delta &= \dim_{\mathbb{C}} \text{codomain } \delta - \dim_{\mathbb{C}} \text{domain } \delta + \dim_{\mathbb{C}} \text{Ker} \delta \\ &= (1 + 1 + 1) - (1 + 1 + 1) + 1 = 1, \end{aligned}$$

and so

$$\begin{aligned} b_1 &= \dim_{\mathbb{C}} E_{\infty}^1 = \dim_{\mathbb{C}} E_2^{1,0} + \dim_{\mathbb{C}} E_2^{0,1} \\ &= \sum_{i=1}^3 \dim_{\mathbb{C}} H_{\text{dR}}^1(D_i, \mathbb{C}) + \dim_{\mathbb{C}} \text{Coker} \delta \\ &= \dim_{\mathbb{C}} H^1(\mathbb{C} \setminus \{b\}, \mathbb{C}) + \dim_{\mathbb{C}} H^1(\mathbb{C} \setminus \{a\}, \mathbb{C}) + \dim_{\mathbb{C}} H^1(\mathbb{C} \setminus \{a, b\}, \mathbb{C}) + 1 \\ &= (1 + 1 + 2) + 1 = 5. \end{aligned}$$

We can easily specify generators of $H_1^{\text{sing}}(D, \mathbb{Q})$ as follows

$$\mathbb{Q} \cdot (\partial S_b \cap D_1) \oplus \mathbb{Q} \cdot (\partial S_a \cap D_2) \oplus \mathbb{Q} \cdot (\partial S_b \cap D_3) \oplus \mathbb{Q} \cdot (\partial S_a \cap D_3) \oplus \mathbb{Q} \cdot \partial \Delta.$$

As D is affine of dimension 1, we have $b_2 = \dim_{\mathbb{C}} H_2^{\text{sing}}(D, \mathbb{Q}) = 0$. Now we can compute $\text{Ker}(i_1)$ and obtain

$$\mathbb{Q} \cdot \partial \Delta \oplus \mathbb{Q} \cdot (\partial S_b \cap D_1(\mathbb{C}) + \partial S_b \cap D_3(\mathbb{C})) \oplus \mathbb{Q} \cdot (\partial S_a \cap D_2(\mathbb{C}) + \partial S_a \cap D_3(\mathbb{C})).$$

This shows finally that

$$\dim_{\mathbb{Q}} H_2^{\text{sing}}(X, D; \mathbb{Q}) = \dim_{\mathbb{Q}} H_2^{\text{sing}}(X, \mathbb{Q}) + \dim_{\mathbb{Q}} \text{Ker}(i_1) = 1 + 3 = 4.$$

From these explicit calculations we also derive the linear independence of $\gamma_0 = [\Delta]$, $\gamma_1 = [S_b]$, $\gamma_2 = [S_a]$, $\gamma_3 = [T]$ and Proposition 15.6.2 is proved. \square

15.6.3 Smooth singular homology

Recall the definition of smooth singular cohomology from Definition 13.2.4. It computes singular cohomology by Theorem 2.2.5. With the various sign conventions made so far, the boundary map $\delta : S_2^{\infty}(X, D; \mathbb{Q}) \rightarrow S_1^{\infty}(X, D; \mathbb{Q})$ is given by

$$\delta : S_2^{\infty}(X, \mathbb{Q}) \oplus \bigoplus_{i=1}^3 S_1^{\infty}(D_i, \mathbb{Q}) \oplus \bigoplus_{i < j} S_0^{\infty}(D_{ij}, \mathbb{Q}) \rightarrow S_1^{\infty}(X, \mathbb{Q}) \oplus \bigoplus_{i=1}^3 S_0^{\infty}(D_i, \mathbb{Q})$$

$$\begin{aligned} & (\sigma, \sigma_1, \sigma_2, \sigma_3, \sigma_{12}, \sigma_{13}, \sigma_{23}) \mapsto \\ & (\partial\sigma + \sigma_1 + \sigma_2 + \sigma_3, -\partial\sigma_1 + \sigma_{12} + \sigma_{13}, -\partial\sigma_2 - \sigma_{12} + \sigma_{23}, -\partial\sigma_3 - \sigma_{13} - \sigma_{23}), \end{aligned}$$

where the little subscripts characterise the summand in which the element above lives. Thus the following elements of $C_2^\infty(X, D; \mathbb{Q})$ are cycles

$$\begin{aligned} \Gamma_0 & := (\Delta, -\partial\Delta \cap_1 D_1(\mathbb{C}), -\partial\Delta \cap_2 D_2(\mathbb{C}), -\partial\Delta \cap_3 D_3(\mathbb{C}), D_{12}(\mathbb{C}), -D_{13}(\mathbb{C}), D_{23}(\mathbb{C})), \\ \Gamma_1 & := (S_b, -\partial S_b \cap_1 D_1(\mathbb{C}), 0, -\partial S_b \cap_3 D_3(\mathbb{C}), 0, 0, 0), \\ \Gamma_2 & := (S_a, 0, -\partial S_a \cap_2 D_2(\mathbb{C}), -\partial S_a \cap_3 D_3(\mathbb{C}), 0, 0, 0), \\ \Gamma_3 & := (T, 0, 0, 0, 0, 0, 0). \end{aligned}$$

Under the isomorphism $H_2^\infty(X, D; \mathbb{Q}) \xrightarrow{\sim} H_2^{\text{sing}}(X, D; \mathbb{Q})$ the classes of these cycles $[\Gamma_0]$, $[\Gamma_1]$, $[\Gamma_2]$, $[\Gamma_3]$ are mapped to γ_0 , γ_1 , γ_2 , γ_3 , respectively.

15.6.4 Algebraic de Rham cohomology and the period matrix of (X, D)

Recall the definition of the complex $\tilde{\Omega}_{X,D}^\bullet$. We consider

$$\Gamma(X, \tilde{\Omega}_{X,D}^2) = \Gamma(X, \Omega_X^2) \oplus \bigoplus_{i=1}^3 \Gamma(D_i, \Omega_{D_i}^1) \oplus \bigoplus_{i < j} \Gamma(D_{ij}, \mathcal{O}_{D_{ij}})$$

together with the following cycles of $\Gamma(X, \tilde{\Omega}_{X,D}^2)$

- $\omega_0 := (0, 0, 0, 0, 0, 0, 1)$,
- $\omega_1 := (0, \frac{-dy}{y-b}, 0, 0, 0, 0, 0)$,
- $\omega_2 := (0, 0, \frac{-dx}{x-a}, 0, 0, 0, 0)$, and
- $\omega_3 := (\frac{dx \wedge dy}{(x-a)(y-b)}, 0, 0, 0, 0, 0, 0)$.

By computing the (transposed) period matrix $P_{ij} := \langle \Gamma_j, \omega_i \rangle$ and checking its non-degeneracy, we will show that $\omega_0, \dots, \omega_3$ span $H_{\text{dR}}^2(X, D)$.

Proposition 15.6.3. *Let X and D be as above. Then the second algebraic de Rham cohomology group $H_{\text{dR}}^2(X, D)$ of the pair (X, D) is generated by the cycles $\omega_0, \dots, \omega_3$ considered above.*

Proof. Easy calculations give us the (transposed) period matrix P :

$$\begin{array}{c|cccc}
 & \Gamma_0 & \Gamma_1 & \Gamma_2 & \Gamma_3 \\
 \hline
 \omega_0 & 1 & 0 & 0 & 0 \\
 \omega_1 & \text{Li}_1\left(\frac{1}{b}\right) & 2\pi i & 0 & 0 \\
 \omega_2 & \text{Li}_1\left(\frac{1}{a}\right) & 0 & 2\pi i & 0 \\
 \omega_3 & ? & 2\pi i \text{Li}_1\left(\frac{b}{a}\right) & 2\pi i \log\left(\frac{a-b}{1-b}\right) & (2\pi i)^2.
 \end{array}$$

For example,

- $P_{1,1} = \langle \Gamma_1, \omega_1 \rangle = \int_{-\partial S_b \cap D_1(\mathbb{C})} \frac{-dy}{y-b}$
 $= \int_{|y-b|=\epsilon} \frac{dy}{y-b}$
 $= 2\pi i,$
- $P_{3,3} = \langle \Gamma_3, \omega_3 \rangle = \int_T \frac{dx}{x-a} \wedge \frac{dy}{y-b}$
 $= \left(\int_{|x-a|=\epsilon} \frac{dx}{x-a} \right) \cdot \left(\int_{|y-b|=\epsilon} \frac{dy}{y-b} \right)$ by Fubini
 $= (2\pi i)^2,$
- $P_{1,0} = \langle \Gamma_0, \omega_1 \rangle = \int_{-\partial \Delta \cap D_1(\mathbb{C})} \frac{-dy}{y-b}$
 $= \int_0^1 \frac{-\alpha(t)}{\alpha(t)-b}$
 $= -[\log(\alpha(t)-b)]_0^1$
 $= -\log\left(\frac{1-b}{-b}\right)$
 $= -\log\left(1 - \frac{1}{b}\right)$
 $= \text{Li}_1\left(\frac{1}{b}\right),$ and
- $P_{3,1} = \langle \Gamma_1, \omega_3 \rangle = \int_{S_b} \frac{dx}{x-a} \wedge \frac{dy}{y-b}$
 $= \int_{[0,1]^2} \frac{d(\beta(t) \cdot (b + \epsilon e^{2\pi i s}))}{\beta(t) \cdot (b + \epsilon e^{2\pi i s}) - a} \wedge \frac{d(b + \epsilon e^{2\pi i s})}{\epsilon e^{2\pi i s}}$
 $= \int_{[0,1]^2} \frac{b + \epsilon e^{2\pi i s}}{\beta(t) \cdot (b + \epsilon e^{2\pi i s}) - a} d\beta(t) \wedge 2\pi i ds$
 $= - \int_0^1 \left[\frac{a \log(\beta(t) \cdot (b + \epsilon e^{2\pi i s}) - a) - 2\pi i \beta(t) b s}{\beta(t) \cdot (-\beta(t) b + a)} \right]_0^1 d\beta(t)$
 $= -2\pi i \int_0^1 \frac{d\beta(t)}{\beta(t) - \frac{a}{b}}$
 $= -2\pi i [\log(\beta(t) - \frac{a}{b})]_0^1$
 $= -2\pi i \log\left(\frac{1 - \frac{a}{b}}{-\frac{a}{b}}\right)$
 $= -2\pi i \log\left(1 - \frac{a}{b}\right)$
 $= 2\pi i \text{Li}_1\left(\frac{b}{a}\right).$

Obviously, the period matrix P is non-degenerate and so Proposition 15.6.3 is proved. \square

What about the entry $P_{3,0}$?

Proposition 15.6.4. $P_{3,0} = \text{Li}_{1,1}\left(\frac{b}{a}, \frac{1}{b}\right)$.

Proof. For the proof we need to show that $\langle T_0, \omega_3 \rangle = \text{Li}_{1,1}\left(\frac{b}{a}, \frac{1}{b}\right)$, where $\text{Li}_{1,1}(x, y)$ is an analytic continuation of the double logarithm defined for $|x|, |y| < 1$ at the beginning of Section 15.6. The following Lemma 15.6.5 describes this analytic continuation in detail, and therefore completes the proof. Our approach is similar to the one taken in [Gon01, 2.3, p. 9], but differs from that in [Zha07, p. 7]. \square

Before stating Lemma 15.6.5, we need to explain some more notation. Let $B^{\text{an}} := (\mathbb{C} \setminus \{0, 1\})^2$ be the parameter space and choose a point $(a, b) \in B^{\text{an}}$. For $\epsilon > 0$ we denote by $D_\epsilon(a, b)$ the polycylinder

$$D_\epsilon(a, b) := \{(a', b') \in B^{\text{an}} \mid |a' - a| < \epsilon, |b' - b| < \epsilon\}.$$

If $\alpha : [0, 1] \rightarrow \mathbb{C}$ is a smooth path from 0 to 1 passing through neither a nor b , then there exists an $\epsilon > 0$ such that $\text{Im}(\alpha)$ does not meet any of the discs

$$\begin{aligned} D_{2\epsilon}(a) &:= \{a' \in \mathbb{C} \mid |a' - a| < 2\epsilon\}, \quad \text{and} \\ D_{2\epsilon}(b) &:= \{b' \in \mathbb{C} \mid |b' - b| < 2\epsilon\}. \end{aligned}$$

Hence the power series (15.2) below

$$\begin{aligned} &\left(\frac{1}{\alpha(s) - a'}\right) \left(\frac{1}{\alpha(t) - b'}\right) \\ &= \left(\frac{1}{\alpha(s) - a}\right) \left(\frac{1}{1 - \frac{a' - a}{\alpha(s) - a}}\right) \left(\frac{1}{\alpha(t) - b}\right) \left(\frac{1}{1 - \frac{b' - b}{\alpha(t) - b}}\right) \\ &= \sum_{k,l=0}^{\infty} \underbrace{\frac{1}{(\alpha(s) - a)^{k+1} (\alpha(t) - b)^{l+1}}}_{c_{k,l}} (a' - a)^k (b' - b)^l \quad (15.2) \end{aligned}$$

has coefficients $c_{k,l}$ satisfying

$$|c_{k,l}| < \left(\frac{1}{2\epsilon}\right)^{k+l+2}.$$

In particular, (15.2) converges uniformly for $(a', b') \in D_\epsilon(a, b)$ and we see that the integral

$$\begin{aligned} I_2^\alpha(a', b') &:= \int_{0 \leq s \leq t \leq 1} \frac{d\alpha(s)}{\alpha(s) - a'} \wedge \frac{d\alpha(t)}{\alpha(t) - b'} \\ &= \sum_{k,l=0}^{\infty} \left(\int_{0 \leq s \leq t \leq 1} \frac{d\alpha(s)}{(\alpha(s) - a)^{k+1}} \wedge \frac{d\alpha(t)}{(\alpha(t) - b)^{l+1}} \right) (a' - a)^k (b' - b)^l \end{aligned}$$

defines an analytic function on $D_\epsilon(a, b)$. In fact, by the same argument we get an analytic function I_2^α on all of $(\mathbb{C} \setminus \text{Im}\alpha)^2$.

Now let $\alpha_r : [0, 1] \rightarrow \mathbb{C} \setminus (D_{2\epsilon}(a) \cup D_{2\epsilon}(b))$ with $r \in [0, 1]$ be a smooth homotopy of paths from 0 to 1, i.e. $\alpha_r(0) = 0$ and $\alpha_r(1) = 1$ for all $r \in [0, 1]$. We will prove that

$$I_2^{\alpha_0}(a', b') = I_2^{\alpha_1}(a', b') \quad \text{for all } (a', b') \in D_\epsilon(a, b).$$

Define a subset $\Gamma \subset \mathbb{C}^2$

$$\Gamma := \{(\alpha_r(s), \alpha_r(t)) \mid 0 \leq s \leq t \leq 1, r \in [0, 1]\}.$$

The boundary of Γ is built out of five components (each being a manifold with boundary)

- $\Gamma_{s=0} := \{(0, \alpha_r(t)) \mid r, t \in [0, 1]\}$,
- $\Gamma_{s=t} := \{(\alpha_r(s), \alpha_r(s)) \mid r, s \in [0, 1]\}$,
- $\Gamma_{t=1} := \{(\alpha_r(s), 1) \mid r, s \in [0, 1]\}$,
- $\Gamma_{r=0} := \{(\alpha_0(s), \alpha_0(t)) \mid 0 \leq s \leq t \leq 1\}$,
- $\Gamma_{r=1} := \{(\alpha_1(s), \alpha_1(t)) \mid 0 \leq s \leq t \leq 1\}$.

Let $(a', b') \in D_\epsilon(a, b)$. Since the restriction of $\frac{dx}{x-a'} \wedge \frac{dy}{y-b'}$ to $\Gamma_{s=0}$, $\Gamma_{s=t}$ and $\Gamma_{t=1}$ is zero, we get by Stokes' theorem

$$\begin{aligned} 0 &= \int_\Gamma 0 = \int_\Gamma d \frac{dx}{x-a'} \wedge \frac{dy}{y-b'} \\ &= \int_{\partial\Gamma} \frac{dx}{x-a'} \wedge \frac{dy}{y-b'} \\ &= \int_{\Gamma_{r=1} - \Gamma_{r=0}} \frac{dx}{x-a'} \wedge \frac{dy}{y-b'} \\ &= I_2^{\alpha_1}(a', b') - I_2^{\alpha_0}(a', b'). \end{aligned}$$

For each pair of smooth paths $\alpha_0, \alpha_1 : [0, 1] \rightarrow \mathbb{C}$ from 0 to 1, we can find a homotopy α_r relative to $\{0, 1\}$ between both paths. Since $\text{Im}(\alpha_r)$ is compact, we also find a point $(a, b) \in B^{\text{an}} = (\mathbb{C} \setminus \{0, 1\})^2$ and an $\epsilon > 0$ such that $\text{Im}(\alpha_r)$ does not meet $D_{2\epsilon}(a, b)$ or $D_{2\epsilon}(a, b)$. Then $I_2^{\alpha_0}$ and $I_2^{\alpha_1}$ must agree on $D_\epsilon(a, b)$. By the identity principle for analytic functions of several complex variables [Gun90], the functions $I_2^\alpha(a', b')$, each defined on $(\mathbb{C} \setminus \text{Im}(\alpha))^2$, patch together to give a multivalued analytic function on $B^{\text{an}} = (\mathbb{C} \setminus \{0, 1\})^2$.

Lemma 15.6.5. *The integrals*

$$I_2^\alpha\left(\frac{1}{xy}, \frac{1}{y}\right) = \int_{0 \leq s \leq t \leq 1} \frac{d\alpha(s)}{\alpha(s) - \frac{1}{xy}} \wedge \frac{d\alpha(t)}{\alpha(t) - \frac{1}{y}}$$

provide a genuine analytic continuation of $\text{Li}_{1,1}(x, y)$ to a multivalued function which is defined on $\{(x, y) \in \mathbb{C}^2 \mid x, y \neq 0, xy \neq 1, y \neq 1\}$.

Proof. Assume $1 < |b| < |a|$ without loss of generality. Then we can take $\alpha = \text{id} : [0, 1] \rightarrow \mathbb{C}, s \mapsto s$, and obtain

$$I_2^{\text{id}}(a, b) = I_2(a, b) = \text{Li}_{1,1}\left(\frac{b}{a}, \frac{1}{y}\right),$$

where $\text{Li}_{1,1}(x, y)$ is the double logarithm defined for $|x|, |y| < 1$ in Subsection 15.6. Thus we have proved the lemma. \square

Definition 15.6.6 (Double logarithm). We call the analytic continuation from Lemma 15.6.5 the *double logarithm* as well and continue to use the notation $\text{Li}_{1,1}(x, y)$.

The period matrix P is thus given by:

	Γ_0	Γ_1	Γ_2	Γ_3
ω_0	1	0	0	0
ω_1	$\text{Li}_1(\frac{1}{b})$	$2\pi i$	0	0
ω_2	$\text{Li}_1(\frac{1}{a})$	0	$2\pi i$	0
ω_3	$\text{Li}_{1,1}(\frac{b}{a}, \frac{1}{b})$	$2\pi i \text{Li}_1(\frac{b}{a})$	$2\pi i \log(\frac{a-b}{1-b})$	$(2\pi i)^2$.

15.6.5 Varying the parameters a and b

The homology group $H_2^{\text{sing}}(X, D; \mathbb{Q})$ of the pair (X, D) carries a \mathbb{Q} -MHS (W_\bullet, F^\bullet) . The weight filtration is given in terms of the $\{\gamma_j\}$:

$$W_p H_2^{\text{sing}}(X, D; \mathbb{Q}) = \begin{cases} 0 & \text{for } p \leq -5 \\ \mathbb{Q}\gamma_3 & \text{for } p = -4, -3 \\ \mathbb{Q}\gamma_1 \oplus \mathbb{Q}\gamma_2 \oplus \mathbb{Q}\gamma_3 & \text{for } p = -2, -1 \\ \mathbb{Q}\gamma_0 \oplus \mathbb{Q}\gamma_1 \oplus \mathbb{Q}\gamma_2 \oplus \mathbb{Q}\gamma_3 & \text{for } p \geq 0. \end{cases}$$

The Hodge filtration is given in terms of the $\{\omega_i^*\}$:

$$F^p H_2^{\text{sing}}(X, D; \mathbb{C}) = \begin{cases} \mathbb{C}\omega_0^* \oplus \mathbb{C}\omega_1^* \oplus \mathbb{C}\omega_2^* \oplus \mathbb{C}\omega_3^* & \text{for } p \leq -2 \\ \mathbb{C}\omega_0^* \oplus \mathbb{C}\omega_1^* \oplus \mathbb{C}\omega_2^* & \text{for } p = -1 \\ \mathbb{C}\omega_0^* & \text{for } p = 0 \\ 0 & \text{for } p \geq 1. \end{cases}$$

This \mathbb{Q} -MHS very closely resembles the \mathbb{Q} -MHS considered in [Gon97, 2.2, p. 620] and [Zha07, 3.2, p. 6]. Nevertheless, a few differences are worth mentioning:

- Goncharov defines the weight filtration slightly differently, for example his lowest weight is -6 .

- The entry $P_{3,2} = 2\pi i \log\left(\frac{a-b}{1-b}\right)$ of the period matrix P differs by $(2\pi i)^2$, or put differently, the basis $\{\gamma_0, \gamma_1, \gamma_2 - \gamma_3, \gamma_3\}$ is used.

Up to now, the parameters a and b of the configuration (X, D) have been fixed. By varying a and b , we obtain a family of configurations. Equip $\mathbb{A}_{\mathbb{C}}^2$ with coordinates a and b and let

$$B := \mathbb{A}_{\mathbb{C}}^2 \setminus (\{a = 0\} \cup \{a = 1\} \cup \{b = 0\} \cup \{b = 1\})$$

be the parameter space. Take another copy of $\mathbb{A}_{\mathbb{C}}^2$ with coordinates x and y and define total spaces

$$\begin{aligned} \underline{X} &:= (B \times \mathbb{A}_{\mathbb{C}}^2) \setminus (\{x = a\} \cup \{y = b\}), \quad \text{and} \\ \underline{D} &:= "B \times D" = \underline{X} \cap (\{x = 0\} \cup \{y = 1\} \cup \{x = y\}). \end{aligned}$$

We now have a projection

$$\begin{array}{ccc} \underline{D} \hookrightarrow \underline{X} & (a, b, x, y) & \\ \searrow \downarrow \pi & \downarrow & \\ & B & (a, b) \end{array},$$

whose fibre over a closed point $(a, b) \in B$ is precisely the configuration (X, D) for the parameter choice a, b . The morphism π is flat. The assignment

$$(a, b) \mapsto (V_{\mathbb{Q}}, W_{\bullet}, F^{\bullet}),$$

where

$$\begin{aligned} V_{\mathbb{Q}} &:= \text{span}_{\mathbb{Q}}\{s_0, \dots, s_3\}, \\ V_{\mathbb{C}} &:= \mathbb{C}^4 \quad \text{with standard basis } e_0, \dots, e_3, \end{aligned}$$

$$\begin{aligned} s_0 &:= \begin{pmatrix} 1 \\ \text{Li}\left(\frac{1}{b}\right) \\ \text{Li}_1\left(\frac{1}{a}\right) \\ \text{Li}_{1,1}\left(\frac{b}{a}, \frac{1}{b}\right) \end{pmatrix}, \quad s_1 := \begin{pmatrix} 0 \\ 2\pi i \\ 0 \\ 2\pi i \text{Li}_1\left(\frac{b}{a}\right) \end{pmatrix}, \\ s_2 &:= \begin{pmatrix} 0 \\ 0 \\ 2\pi i \\ 2\pi i \log\left(\frac{a-b}{1-b}\right) \end{pmatrix}, \quad s_3 := \begin{pmatrix} 0 \\ 0 \\ 0 \\ (2\pi i)^2 \end{pmatrix}, \end{aligned}$$

with filtrations

$$W_p V_{\mathbb{Q}} = \begin{cases} 0 & \text{for } p \leq -5 \\ \mathbb{Q}s_3 & \text{for } p = -4, -3 \\ \mathbb{Q}s_1 \oplus \mathbb{Q}s_2 \oplus \mathbb{Q}s_3 & \text{for } p = -2, -1 \\ V_{\mathbb{Q}} & \text{for } p \geq 0, \text{ and} \end{cases}$$

$$F^p V_{\mathbb{C}} = \begin{cases} V_{\mathbb{C}} & \text{for } p \leq -2 \\ \mathbb{C}e_0 \oplus \mathbb{C}e_1 \oplus \mathbb{C}e_2 & \text{for } p = -1 \\ \mathbb{C}e_0 & \text{for } p = 0 \\ 0 & \text{for } p \geq 1 \end{cases}$$

defines a good unipotent variation of \mathbb{Q} -MHS on B^{an} . We refer to the literature, e.g. [Hai94, HZ87, PS08], for more details on unipotent variations. Note that the Hodge filtration F^{\bullet} does not depend on $(a, b) \in B^{\text{an}}$.

One of the main characteristics of good unipotent variations of \mathbb{Q} -MHS is that they can be extended to a compactification of the base space (if the complement is a divisor with normal crossings).

The algorithm for computing these extensions, so-called *limiting mixed \mathbb{Q} -Hodge structures*, can be found in [Hai94, 7, p. 24f] and [Zha04, 4, p. 12].

In a first step, we extend the variation to the divisor $\{a = 1\}$ minus the point $(1, 0)$ and then in a second step we extend it to the point $(1, 0)$. In particular, we assume that a branch has been picked for each entry P_{ij} of P . We will follow [Zha04, 4.1, p. 14f] very closely.

First step: Let σ be the loop winding counterclockwise around $\{a = 1\}$ once, but not around $\{a = 0\}$, $\{b = 0\}$ or $\{b = 1\}$. If we analytically continue an entry P_{ij} of P along σ we possibly get a second branch of the same multivalued function. In fact, the matrix resulting from analytic continuation of every entry along σ will be of the form

$$P \cdot T_{\{a=1\}},$$

where

$$T_{\{a=1\}} = \begin{pmatrix} 1 & 0 & 0 & 0 \\ 0 & 1 & 0 & 0 \\ -1 & 0 & 1 & 0 \\ 0 & 0 & 0 & 1 \end{pmatrix}$$

is the *monodromy matrix* corresponding to σ . The *local monodromy logarithm* is defined as

$$N_{\{a=1\}} = \frac{\log T_{\{a=1\}}}{2\pi i} = \frac{1}{2\pi i} \sum_{n=1}^{\infty} \frac{-1}{n} \left(\begin{pmatrix} 1 & & & \\ & 1 & & \\ & & 1 & \\ & & & 1 \end{pmatrix} - T_{\{a=1\}} \right)^n$$

$$= \begin{pmatrix} 0 & 0 & 0 & 0 \\ 0 & 0 & 0 & 0 \\ \frac{-1}{2\pi i} & 0 & 0 & 0 \\ 0 & 0 & 0 & 0 \end{pmatrix}.$$

We want to extend our \mathbb{Q} -MHS along the tangent vector $\frac{\partial}{\partial a}$, i.e., we introduce a local coordinate $t := a - 1$ and compute the *limit period matrix*

$$\begin{aligned}
P_{\{a=1\}} &:= \lim_{t \rightarrow 0} P \cdot e^{-\log(t) \cdot N_{\{a=1\}}} \\
&= \lim_{t \rightarrow 0} \begin{pmatrix} 1 & 0 & 0 & 0 \\ \operatorname{Li}_1\left(\frac{1}{b}\right) & 2\pi i & 0 & 0 \\ \operatorname{Li}_1\left(\frac{1}{1+t}\right) & 0 & 2\pi i & 0 \\ \operatorname{Li}_{1,1}\left(\frac{b}{1+t}, \frac{1}{b}\right) & 2\pi i \operatorname{Li}_1\left(\frac{b}{1+t}\right) & 2\pi i \log\left(\frac{1-b+t}{1-b}\right) & (2\pi i)^2 \end{pmatrix} \cdot \begin{pmatrix} 1 & 0 & 0 \\ 0 & 1 & 0 \\ \frac{\log(t)}{2\pi i} & 0 & 1 \\ 0 & 0 & 1 \end{pmatrix} \\
&= \lim_{t \rightarrow 0} \begin{pmatrix} 1 & 0 & 0 & 0 \\ \operatorname{Li}_1\left(\frac{1}{b}\right) & 2\pi i & 0 & 0 \\ \operatorname{Li}_1\left(\frac{1}{1+t}\right) + \log(t) & 0 & 2\pi i & 0 \\ \operatorname{Li}_{1,1}\left(\frac{b}{1+t}, \frac{1}{b}\right) + \log\left(\frac{1-b+t}{1-b}\right) \cdot \log(t) & 2\pi i \operatorname{Li}_1\left(\frac{b}{1+t}\right) & 2\pi i \log\left(\frac{1-b+t}{1-b}\right) & (2\pi i)^2 \end{pmatrix} \\
&\stackrel{(*)}{=} \begin{pmatrix} 1 & 0 & 0 & 0 \\ \operatorname{Li}_1\left(\frac{1}{b}\right) & 2\pi i & 0 & 0 \\ 0 & 0 & 2\pi i & 0 \\ -\operatorname{Li}_2\left(\frac{1}{1-b}\right) & 2\pi i \operatorname{Li}_1(b) & 0 & (2\pi i)^2 \end{pmatrix}.
\end{aligned}$$

Here we used at (*)

- $P_{\{a=1\}2,0} = \lim_{t \rightarrow 0} \operatorname{Li}_1\left(\frac{1}{1+t}\right) + \log(t)$
 $= \lim_{t \rightarrow 0} -\log\left(1 - \frac{1}{1+t}\right) + \log(t)$
 $= \lim_{t \rightarrow 0} -\log(t) + \log(1+t) + \log(t)$
 $= 0, \quad \text{and}$
- $P_{\{a=1\}3,0} = \lim_{t \rightarrow 0} \operatorname{Li}_{1,1}\left(\frac{b}{1+t}, \frac{1}{b}\right) + \log\left(\frac{1-b+t}{1-b}\right) \cdot \log(t)$
 $= \operatorname{Li}_{1,1}\left(b, \frac{1}{b}\right) \quad \text{by L'Hospital}$
 $= -\operatorname{Li}_2\left(\frac{1}{1-b}\right).$

The vectors s_0, s_1, s_2, s_3 spanning the \mathbb{Q} -lattice of the limit \mathbb{Q} -MHS on $\{a=1\} \setminus \{(1,0)\}$ are now given by the columns of the limit period matrix

$$s_0 = \begin{pmatrix} 1 \\ \operatorname{Li}_1\left(\frac{1}{b}\right) \\ 0 \\ -\operatorname{Li}_2\left(\frac{1}{1-b}\right) \end{pmatrix}, \quad s_1 = \begin{pmatrix} 0 \\ 2\pi i \\ 0 \\ 2\pi i \operatorname{Li}_1(b) \end{pmatrix}, \quad s_2 = \begin{pmatrix} 0 \\ 0 \\ 2\pi i \\ 0 \end{pmatrix}, \quad s_3 = \begin{pmatrix} 0 \\ 0 \\ 0 \\ (2\pi i)^2 \end{pmatrix}.$$

The weight and Hodge filtration of the limit \mathbb{Q} -MHS can be expressed in terms of the s_j and the standard basis vectors e_i of \mathbb{C}^4 . This gives us a variation of \mathbb{Q} -MHS on the divisor $\{a=1\} \setminus \{(1,0)\}$. This variation is actually (up to signs) an extension of Deligne's famous *dilogarithm variation* considered,

for example, in [Kle01, 4.2, p. 38f]. In loc. cit. the geometric origin of this variation is explained in detail.

Second step: We now extend this variation along the tangent vector $\frac{\partial}{\partial b}$ to the point $(1, 0)$, i.e. we write $b = -t$ with a local coordinate t . Let σ be the loop in $\{a = 1\} \setminus \{(1, 0)\}$ winding counterclockwise around $(1, 0)$ once, but not around $(1, 1)$. Then the monodromy matrix corresponding to σ is given by

$$T_{(1,0)} = \begin{pmatrix} 1 & 0 & 0 & 0 \\ 1 & 1 & 0 & 0 \\ 0 & 0 & 1 & 0 \\ 0 & 0 & 0 & 1 \end{pmatrix},$$

hence the local monodromy logarithm is given by

$$N_{(1,0)} = \frac{\log T_{(1,0)}}{2\pi i} = \begin{pmatrix} 0 & 0 & 0 & 0 \\ \frac{1}{2\pi i} & 0 & 0 & 0 \\ 0 & 0 & 0 & 0 \\ 0 & 0 & 0 & 0 \end{pmatrix}.$$

Thus we get for the limit period matrix

$$\begin{aligned} P_{(1,0)} &:= \lim_{t \rightarrow 0} P_{\{a=1\}} \cdot e^{-\log(t) \cdot N_{(1,0)}} \\ &= \lim_{t \rightarrow 0} \begin{pmatrix} 1 & 0 & 0 & 0 \\ \operatorname{Li}_1\left(\frac{-1}{t}\right) & 2\pi i & 0 & 0 \\ 0 & 0 & 2\pi i & 0 \\ -\operatorname{Li}_2\left(\frac{1}{1+t}\right) & 2\pi i \operatorname{Li}_1(-t) & 0 & (2\pi i)^2 \end{pmatrix} \cdot \begin{pmatrix} 1 & 0 & 0 & 0 \\ \frac{-\log(t)}{2\pi i} & 1 & 0 & 0 \\ 0 & 0 & 1 & 0 \\ 0 & 0 & 0 & 1 \end{pmatrix} \\ &= \lim_{t \rightarrow 0} \begin{pmatrix} 1 & 0 & 0 & 0 \\ \operatorname{Li}_1\left(\frac{-1}{t}\right) - \log(t) & 2\pi i & 0 & 0 \\ 0 & 0 & 2\pi i & 0 \\ -\operatorname{Li}_2\left(\frac{1}{1+t}\right) - \operatorname{Li}_1(-t) \cdot \log(t) & 0 & 0 & (2\pi i)^2 \end{pmatrix} \\ &\stackrel{(*)}{=} \begin{pmatrix} 1 & 0 & 0 & 0 \\ 0 & 2\pi i & 0 & 0 \\ 0 & 0 & 2\pi i & 0 \\ -\zeta(2) & 0 & 0 & (2\pi i)^2 \end{pmatrix}. \end{aligned}$$

We remark that in the last matrix we see a decomposition into two (2×2) -blocks, one consisting of a pure Tate motive, the other involving $\zeta(2)$.

Here we used at $(*)$

- $P_{(1,0)_{1,0}} = \lim_{t \rightarrow 0} \operatorname{Li}_1\left(\frac{-1}{t}\right) - \log(t)$
 $= \lim_{t \rightarrow 0} -\log\left(1 + \frac{1}{t}\right) - \log(t)$
 $= \lim_{t \rightarrow 0} -\log(1+t) + \log(t) - \log(t)$
 $= 0, \quad \text{and}$
- $P_{(1,0)_{3,0}} = \lim_{t \rightarrow 0} -\operatorname{Li}_2\left(\frac{1}{1+t}\right) - \operatorname{Li}_1(-t) \cdot \log(t)$

$$\begin{aligned} &= \lim_{t \rightarrow 0} \operatorname{Li}_2\left(\frac{1}{1+t}\right) + \log(1+t) \cdot \log(t) \\ &= -\operatorname{Li}_2(1) \quad \text{by L'Hospital} \\ &= -\zeta(2). \end{aligned}$$

As in the previous step, the vectors s_0, s_1, s_2, s_3 spanning the \mathbb{Q} -lattice of the limit \mathbb{Q} -MHS are given by the columns of the limit period matrix $P_{(1,0)}$ and weight and Hodge filtrations by the formulae in Subsection 15.6.5.

So we obtained $-\zeta(2)$ as a “period” of a limiting \mathbb{Q} -MHS.

Chapter 16

Miscellaneous periods: an outlook

In this chapter, we collect several other important examples of periods in the literature for the convenience of the reader.

16.1 Special values of L -functions

The Beilinson conjectures give a formula for the values (more precisely, the leading coefficients) of L -functions of motives at certain integers. We sketch the formulation in order to explain why these numbers are expected to be periods.

In this section, fix the base field $k = \mathbb{Q}$. Let $G_{\mathbb{Q}} = \text{Gal}(\bar{\mathbb{Q}}/\mathbb{Q})$ be the absolute Galois group. For any prime p , let $I_p \subset G_{\mathbb{Q}}$ be the inertia group. Let $\text{Fr}_p \in G_{\mathbb{Q}}/I_p = \text{Gal}(\bar{\mathbb{F}}_p/\mathbb{F}_p)$ be the Frobenius $a \mapsto a^p$.

In order to be able to formulate the conjectures on special values of L -functions, we need the existence of a \mathbb{Q} -linear abelian category of mixed motives with all the expected properties. This can be made precise by asking the functor

$$DM_{\text{gm}, \mathbb{Q}} \rightarrow D^b(\mathcal{MM}_{\text{Nori}, \mathbb{Q}})$$

to be an equivalence of categories. Let M be a mixed motive over \mathbb{Q} with coefficients in \mathbb{Q} . For any prime l , it has an l -adic realisation M_l which is a finite-dimensional \mathbb{Q}_l -vector space with a continuous operation of the absolute Galois group $G_{\mathbb{Q}}$.

Definition 16.1.1. Let M be as above, p a prime and l a prime different from p . We define

$$P_p(M, t)_l := \det(1 - \text{Fr}_p t | M_l^{I_p}) \in \mathbb{Q}_l[t].$$

It is conjectured that $P_p(M, t)_l$ is in $\mathbb{Q}[t]$, and independent of l . We denote this polynomial by $P_p(M, t)$.

Example 16.1.2. Let $M = H^i(X)$ for a smooth projective variety X over \mathbb{Q} with good reduction at p . Then the conjecture holds by the Weil conjectures proved by Deligne. In the special case $X = \text{Spec}(\mathbb{Q})$, we get

$$P_p(H(\text{Spec}(\mathbb{Q})), t) = 1 - t.$$

In the special case $X = \mathbb{P}^1$, $i = 1$, we get

$$P_p(H^2(\mathbb{P}^1), t) = 1 - pt.$$

Definition 16.1.3. Let M be as above. We define

$$L(M, s) := \prod_{p \text{ prime}} \frac{1}{P_p(M, p^{-s})}$$

as a function of the variable $s \in \mathbb{C}$. For $n \in \mathbb{Z}$, let

$$L(M, n)^*$$

be the leading coefficient of the Laurent expansion of $L(M, s)$ around n .

It is conjectured that the infinite product converges for $\text{Re}(s)$ big enough and that the function has a meromorphic continuation to all of \mathbb{C} .

Example 16.1.4. Let $M = H^i(X)$ for X a smooth projective variety over \mathbb{Q} . We want to prove the convergence of $L(M, s)$. Note that X has good reduction at almost all p . It suffices to consider these. The zeros of $P_p(M, t)$ are known to have absolute value $p^{-\frac{i}{2}}$ by the Riemann hypothesis part of the Weil conjectures (a theorem of Deligne, see [Del74a]). This implies convergence by a simple analytic argument. Analytic continuation is a very deep conjecture. It holds for all 0-dimensional X . Indeed, for any number field K , we have

$$L(H^0(\text{Spec}(K)), s) = \zeta_K(s)$$

where $\zeta_K(s)$ is the Dedekind ζ -function. For $M = H^1(E)$ with E an elliptic curve over \mathbb{Q} , we have

$$L(H^1(E), s) = L(E, s)$$

where the right-hand side is the L -function of the elliptic curve, see e.g. [Sil86, §16]. Analytic continuation holds, because E is modular.

Example 16.1.5. Let M be as above, $\mathbb{Q}(-1) = H^2(\mathbb{P}^1)$ be the Lefschetz motive. We put $M(-1) = M \otimes \mathbb{Q}(-1)$. Then

$$L(M(-1), s) = L(M, s - 1)$$

by the formula for $P_p(\mathbb{Q}(-1), t)$ above.

Hence, the Beilinson conjecture on $L(M, s)$ at $s = n \in \mathbb{Z}$ can be reduced to the Beilinson conjecture on $L(M(n), s)$ at $s = 0$.

Conjecture 16.1.6 (Beilinson [Beĭ84], [Sch91]). *Let M be a motive over \mathbb{Q} . Then the vanishing order of $L(M, s)$ at $s = 0$ is given by*

$$\dim H_{\mathcal{M},f}^1(\mathrm{Spec}(\mathbb{Q}), M^*(1)) - \dim H_{\mathcal{M},f}^0(\mathrm{Spec}(\mathbb{Q}), M),$$

where $H_{\mathcal{M},f}$ is unramified motivic cohomology. In particular, unramified motivic cohomology is finite-dimensional.

Remark 16.1.7. Actually, Beilinson only considers certain pure motives. The general conjecture is formulated as Conjecture B by [Sch91]. In Definition 6.2.9, we defined motivic cohomology of algebraic varieties. Analogously, we put

$$H_{\mathcal{M}}^i(\mathrm{Spec}(\mathbb{Q}), M) = \mathrm{Hom}_{DM_{\mathrm{gm}}}(M, \mathbb{Q}[i])$$

for all geometric motives M . The unramified motivic cohomology groups $H_{\mathcal{M},f}^1(\mathrm{Spec}(\mathbb{Q}), M)$ are modifications whose definition depends on conjectures about the category of motives over \mathbb{Q} . An unconditional definition for Chow motives was given by Scholl in [Sch07]. For the case of Tate motives, see also Section 6.4. For a conceptual discussion of unramified motivic cohomology and a comparison of the different possible definitions, see Scholbach’s discussion in [Sch12a]. We prefer to treat them as a black box.

This conjecture is known, for example, when $M = H^0(\mathrm{Spec}(K))(n)$ with K a number field, $n \in \mathbb{Z}$ or when $M = H^1(E)$ with E an elliptic curve with Mordell–Weil rank at most 1.

Definition 16.1.8. We call M *special* if the motivic cohomology groups

$$H_{\mathcal{M},f}^0(\mathrm{Spec}(\mathbb{Q}), M), H_{\mathcal{M},f}^1(\mathrm{Spec}(\mathbb{Q}), M), \\ H_{\mathcal{M},f}^0(\mathrm{Spec}(\mathbb{Q}), M^*(1)), H_{\mathcal{M},f}^1(\mathrm{Spec}(\mathbb{Q}), M^*(1))$$

all vanish.

If M is pure and special, then Beilinson’s conjecture on the Beilinson regulator implies that it is also critical in the sense of Deligne, [Del79, Définition 1.3]. The converse is not expected. We are only going to state the Beilinson conjecture for special motives. In the pure case, this is a case of Deligne’s conjecture.

Conjecture 16.1.9 (Beilinson [Beĭ84], Deligne [Del79]). *Let M be a special motive. Let M_B be its Betti realisation and M_{dR} its de Rham realisation.*

1. $L(M, 0)$ is defined and non-zero.
2. The composition

$$M_B^+ \otimes \mathbb{C} \rightarrow M_B \otimes \mathbb{C} \xrightarrow{\mathrm{per}} M_{\mathrm{dR}} \otimes \mathbb{C} \rightarrow M_{\mathrm{dR}} \otimes \mathbb{C} / F^0 M_{\mathrm{dR}} \otimes \mathbb{C}$$

is an isomorphism. Here M_B^+ denotes the invariants under complex conjugation and $F^0 M_{\mathrm{dR}}$ denotes the 0-step of the Hodge filtration.

3. Up to a rational factor, the value $L(M, 0)$ is given by the determinant of the above isomorphism in any choice of rational basis of M_B^+ and M_{dR} .

For the formulation in the general case, which is somewhat involved, see [Fon92], ignoring everything p -adic. The precise formula for $L(M, 0)^*$ is actually implied by the above by asking compatibility with short exact sequences of motives (hence it suffices to consider the pure case) and the following trick.

Proposition 16.1.10 (Scholl, [Sch91]). *Let M be a pure motive. Assume all unramified motivic cohomology groups over \mathbb{Q} are finite-dimensional. Then there is a special mixed motive M' such that*

$$L(M, 0)^* = L(M', 0)$$

and the Beilinson conjecture for M is equivalent to the Beilinson conjecture for M' .

Proof. The case of motives of weight at least 0 is treated in [Sch91, Section IV]. By applying the considerations to $M^*(1)$ this also settles the case of motives with all weights at most -2 . The remaining case of motives of weight -1 is handled in loc. cit. Section V. \square

Corollary 16.1.11. *Assume the Beilinson conjecture holds. Let M be a motive. Then $L(M, 0)^*$ is a period number.*

Proof. We first reduce to the pure case. The L -function is nearly multiplicative on short exact sequences of motives. If $0 \rightarrow M' \rightarrow M \rightarrow M'' \rightarrow 0$ is a short exact sequence of motives, then $P_p(M, t) = P_p(M', t)P_p(M'', t)$ for almost all primes, in fact for all primes where I_p acts trivially on M'_l and M''_l . Hence $L(M, 0)^*$ and $L(M', 0)^*L(M'', 0)^*$ differ by a rational factor.

By Scholl's reduction, it then suffices to consider the case where M is special. The matrix of the morphism in the conjecture is a block in the matrix of

$$\text{per} : M_B \otimes \mathbb{C} \rightarrow M_{\text{dR}} \otimes \mathbb{C}.$$

All its entries are periods. Hence, the same is true for the determinant. \square

16.2 Feynman periods

Standard procedures in quantum field theory (QFT) lead to loop amplitudes associated to certain graphs. Although the foundations of QFT via path integrals are mathematically non-rigorous, Feynman and others have set up the so-called Feynman rules as axioms, leading to a mathematically precise definition of *loop integrals* (sometimes also called amplitudes).

These are defined as follows. Associated to a graph G one defines the integral as

$$I_G = \frac{\prod_{j=1}^n \Gamma(\nu_j)}{\Gamma(\nu - \ell D/2)} \int_{\mathbb{R}^{D\ell}} \frac{\prod_{r=1}^{\ell} dk_r}{i\pi^{D/2}} \prod_{j=1}^n (-q_j^2 + m_j^2)^{-\nu_j}.$$

Here, D is the dimension of space-time (usually, but not always, $D = 4$), n is the number of internal edges of G , $\ell = h_1(G)$ is the loop number, ν_j are integers associated to each edge, ν is the sum of all ν_j , the m_j are masses, the q_j are combinations of external momenta and internal loop momenta k_r , over which one has to integrate [MSWZ14, Section 2]. All occurring squares, except for the squared masses m_j^2 , are scalar products in D -dimensional Minkowski space. The integrals usually do not converge in D -space, but standard renormalisation procedures in physics, e.g. dimensional regularisation, lead to explicit numbers as coefficients of Laurent series. In dimensional regularisation, one views the integrals as analytic meromorphic functions in the parameter $\epsilon \in \mathbb{C}$ where $D = 4 - 2\epsilon$. The coefficients of the resulting Laurent expansion in the variable ϵ are then the relevant numbers. By a theorem of Belkale–Brosnan [BB03] and Bogner–Weinzierl [BW09], such numbers are periods if all moments and masses in the formulas are rational (or, more generally, algebraic) numbers.

A process called the *Feynman–Schwinger trick* [BEK06] transforms the above integral into a period integral

$$I_G = \int_{\sigma} f\omega$$

with

$$f = \frac{\prod_{j=1}^n x_j^{\nu_j-1} \mathcal{U}^{\nu-(\ell+1)D/2}}{\mathcal{F}^{\nu-\ell D/2}}, \quad \omega = \sum_{j=1}^n (-1)^j x_j dx_1 \wedge \cdots \wedge \widehat{dx_j} \wedge \cdots \wedge dx_n.$$

Here, \mathcal{U} and \mathcal{F} are homogenous graph polynomials of Kirchhoff type, with only \mathcal{F} depending on kinematical invariants, and σ is the standard real simplex in $\mathbb{P}^{n-1}(\mathbb{C})$, a compact subset of $\mathbb{P}^{n-1}(\mathbb{C})$. The differential form $f\omega$ may have poles along σ , but there is a canonical blow-up process to resolve this problem [BB03, BEK06]. The period which emerges is a period of the relative cohomology group

$$H^{n-1}(P \setminus Y, B \setminus (B \cap Y)),$$

where P is a blow-up of projective space, Y is the strict transform of the singularity set of the integrand, and B is the strict transform of the standard algebraic simplex $\Delta^{n-1} \subset \mathbb{P}^{n-1}$. Thus, after the blow-up, I_G is a naive period, if it is convergent, and provided that all masses and momenta involved are algebraic numbers. If I_G is not convergent, then, by a theorem of Belkale–Brosnan [BB03] and Bogner–Weinzierl [BW09], the same holds under these assumptions for the coefficients of the Laurent expansion in renormalisation.

Example 16.2.1. A very popular graph with a divergent amplitude is the two-loop sunset graph

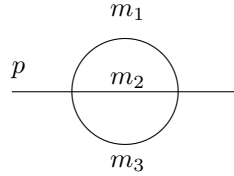

The corresponding amplitude in D dimensions is the product of the Γ -value $\Gamma(3 - D)$ with the period integral

$$\int_{\sigma} \frac{(x_1x_2 + x_2x_3 + x_3x_1)^{3-\frac{3}{2}D} (x_1dx_2 \wedge dx_3 - x_2dx_1 \wedge dx_3 + x_3dx_1 \wedge dx_2)}{(-x_1x_2x_3p^2 + (x_1m_1^2 + x_2m_2^2 + x_3m_3^2)(x_1x_2 + x_2x_3 + x_3x_1))^{3-D}},$$

where σ is the real 2-simplex in \mathbb{P}^2 .

In $D = 4$, this integral does not converge. One may, however, compute the integral in $D = 2$ and study its dependence on the momentum p as an inhomogeneous differential equation, as there is an obvious family of elliptic curves Y_t (for $t = p^2$) involved in the equations of the denominator of the integral which gives rise to a homogenous Picard–Fuchs equation. Then, a trick of Tarasov allows us to compute the $D = 4$ situation from that, see [MSWZ12] for all the details. The extension of mixed Hodge structures

$$0 \rightarrow \mathbb{Z}(-1) \rightarrow H^2(P \setminus Y_t, B \setminus B \cap Y_t) \rightarrow H^2(P \setminus Y_t) \rightarrow 0$$

arising from this graph is already quite complicated, as there are three different weights involved. The corresponding period functions when the momentum p varies are given by elliptic dilogarithm functions [BV15b, ABW14]. There are generalisations to higher loop banana graphs [BKV15].

In the literature, there are many more concrete examples of such periods, see the work of Broadhurst–Kreimer [BK97] and subsequent work. Besides multiple zeta values, there are, for example, graphs G where the integral is related to periods of K3 surfaces [BS12].

16.3 Algebraic cycles and periods

In this section, we want to show how algebraic cycles in (higher) Chow groups give rise to Kontsevich–Zagier periods. Let us start with an example.

Example 16.3.1. Assume that $k \subset \mathbb{C}$, let X be a smooth, projective curve of genus g , and let $Z = \sum_{i=1}^k a_i Z_i \in CH^1(X)$ be a non-trivial zero-cycle on X with degree 0, i.e., $\sum_i a_i = 0$. Then we have a sequence of cohomology

groups with integral coefficients

$$\begin{array}{ccccccc}
 0 & \longrightarrow & H^1(X^{\text{an}}) & \longrightarrow & H^1(X^{\text{an}} \setminus |Z|) & \longrightarrow & H^2_{|Z|}(X^{\text{an}}) & \longrightarrow & H^2(X^{\text{an}}) \\
 & & & & & & \downarrow \cong & & \downarrow \cong \\
 & & & & & & \bigoplus_i \mathbb{Z}(-1) & \xrightarrow{\Sigma} & \mathbb{Z}(-1).
 \end{array}$$

The cycle Z defines a non-zero vector $(a_1, \dots, a_k) \in \bigoplus_i \mathbb{Z}(-1)$ mapping to zero in $H^2(X^{\text{an}}, \mathbb{Z})$. Hence, by pulling back, we obtain an extension

$$0 \rightarrow H^1(X^{\text{an}}) \rightarrow E \rightarrow \mathbb{Z}(-1) \rightarrow 0.$$

The extension class of this sequence in the category of mixed Hodge structures is known to be the *Abel–Jacobi class* of Z , see [Car80]. One can compute it in several ways. For example, one can choose a continuous chain γ with $\partial\gamma = \sum_i a_i Z_i$ and a basis $\omega_1, \dots, \omega_g$ of holomorphic 1-forms on X^{an} . Then the vector

$$\left(\int_{\gamma} \omega_1, \dots, \int_{\gamma} \omega_g \right)$$

defines the Abel–Jacobi class in the *Jacobian*

$$\text{Jac}(X) = \frac{H^1(X^{\text{an}}, \mathbb{C})}{F^1 H^1(X^{\text{an}}, \mathbb{C}) + H^1(X^{\text{an}}, \mathbb{Z})} \cong \frac{H^0(X^{\text{an}}, \Omega^1_{X^{\text{an}}})^\vee}{H_1(X^{\text{an}}, \mathbb{Z})}.$$

If X and the cycle Z are both defined over k , then obviously the Abel–Jacobi class is defined by g period integrals in $\mathbb{P}^{\text{eff}}(k)$. In the case of smooth, projective curves, the Abel–Jacobi map

$$\text{AJ}^1 : CH^1(X)_{\text{hom}} \rightarrow \text{Jac}(X)$$

gives an isomorphism when $k = \mathbb{C}$.

One can generalise this construction to Chow groups of any smooth, projective variety X over $k \subset \mathbb{C}$, and $Z \in CH^q(X)$ a cycle which is homologous to zero. Then there exists the general Abel–Jacobi map

$$\begin{aligned}
 \text{AJ}^q : CH^q(X)_{\text{hom}} &\longrightarrow \frac{H^{2q-1}(X^{\text{an}}, \mathbb{C})}{F^q + H^{2q-1}(X^{\text{an}}, \mathbb{Z})} \\
 &\cong \text{Ext}_{\text{MHS}}^1(\mathbb{Z}(-q), H^{2q-1}(X^{\text{an}}, \mathbb{Z})).
 \end{aligned}$$

As in the example above, the cycle Z defines an extension of mixed Hodge structures

$$0 \rightarrow H^{2q-1}(X^{\text{an}}) \rightarrow E \rightarrow \mathbb{Z}(-q) \rightarrow 0,$$

where E is a subquotient of $H^{2q-1}(X^{\text{an}} \setminus |Z|)$. The Abel–Jacobi class is given by period integrals

$$\left(\int_{\gamma} \omega_1, \dots, \int_{\gamma} \omega_g \right)$$

in Griffiths' intermediate Jacobian

$$\begin{aligned} J^q(X) &= \frac{H^{2q-1}(X^{\text{an}}, \mathbb{C})}{F^q H^{2q-1}(X^{\text{an}}, \mathbb{C}) + H^{2q-1}(X^{\text{an}}, \mathbb{Z})} \\ &\cong \frac{F^q H^{2q-1}(X^{\text{an}}, \mathbb{C})^\vee}{H_{2q-1}(X^{\text{an}}, \mathbb{Z})}. \end{aligned}$$

Even more general, one may use Bloch's *higher Chow groups* $CH^q(X, n)$ [Blo86]. Higher Chow groups are isomorphic to motivic cohomology in the smooth case by a result of Voevodsky, see Theorem 6.2.10. In the general case, they only form a Borel–Moore homology theory and not a cohomology theory, see [VSF00]. Then the Abel–Jacobi map becomes

$$\text{AJ}^{q,n} : CH^q(X, n)_{\text{hom}} \longrightarrow J^{2q-n-1}(X) \cong \text{Ext}_{\text{MHS}}^1(\mathbb{Z}(-q), H^{2q-n-1}(X^{\text{an}}, \mathbb{Z})).$$

There are explicit formulae for $\text{AJ}^{q,n}$ in [KLMS06, KL07, Wei15] on the level of complexes which look like period integrals. This is not a coincidence:

Proposition 16.3.2. *The higher Abel–Jacobi class of an algebraic cycle $Z \in CH^q(X, n)_{\text{hom}}$ is an extension class of a short exact sequence*

$$0 \rightarrow H^{2q-n-1}(X^{\text{an}}) \rightarrow E \rightarrow \mathbb{Z}(-q) \rightarrow 0$$

of mixed Hodge structures, where E is a subquotient of the cohomology of a pair defined over the same field k , i.e., a Nori motive. The extension class is given by period integrals which define numbers in $\mathbb{P}^{\text{eff}}(k)$.

Proof. The statement about the extension class follows directly from the existence of realisation maps [Hub00, KLMS06, DS91, Sch]. The Abel–Jacobi class of a cycle $Z \in CH^q(X, n)_{\text{hom}}$ is then the extension class of a mixed Hodge structure. The periods associated to these mixed Hodge structures over k can hence be viewed as the periods associated to Z .

In addition, we want to give Bloch's description of this extension, which gives an explicit way to construct the short exact sequence.

Let $\square^n := (\mathbb{P}^1 \setminus \{1\})^n$. For varying n , this defines a cosimplicial object with face and degeneracy maps obtained by using the natural coordinate t on \mathbb{P}^1 . Faces are given by setting $t_i = 0$ or $t_i = \infty$. By definition, a cycle Z in a higher Chow group $CH^q(X, n)$ is a subvariety of $X \times \square^n$ meeting all faces $F = X \times \square^m \subset X \times \square^n$ for $m < n$ properly, i.e., in codimension q . By looking at the normalised cycle complex, we may assume that Z has zero intersection with all faces of $X \times \square^n$. Removing the support of Z , let $U := X \times \square^n \setminus |Z|$, and define ∂U to be the union of the intersection of U with the codimension 1 faces of $X \times \square^n$. Then one obtains an exact sequence [DS91, Lemma A.2]

$$0 \rightarrow H^{2q-n-1}(X^{\text{an}}) \rightarrow H^{2q-1}(U^{\text{an}}, \partial U^{\text{an}}) \rightarrow H^{2q-1}(U^{\text{an}}) \rightarrow H^{2q-1}(\partial U^{\text{an}}),$$

which can be pulled back to an extension E if Z is homologous to zero:

$$0 \rightarrow H^{2q-n-1}(X^{\text{an}}) \rightarrow E \rightarrow \mathbb{Z}(-q) \rightarrow 0.$$

Hence, E is a subquotient of the mixed Hodge structure $H^{2q-1}(U^{\text{an}}, \partial U^{\text{an}})$. This works for any cohomology satisfying certain axioms, see [DS91]. \square

In particular, we obtain a Nori motive, also denoted by E , which is associated to every cycle $Z \in CH^q(X, n)_{\text{hom}}$ over k .

There is an alternative description of the Abel–Jacobi map using the full motivic machine. It also yields an alternative proof of the proposition. We work in the setting of geometric motives, see Section 6.2. Let X be a smooth variety. By Theorem 6.2.10 we have

$$CH^q(X, n) \cong H^{n-2q}(X, \mathbb{Z}(q)) = \text{Hom}_{DM_{\text{gm}}}(M(X), \mathbb{Z}(q)[n-2q]).$$

We apply the realisation functor to the derived category of Nori motives of Theorem 10.1.4 and obtain

$$\begin{aligned} Ch^q(X, n) &\rightarrow \text{Hom}_{D^b(\mathcal{MM}_{\text{Nori}})}(\mathbf{1}(-q)[2q-n], C(X)) \\ &= \text{Hom}_{D^b(\mathcal{MM}_{\text{Nori}})}(\mathbf{1}(-q)[2q-n], \tau_{\leq n-2q} C(X)). \end{aligned}$$

A cycle is homologically trivial if and only if the induced map to the motive $H_{\mathcal{MM}_{\text{Nori}}}^{2n-q}(X)$ vanishes. Hence we get a secondary map

$$\begin{aligned} CH^q(X, n)_{\text{hom}} &\rightarrow \text{Hom}_{D^b(\mathcal{MM}_{\text{Nori}})}(\mathbf{1}(-q), \tau_{\leq n-2q-1} C(X)) \\ &\rightarrow \text{Ext}_{\mathcal{MM}_{\text{Nori}}}^1(\mathbf{1}(-q), H^{2n-q-1}(X)). \end{aligned}$$

By construction, the composition of this map with the Hodge realisation is nothing but $AJ^{q,n}$.

Second proof of Proposition 16.3.2. The Abel–Jacobi map factors via extensions of Nori motives. In particular, the Hodge structure E is induced by a Nori motive. Its periods are in $\mathbb{P}^{\text{eff}}(k)$. \square

Remark 16.3.3. For the category of Nori motives, extension groups are not known in general, and have only been computed in the case of effective 1-motives, see [ABV15]. The extension groups of the conjectural \mathbb{Q} -linear abelian category $\text{MM}(k)$ of mixed motives over k are supposed to be related to motivic cohomology groups, or, equivalently to be Adams eigenspaces of algebraic K -groups.

Following Beilinson, we expect a spectral sequence

$$\text{Ext}_{\mathcal{MM}(k)}^i(\mathbb{Q}(-q), H^j(X)) \Rightarrow H_{\mathcal{M}}^{i+j}(X, \mathbb{Q}(q)) = \text{Hom}_{DM_{\text{gm}}}(M(X), \mathbb{Q}(q)[i+j]).$$

If X is smooth, then we have by Theorem 6.2.10

$$H_{\mathcal{M}}^{i+j}(X, \mathbb{Q}(q)) \cong K_{2q-i-j}(X)_{\mathbb{Q}}^{(q)} = CH^q(X, 2q-i-j)_{\mathbb{Q}}.$$

If k is a number field, then $\mathcal{M}\mathcal{M}(k)$ is expected to have cohomological dimension 1, and the spectral sequence collapses into the short exact sequence

$$\begin{aligned} 0 \rightarrow \text{Ext}_{\mathcal{M}\mathcal{M}(k)}^1(\mathbb{Q}(-q), H^{n-1}(X)) &\rightarrow H_M^n(X, \mathbb{Q}(q)) \\ &\rightarrow \text{Hom}_{\mathcal{M}\mathcal{M}(k)}(\mathbb{Q}(-q), H^n(X)) \rightarrow 0. \end{aligned}$$

In many cases, the last group vanishes, e.g., if X is smooth projective and $q \neq 2n$. If $X = \text{Spec}(k)$ is the spectrum of a number field, then the above gives (conjectural) isomorphisms

$$\text{Ext}_{\mathcal{M}\mathcal{M}(k)}^1(\mathbb{Q}(-q), \mathbb{Q}) \cong K_{2q-1}(k)_{\mathbb{Q}}^{(q)} = K_{2q-1}(k)_{\mathbb{Q}}$$

for all q . Note that this isomorphism is indeed true in the category of mixed Tate motives, see Section 6.4. In this case, the Abel–Jacobi map can be identified with the Borel regulator (at least up to a factor of 2). Hence Borel’s computation in [Bor77] can be seen as a period computation. His main result is that for $q \geq 2$, the determinant of the period matrix is given by the values of the Dedekind zeta function $\zeta_K(q)$, at least up to a factor in \mathbb{Q} . This is a special case of the Beilinson conjecture, see also Section 16.1.

16.4 Periods of homotopy groups

In this section, we want to explain the periods associated to fundamental groups and higher homotopy groups.

The topological fundamental group $\pi_1^{\text{top}}(X(\mathbb{C}), a)$ of an algebraic variety X (defined over $k \subset \mathbb{C}$) with base point a carries a mixed Hodge structure in the following sense.

First, look at the group algebra $\mathbb{Q}[\pi_1^{\text{top}}(X(\mathbb{C}), a)]$, and the augmentation ideal $I := \text{Ker}(\mathbb{Q}[\pi_1^{\text{top}}(X, a)] \rightarrow \mathbb{Q})$. Then the Malcev-type object

$$\hat{\pi}_1(X(\mathbb{C}), a)_{\mathbb{Q}} := \lim_{n \rightarrow \infty} \mathbb{Q}[\pi_1^{\text{top}}(X(\mathbb{C}), a)]/I^{n+1}$$

carry an Ind-MHS, as we will explain now. Beilinson observed that each finite step $\mathbb{Q}[\pi_1^{\text{top}}(X(\mathbb{C}), a)]/I^{n+1}$ can be obtained as the mixed Hodge structure of a certain algebraic variety defined over the same field k . This was known to experts for some time, and later worked out in [DG05].

Theorem 16.4.1. *Let M be any connected complex manifold and $a \in M$ a point. Then there is an isomorphism*

$$H_n(\underbrace{M \times \cdots \times M}_n, D; \mathbb{Q}) \cong \mathbb{Q}_{a,a} \oplus \mathbb{Q}[\pi_1^{\text{top}}(M, a)]/I^{n+1},$$

and $H_k(\underbrace{M \times \cdots \times M}_n, D; \mathbb{Q}) = 0$ for $k < n$. Here $D = \bigcup_{i=0}^n D_i$ is a union of irreducible subsets, where $D_0 = \{a\} \times M^{n-1}$, $D_n = M^{n-1} \times \{a\}$, and, for $1 \leq i \leq n-1$, $D_i = M^{i-1} \times \Delta \times M^{n-i-1}$ with $\Delta \subset M \times M$ the diagonal.

Proof. The proof in [DG05], which we will not give here, proceeds by induction, using the first projection $p_1 : M^n \rightarrow M$ and the Leray spectral sequence. □

This is applied in the case where $M = X(\mathbb{C})$ for some variety X , such that its motive is mixed Tate. The primary example is $X = \mathbb{P}^1 \setminus \{0, 1, \infty\}$. In the framework of Nori motives, one can thus see that $\hat{\pi}_1(X, a)_{\mathbb{Q}}$ immediately carries the structure of an Ind-Nori motive over k .

Furthermore, one needs to pass to tangential base points at 0 and 1, denoted by $\overrightarrow{01}$, instead of a base point a as above, to obtain interesting results. Then it is true that $\hat{\pi}_1(\mathbb{P}^1 \setminus \{0, 1, \infty\}, \overrightarrow{01})_{\mathbb{Q}}$ is an Ind-mixed Tate motive over \mathbb{Q} (in fact, unramified over \mathbb{Z}), and it generates the whole category of mixed Tate motives unramified over \mathbb{Z} . In particular, each MZV occurs as a period of this Ind-MHS by results of Brown [Bro12, Bro14]:

Theorem 16.4.2 (Brown). *Every multiple zeta value occurs as a period of $\hat{\pi}_1(\mathbb{P}^1 \setminus \{0, 1, \infty\}, \overrightarrow{01})_{\mathbb{Q}}$. Furthermore, every multiple zeta value is a \mathbb{Q} -linear combination of multiple zeta values with only 2 and 3 as entries.*

We cannot give a complete proof of this fact here. But these results are nicely explained in Deligne’s Bourbaki article [Del13, Corollaire 7.18]: The proof uses the precise knowledge of the infinitesimal action of the motivic Galois group. See [Bro12, Bro14, Del13].

Let us now look at higher homotopy groups $\pi_n(X^{\text{an}})$ for $n \geq 2$ of an algebraic variety X over $k \subset \mathbb{C}$. They carry a \mathbb{Q} -MHS by a theorem of Morgan [Mor78] and Hain [Hai94]:

Theorem 16.4.3. *The homotopy groups $\pi_n(X^{\text{an}}) \otimes \mathbb{Q}$ of a simply connected and smooth projective variety over \mathbb{C} carry a functorial mixed Hodge structure for $n \geq 2$.*

This theorem has a natural extension to the non-compact case using logarithmic forms, and to the singular case using cubical hyperresolutions, see [Hai94, NA85, PS08].

Example 16.4.4. Let X be a simply connected, smooth projective 3-fold over \mathbb{C} . Then the MHS on $\pi_3(X^{\text{an}})^{\vee}$ is given by an extension

$$\begin{aligned} 0 \rightarrow H^3(X^{\text{an}}, \mathbb{Q}) \rightarrow \text{Hom}(\pi_3(X^{\text{an}}), \mathbb{Q}) \\ \rightarrow \text{Ker}(S^2 H^2(X^{\text{an}}, \mathbb{Q}) \rightarrow H^4(X^{\text{an}}, \mathbb{Q})) \rightarrow 0, \end{aligned}$$

constructed using the Postnikov tower by Carlson, Clemens, and Morgan in [CCM81]. The authors prove that this extension is given by the Abel–Jacobi class of a certain codimension 2 cycle $Z \in CH_{\text{hom}}^2(X)$, and the extension class of this MHS in the sense of [Car80] is given by the Abel–Jacobi class

$$\text{AJ}^2(Z) \in J^2(X) = \frac{H^3(X^{\text{an}}, \mathbb{C})}{F^2 + H^3(X^{\text{an}}, \mathbb{Z})}.$$

Morgan’s proof uses the theory of Quillen [Qui69] and Sullivan [Sul77] on rational homotopy theory. Let us sketch this description. In the simply connected case, there is a differential graded Lie algebra $L(X, x)$ over \mathbb{Q} , concentrated in degrees 0, -1 , ..., such that

$$H_*(L(X, x)) \cong \pi_{*+1}(X^{\text{an}}) \otimes \mathbb{Q}.$$

One can then use the cohomological description of $L(X, x)$ and Deligne’s mixed Hodge theory, to define the MHS on homotopy groups using a complex defined over k .

We would like to mention that one can try to make this construction motivic in the Nori sense. At least for affine varieties, this was done in [Gar03], see also [CGAdS14, pg. 22]. In [Gon10], a description of periods of homotopy groups is given in terms of Hodge correlators. This is not well understood yet. Patel has looked at complements of hyperplane arrangements [Pat15].

From the approach in [Gar03], one can see, at least in the affine case, that the periods of the MHS on $\pi_n(X^{\text{an}})$ are defined over k , i.e., are contained in $\mathbb{P}^{\text{eff}}(k)$, when X is defined over k , since all motives involved in the construction are defined over k .

16.5 Exponential periods

Kontsevich and Zagier [KZ01, Kon99] have suggested to study exponential period numbers, i.e., integrals of the form

$$\int_{\gamma} e^{-f} \omega.$$

In the most basic setup, ω is an algebraic differential form over \mathbb{Q} of degree k on a variety X defined over \mathbb{Q} , f a regular function on X , and γ a topological k -chain. In order for the integral to converge, one must require that γ has boundary in a region where $\exp(-f)$ decays fast enough. The \mathbb{Q} -algebra of all such exponential period numbers includes the set of Kontsevich–Zagier periods with $f = 0$, but also many other constants which are presumably not Kontsevich–Zagier period numbers, like the Euler number e , values of the Γ -function at all rational arguments, and certain values of Bessel functions.

One can view such numbers as the set of periods of a *new* kind of “Hodge structures”, including the example of a Hodge structure of weight $(\frac{1}{2}, \frac{1}{2})$, i.e., a square root of the Tate Hodge structure $\mathbb{Q}(-1)$ with exponential period

$$\sqrt{\pi} = \int_{-\infty}^{+\infty} e^{-x^2} dx.$$

More functorially, the exponential Hodge structures $H^\bullet(X, f)$ have de Rham realisation $H_{\text{dR}}^\bullet(X, f)$ the (hyper)cohomology of the twisted de Rham complex

$$\Omega_{X/\mathbb{Q}, f}^\bullet : \cdots \longrightarrow \Omega_{X/\mathbb{Q}}^{p-1} \xrightarrow{d+\wedge df} \Omega_{X/\mathbb{Q}}^p \longrightarrow \cdots$$

and the Betti realisation $H_{\text{B}}^\bullet(X, f)$ of Deligne [Del06, pg. 116], defined as the cohomology of a certain constructible sheaf that is constructed using growth conditions for f . Sabbah [Sab96] has shown that

$$H_{\text{B}}^\bullet(X, f) = H_{\text{sing}}^\bullet(X, f^{-1}(t); \mathbb{Q})$$

for $t \in \mathbb{A}^1(\mathbb{C})$ with $\text{Re}(t) \gg 0$. If one has $\omega \in H_{\text{dR}}^d(X)$ with $d = \dim(X)$ and $\gamma_t \in H_d(X, f^{-1}(t); \mathbb{Q})$ (the dual space), then the period of (X, f) is obtained as a limit

$$\lim_{t \rightarrow \infty} \int_{\gamma_t} e^{-f} \omega.$$

Presumably, there exists a Tannakian category of *exponential Nori motives* $H^i(X, Y; f)$ over \mathbb{Q} which can be constructed with the methods of Nori used in this book by an adaption of the basic lemma. The details are currently being worked out by Fresán and Jossen [FJ16]. The tensor structure and rigidity (i.e., duality) were already described in [Del06]. Exponential periods would then appear as the matrix entries of the period isomorphism [Del06, pg. 116], [Sab96]

$$H_{\text{dR}}^\bullet(X, Y, f) \otimes_{\mathbb{Q}} \mathbb{C} \longrightarrow H_{\text{B}}^\bullet(X, Y, f) \otimes_{\mathbb{Q}} \mathbb{C},$$

by considering suitable triples (X, Y, f) , where Y is a closed subset.

16.6 Non-periods

The question, whether a given transcendental complex number is a period number in $\mathbb{P}^{\text{eff}}(\mathbb{Q})$, i.e., is a Kontsevich–Zagier period, is very difficult to answer in general, even though we know that there are only countably many of them. For example, we expect (but do not know) that the Euler number e is not a period. Also $1/\pi$ and Euler’s γ are presumably not effective periods, although no proof is known.

When Kontsevich–Zagier wrote their paper, the situation was similar to that at the beginning of the 19th century for the study of algebraic and transcendental numbers. It took a lot of effort to prove that Liouville numbers $\sum_i 10^{-i!}$, e (Hermite) and π (Lindemann) were transcendental.

In 2008, M. Yoshinaga [Yos08] first wrote down a non-period

$$\alpha = 0.77766444\dots$$

in 3-adic expansion

$$\alpha = \sum_{i=1}^{\infty} \epsilon_i 3^{-i}.$$

We will now explain how to define this number, and why it is not a period. First, we have to explain the notions of computable and elementary computable numbers.

Computable numbers and equivalent notions of computable (i.e., equivalently, partial recursive) functions $f : \mathbb{N}_0^n \rightarrow \mathbb{N}_0$ were introduced by Turing [Tur36], Kleene and Church around 1936 following ideas built on Dedekind’s recursion theorem, see the references in [Kle81]. We refer to [Bri94] for a modern treatment of such notions which is intended for mathematicians.

The modern theory of computable functions starts with the notion of certain classes \mathcal{E} of functions $f : \mathbb{N}_0 \rightarrow \mathbb{N}_0$. For each class \mathcal{E} there is then a notion of \mathcal{E} -computable real numbers. In the following definition we follow [Yos08], but this was defined much earlier, see for example [Ric54, Spe49].

Definition 16.6.1. A real number $\alpha > 0$ is called \mathcal{E} -computable if there are functions a, b, c in \mathcal{E} such that

$$\left| \frac{a(n)}{b(n) + 1} - \alpha \right| < \frac{1}{k}, \text{ for all } n \geq c(k).$$

The set of \mathcal{E} -computable numbers, including 0 and closed under $\alpha \mapsto -\alpha$, is denoted by $\mathbb{R}_{\mathcal{E}}$.

Some authors use the bound 2^{-k} instead of $\frac{1}{k}$. This leads to an equivalent notion only for classes \mathcal{E} which are closed under substitution (i.e., composition) and contain the function $n \mapsto 2^n$.

If $\mathcal{E} = \text{comp}$ is the class of *Turing computable* [Tur36], or equivalently Kleene’s *partial recursive functions* [Kle81], then \mathbb{R}_{comp} is the set of *computable real numbers*. Computable complex numbers \mathbb{C}_{comp} are those complex numbers where the real- and imaginary part are computable reals.

Theorem 16.6.2. \mathbb{R}_{comp} is a countable subfield of \mathbb{R} , and $\mathbb{C}_{\text{comp}} = \mathbb{R}_{\text{comp}}(i)$ is algebraically closed.

One can think of computable numbers as the set of all numbers that can be accessed with a computer.

There are some important levels of hierarchies inside the set of computable reals

$$\mathbb{R}_{\text{low-elem}} \subsetneq \mathbb{R}_{\text{elem}} \subsetneq \mathbb{R}_{\text{comp}},$$

induced by the elementary functions of Kalmár (1943) [Kal43], and the lower elementary functions of Skolem (1962) [Sko62]. There is also the related Grzegorzcyk hierarchy [Grz55]. In order to define such hierarchies of real numbers, we will now study functions $f : \mathbb{N}_0^n \rightarrow \mathbb{N}_0$ of several variables.

Definition 16.6.3. The class of *lower-elementary functions* is the smallest class of functions $f : \mathbb{N}_0^n \rightarrow \mathbb{N}_0$

- containing the zero-function, the successor function $x \mapsto x + 1$ and the projection function $P_i : (x_1, \dots, x_n) \mapsto x_i$,
- containing the addition $x + y$, the multiplication $x \cdot y$, and the modified subtraction $\max(x - y, 0)$,
- closed under composition, and
- closed under bounded summation.

The class of *elementary functions* is the smallest class which is also closed under bounded products.

Here, bounded summation (resp. product) is defined as

$$g(x, x_1, \dots, x_n) = \sum_{a \leq x} f(a, x_1, \dots, x_n) \text{ resp. } \prod_{a \leq x} f(a, x_1, \dots, x_n).$$

Elementary functions contain exponentials 2^n , whereas lower elementary function do not. The inclusions in the above hierarchy are strict, see [TZ10].

The main result about periods proven in [Yos08, TZ10] is:

Theorem 16.6.4. *Real periods are lower elementary real numbers.*

In fact, Yoshinaga proved that periods are elementary computable numbers, and Tent–Ziegler made the refinement that periods are even lower-elementary numbers. The proofs are based on Hironaka’s theorem on semi-algebraic sets, which we have already used in Chapter 2. The main idea is to reduce periods to volumes of bounded semi-algebraic sets, and then use Riemann sums to approximate the volumes inside the class of lower elementary computable functions.

Corollary 16.6.5. *One has the inclusions:*

$$\bar{\mathbb{Q}} \subsetneq \mathbb{P}^{\text{eff}}(\mathbb{Q}) \subset \mathbb{C}_{\text{low-elem}} \subsetneq \mathbb{C}_{\text{elem}} \subsetneq \mathbb{C}_{\text{comp}}.$$

Hence, in order to construct a non-period, one needs to exhibit a computable number which is not elementary computable. By Tent–Ziegler, it would also be enough to write down an elementary computable number which is not lower elementary.

Here is how Yoshinaga proceeds. First, using a result of Mazzanti [Maz02], one can show that elementary functions are generated by composition from the following functions:

- The successor function $x \mapsto x + 1$,
- the modified subtraction $\max(x - y, 0)$,
- the floor quotient $(x, y) \mapsto \lfloor \frac{x}{y+1} \rfloor$, and
- the exponential function $(x, y) \mapsto x^y$.

Using this, there is an explicit enumeration $(f_n)_{n \in \mathbb{N}_0}$ of all elementary functions $f : \mathbb{N}_0 \rightarrow \mathbb{N}_0$. Together with the standard enumeration of $\mathbb{Q}_{>0}$, we obtain an explicit enumeration $(g_n)_{n \in \mathbb{N}_0}$ of all elementary maps $g : \mathbb{N}_0 \rightarrow \mathbb{Q}_{>0}$. Using a trick, see [Yos08, pg. 9], one can speed up each function g_n , so that $g_n(m)$ is a Cauchy sequence (hence, convergent) in m for each n .

Following [Yos08], we therefore obtain

$$\mathbb{R}_{\text{elem}} = \{\beta_0, \beta_1, \dots\}, \text{ where } \beta_n = \lim_{m \rightarrow \infty} g_n(m).$$

Finally, Yoshinaga defines

$$\alpha := \lim_{n \rightarrow \infty} \alpha_n = \lim_{n \rightarrow \infty} \sum_{i=1}^n \epsilon_i 3^{-i},$$

where $\epsilon_0 = 0$, and recursively

$$\epsilon_{n+1} := \begin{cases} 0, & \text{if } g_n(n) > \alpha_n + \frac{1}{2 \cdot 3^n} \\ 1, & \text{if } g_n(n) \leq \alpha_n + \frac{1}{2 \cdot 3^n} \end{cases}.$$

Now, it is quite easy to show that α does not occur in the list $\mathbb{R}_{\text{elem}} = \{\beta_0, \beta_1, \dots\}$, see [Yos08, Prop. 17]. Note that the proof is essentially a version of Cantor's diagonal argument.

References

- ABV15. J. Ayoub and L. Barbieri-Viale. Nori 1-motives. *Math. Ann.*, 361(1-2):367–402, 2015.
- ABW14. L. Adams, C. Bogner, and S. Weinzierl. The two-loop sunrise graph in two space-time dimensions with arbitrary masses in terms of elliptic dilogarithms. *J. Math. Phys.*, 55(10):102301, 17, 2014.
- Aep57. A. Aeppli. Modifikation von reellen und komplexen Mannigfaltigkeiten. *Comment. Math. Helv.*, 31:219–301, 1957.
- AF59. A. Andreotti and T. Frankel. The Lefschetz theorem on hyperplane sections. *Ann. of Math. (2)*, 69:713–717, 1959.
- AGV72. M. Artin, A. Grothendieck, and J. L. Verdier. *Théorie des topos et cohomologie étale des schémas. Tome 2*, volume 270 of *Lecture Notes in Mathematics*. Springer-Verlag, Berlin-New York, 1972. Séminaire de Géométrie Algébrique du Bois-Marie 1963–1964 (SGA 4), Dirigé par M. Artin, A. Grothendieck et J. L. Verdier. Avec la collaboration de N. Bourbaki, P. Deligne et B. Saint-Donat.
- AK11. D. Arapura and S.-J. Kang. Kähler-de Rham cohomology and Chern classes. *Comm. Algebra*, 39(4):1153–1167, 2011.
- AM69. M. Artin and B. Mazur. *Étale homotopy*. Lecture Notes in Mathematics, No. 100. Springer-Verlag, Berlin-New York, 1969.
- And96. Y. André. Pour une théorie inconditionnelle des motifs. *Inst. Hautes Études Sci. Publ. Math.*, 83:5–49, 1996.
- And04. Y. André. *Une introduction aux motifs (motifs purs, motifs mixtes, périodes)*, volume 17 of *Panoramas et Synthèses [Panoramas and Syntheses]*. Société Mathématique de France, Paris, 2004.
- And09. Y. André. Galois theory, motives and transcendental numbers. In *Renormalization and Galois theories*, volume 15 of *IRMA Lect. Math. Theor. Phys.*, pages 165–177. Eur. Math. Soc., Zürich, 2009.
- Ara13. D. Arapura. An abelian category of motivic sheaves. *Adv. Math.*, 233:135–195, 2013.
- Arn90. V. I. Arnol'd. *Huygens and Barrow, Newton and Hooke*. Birkhäuser Verlag, Basel, 1990. Pioneers in mathematical analysis and catastrophe theory from evolvents to quasicrystals, Translated from the Russian by Eric J. F. Primrose.
- Art73. M. Artin. Exposé XIV: Théorème de finitude pour un morphisme propre; dimension cohomologique des schémas algébriques affines. In *Théorie des topos et cohomologie étale des schémas. (SGA 4) Tome 3*, volume 305 of *Lecture Notes in Mathematics*, pages 145–168. Springer-Verlag, Berlin-New York, 1973. SGA 4), Dirigé par M. Artin, A. Grothendieck et J. L. Verdier. Avec la collaboration de P. Deligne et B. Saint-Donat.

- Ayo14. J. Ayoub. Periods and the conjectures of Grothendieck and Kontsevich-Zagier. *Eur. Math. Soc. Newsl.*, 91:12–18, 2014.
- Ayo15. J. Ayoub. Une version relative de la conjecture des périodes de Kontsevich-Zagier. *Ann. of Math. (2)*, 181(3):905–992, 2015.
- Ayo16. J. Ayoub. La version relative de la conjecture des périodes de Kontsevich-Zagier revisitée, 2016. Preprint on author’s webpage.
- Bae29. R. Baer. Zur Einführung des Scharbegriffs. *J. Reine Angew. Math.*, 160:199–207, 1929.
- BB03. P. Belkale and P. Brosnan. Periods and Igusa local zeta functions. *Int. Math. Res. Not.*, 49:2655–2670, 2003.
- BBD82. A. A. Beilinson, J. Bernstein, and P. Deligne. Faisceaux pervers. In *Analysis and topology on singular spaces, I (Luminy, 1981)*, volume 100 of *Astérisque*, pages 5–171. Soc. Math. France, Paris, 1982.
- BBV10. J. Blümlein, D. J. Broadhurst, and J. A. M. Vermaseren. The multiple zeta value data mine. *Comput. Phys. Comm.*, 181(3):582–625, 2010.
- BC16. J.-B. Bost and F. Charles. Some remarks concerning the Grothendieck period conjecture. *J. Reine Angew. Math.*, 714:175–208, 2016.
- BCR98. Jacek Bochnak, Michel Coste, and Marie-Françoise Roy. *Real algebraic geometry*, volume 36 of *Ergebnisse der Mathematik und ihrer Grenzgebiete (3) [Results in Mathematics and Related Areas (3)]*. Springer-Verlag, Berlin, 1998. Translated from the 1987 French original, Revised by the authors.
- Bei84. A. A. Beilinson. Higher regulators and values of L -functions. In *Current problems in mathematics, Vol. 24, Itogi Nauki i Tekhniki*, pages 181–238. Akad. Nauk SSSR, Vsesoyuz. Inst. Nauchn. i Tekhn. Inform., Moscow, 1984.
- Bei86. A. A. Beilinson. Notes on absolute Hodge cohomology. In *Applications of algebraic K -theory to algebraic geometry and number theory, Part I, II (Boulder, Colo., 1983)*, volume 55 of *Contemp. Math.*, pages 35–68. Amer. Math. Soc., Providence, RI, 1986.
- Bei87. A. A. Beilinson. On the derived category of perverse sheaves. In *K -theory, arithmetic and geometry (Moscow, 1984–1986)*, volume 1289 of *Lecture Notes in Math.*, pages 27–41. Springer, Berlin, 1987.
- BEK06. S. Bloch, H. Esnault, and D. Kreimer. On motives associated to graph polynomials. *Comm. Math. Phys.*, 267(1):181–225, 2006.
- BG02. J. I. Burgos Gil. *The regulators of Beilinson and Borel*, volume 15 of *CRM Monograph Series*. American Mathematical Society, Providence, RI, 2002.
- BGF. J.I. Burgos Gil and J. Fresán. Multiple zeta values: from numbers to motives. To appear in Clay Math. Proceedings.
- BK97. D. J. Broadhurst and D. Kreimer. Association of multiple zeta values with positive knots via Feynman diagrams up to 9 loops. *Phys. Lett. B*, 393(3-4):403–412, 1997.
- BKV15. S. Bloch, M. Kerr, and P. Vanhove. A Feynman integral via higher normal functions. *Compos. Math.*, 151(12):2329–2375, 2015.
- BL11. F. Brown and A. Levin. Multiple elliptic polylogarithms, 2011. Preprint arXiv:1110.6917.
- Blo86. S. Bloch. Algebraic cycles and higher K -theory. *Adv. in Math.*, 61(3):267–304, 1986.
- Blo94. S. Bloch. The moving lemma for higher Chow groups. *J. Algebraic Geom.*, 3(3):537–568, 1994.
- BLR90. S. Bosch, W. Lütkebohmert, and M. Raynaud. *Néron models*, volume 21 of *Ergebnisse der Mathematik und ihrer Grenzgebiete (3) [Results in Mathematics and Related Areas (3)]*. Springer-Verlag, Berlin, 1990.
- Bon10. M. V. Bondarko. Weight structures vs. t -structures; weight filtrations, spectral sequences, and complexes (for motives and in general). *J. K-Theory*, 6(3):387–504, 2010.

- Bor74. A. Borel. Stable real cohomology of arithmetic groups. *Ann. Sci. École Norm. Sup. (4)*, 7:235–272 (1975), 1974.
- Bor77. A. Borel. Cohomologie de SL_n et valeurs de fonctions zeta aux points entiers. *Ann. Scuola Norm. Sup. Pisa Cl. Sci. (4)*, 4(4):613–636, 1977.
- Bri94. D. S. Bridges. *Computability*, volume 146 of *Graduate Texts in Mathematics*. Springer-Verlag, New York, 1994. A mathematical sketchbook.
- Bro09. F. C. S. Brown. Multiple zeta values and periods of moduli spaces $\overline{\mathcal{M}}_{0,n}$. *Ann. Sci. Éc. Norm. Supér. (4)*, 42(3):371–489, 2009.
- Bro12. F. Brown. Mixed Tate motives over \mathbb{Z} . *Ann. of Math. (2)*, 175(2):949–976, 2012.
- Bro14. F. Brown. Motivic periods and $\mathbb{P}^1 \setminus \{0, 1, \infty\}$, 2014. Proceedings of the ICM Seoul 2014, see arXiv:1407.5165.
- Bru13. J. H. Bruinier. Harmonic Maass forms and periods. *Math. Ann.*, 357(4):1363–1387, 2013.
- BS12. F. Brown and O. Schnetz. A K3 in ϕ^4 . *Duke Math. J.*, 161(10):1817–1862, 2012.
- BV15a. L. Barbieri-Viale. T-motives, 2015. Preprint arXiv:1602.05053.
- BV15b. S. Bloch and P. Vanhove. The elliptic dilogarithm for the sunset graph. *J. Number Theory*, 148:328–364, 2015.
- BVCL15. L. Barbieri-Viale, O. Caramello, and L. Lafforgue. Syntactic categories for nori motives, 2015. Preprint arXiv:1506.06113.
- BVP16. L. Barbieri-Viale and M. Prest. Definable categories and t-motives, 2016. Preprint arXiv:1604.00153.
- BW07. A. Baker and G. Wüstholz. *Logarithmic forms and Diophantine geometry*, volume 9 of *New Mathematical Monographs*. Cambridge University Press, Cambridge, 2007.
- BW09. C. Bogner and S. Weinzierl. Periods and Feynman integrals. *J. Math. Phys.*, 50(4):042302, 16, 2009.
- Car80. J. A. Carlson. Extensions of mixed Hodge structures. In *Journées de Géométrie Algébrique d’Angers, Juillet 1979/Algebraic Geometry, Angers, 1979*, pages 107–127. Sijthoff & Noordhoff, Alphen aan den Rijn—Germantown, Md., 1980.
- CCM81. J. Carlson, H. Clemens, and J. Morgan. On the mixed Hodge structure associated to π_3 of a simply connected complex projective manifold. *Ann. Sci. École Norm. Sup. (4)*, 14(3):323–338, 1981.
- CGAdS14. U. Choudhury and M. Gallauer Alvez de Souza. An isomorphism of motivic galois groups, 2014. Preprint arXiv:1410.6104.
- Cho12. U. Choudhury. Motives of Deligne-Mumford stacks. *Adv. Math.*, 231(6):3094–3117, 2012.
- Chu80. G. V. Chudnovsky. Algebraic independence of values of exponential and elliptic functions. In *Proceedings of the International Congress of Mathematicians (Helsinki, 1978)*, pages 339–350. Acad. Sci. Fennica, Helsinki, 1980.
- CNM15. P. Cassou-Nogès and B. Morin. Tannakian twists of quadratic forms and orthogonal nori motives, 2015. Preprint arXiv:1511.03022.
- CS49. S. Chowla and A. Selberg. On Epstein’s zeta function. I. *Proc. Nat. Acad. Sci. U. S. A.*, 35:371–374, 1949.
- Del71. P. Deligne. Théorie de Hodge. II. *Inst. Hautes Études Sci. Publ. Math.*, 40:5–57, 1971.
- Del74a. P. Deligne. La conjecture de Weil. I. *Inst. Hautes Études Sci. Publ. Math.*, 43:273–307, 1974.
- Del74b. P. Deligne. Théorie de Hodge. III. *Inst. Hautes Études Sci. Publ. Math.*, 44:5–77, 1974.
- Del77. P. Deligne. *Cohomologie étale*. Lecture Notes in Mathematics, Vol. 569. Springer-Verlag, Berlin-New York, 1977. Séminaire de Géométrie Algébrique du Bois-Marie SGA 41øer2, Avec la collaboration de J. F. Boutot, A. Grothendieck, L. Illusie et J. L. Verdier.

- Del79. P. Deligne. Valeurs de fonctions L et périodes d'intégrales. In *Automorphic forms, representations and L-functions (Proc. Sympos. Pure Math., Oregon State Univ., Corvallis, Ore., 1977), Part 2*, Proc. Sympos. Pure Math., XXXIII, pages 313–346. Amer. Math. Soc., Providence, R.I., 1979. With an appendix by N. Koblitz and A. Ogus.
- Del80. P. Deligne. La conjecture de Weil. II. *Inst. Hautes Études Sci. Publ. Math.*, 52:137–252, 1980.
- Del06. P. Deligne. Théorie de hodge irrégulière. *Document Mathématiques*, 5:115–128, 2006.
- Del13. P. Deligne. Multizétas, d'après Francis Brown. *Astérisque*, 352:Exp. No. 1048, viii, 161–185, 2013. Séminaire Bourbaki. Vol. 2011/2012. Exposés 1043–1058.
- DG05. P. Deligne and A. B. Goncharov. Groupes fondamentaux motiviques de Tate mixte. *Ann. Sci. École Norm. Sup. (4)*, 38(1):1–56, 2005.
- dJ96. A. J. de Jong. Smoothness, semi-stability and alterations. *Inst. Hautes Études Sci. Publ. Math.*, 83:51–93, 1996.
- DM82. P. Deligne and J. Milne. Tannakian categories. In Pierre Deligne, James S. Milne, Arthur Ogus, and Kuang-yen Shih, editors, *Hodge cycles, motives, and Shimura varieties*, volume 900 of *Lecture Notes in Mathematics*, pages 101–228. Springer-Verlag, Berlin-New York, 1982.
- DMOS82. P. Deligne, J. S. Milne, A. Ogus, and K.-Y. Shih. *Hodge cycles, motives, and Shimura varieties*, volume 900 of *Lecture Notes in Mathematics*. Springer-Verlag, Berlin-New York, 1982.
- DS91. C. Deninger and A. J. Scholl. The Beilinson conjectures. In *L-functions and arithmetic (Durham, 1989)*, volume 153 of *London Math. Soc. Lecture Note Ser.*, pages 173–209. Cambridge Univ. Press, Cambridge, 1991.
- Fic90. G. M. Fichtenholz. *Differential- und Integralrechnung. II*. Hochschulbücher für Mathematik [University Books for Mathematics], 62. VEB Deutscher Verlag der Wissenschaften, Berlin, tenth edition, 1990. Translated from the Russian by Brigitte Mai and Walter Mai.
- FJ16. J. Fresán and P. Jossen. Exponential motives, 2016. Unpublished manuscript.
- Fon92. J.-M. Fontaine. Valeurs spéciales des fonctions L des motifs. *Astérisque*, 206:Exp. No. 751, 4, 205–249, 1992. Séminaire Bourbaki, Vol. 1991/92.
- Fre14. J. Fresán. Periods of Hodge structures and special values of the gamma function, 2014. To appear in *Inventiones Math.*
- Fri82. E. M. Friedlander. *Étale homotopy of simplicial schemes*, volume 104 of *Annals of Mathematics Studies*. Princeton University Press, Princeton, N.J.; University of Tokyo Press, Tokyo, 1982.
- Fri04. B. Friedrich. Periods and algebraic de Rham cohomology, 2004. Diplomarbeit Leipzig, arXiv:math.AG/0506113v1.
- Fri12. G. Friedman. Survey article: an elementary illustrated introduction to simplicial sets. *Rocky Mountain J. Math.*, 42(2):353–423, 2012.
- Ful84. W. Fulton. *Intersection theory*, volume 2 of *Ergebnisse der Mathematik und ihrer Grenzgebiete (3) [Results in Mathematics and Related Areas (3)]*. Springer-Verlag, Berlin, 1984.
- Gar03. K. M. Gartz. *A construction of a differential graded Lie algebra in the category of effective homological motives*. ProQuest LLC, Ann Arbor, MI, 2003. Thesis (Ph.D.)—The University of Chicago.
- Gei06. T. Geisser. Arithmetic cohomology over finite fields and special values of ζ -functions. *Duke Math. J.*, 133(1):27–57, 2006.
- GGK12. M. Green, Ph. Griffiths, and M. Kerr. *Mumford-Tate groups and domains*, volume 183 of *Annals of Mathematics Studies*. Princeton University Press, Princeton, NJ, 2012. Their geometry and arithmetic.
- GH78. Ph. Griffiths and J. Harris. *Principles of algebraic geometry*. Wiley-Interscience [John Wiley & Sons], New York, 1978. Pure and Applied Mathematics.

- GM04. A. B. Goncharov and Yu. I. Manin. Multiple ζ -motives and moduli spaces $\overline{\mathcal{M}}_{0,n}$. *Compos. Math.*, 140(1):1–14, 2004.
- Göd31. K. Gödel. Über formal unentscheidbare Sätze der Principia Mathematica und verwandter Systeme I. *Monatsh. Math. Phys.*, 38(1):173–198, 1931.
- God58. R. Godement. *Topologie algébrique et théorie des faisceaux*. Actualit'es Sci. Ind. No. 1252. Publ. Math. Univ. Strasbourg. No. 13. Hermann, Paris, 1958.
- Gon97. A. B. Goncharov. The double logarithm and Manin's complex for modular curves. *Math. Res. Lett.*, 4(5):617–636, 1997.
- Gon01. A. B. Goncharov. Multiple polylogarithms and mixed Tate motives. Preprint arXiv:math.AG/0103059v4, 2001.
- Gon10. A. B. Goncharov. Hodge correlators II. *Mosc. Math. J.*, 10(1):139–188, 271–272, 2010.
- GR77. H. Grauert and R. Remmert. *Theorie der Steinschen Räume*, volume 227 of *Grundlehren der Mathematischen Wissenschaften [Fundamental Principles of Mathematical Sciences]*. Springer-Verlag, Berlin-New York, 1977.
- Gro. A. Grothendieck. Ega v. unpublished manuscript, scan available at <http://www.jmilne.org/math/Documents/>.
- Gro66. A. Grothendieck. On the de Rham cohomology of algebraic varieties. *Inst. Hautes Études Sci. Publ. Math.*, 29:95–103, 1966.
- Gro71. A. Grothendieck. *Revêtements étales et groupe fondamental (SGA 1)*, volume 204 of *Lecture Notes in Mathematics*. Springer-Verlag, Berlin-New York, 1971. Séminaire de Géométrie Algébrique du Bois Marie 1960/61, SGA1 / dir. par Alexander Grothendieck.
- Gro79. B. H. Gross. On an identity of Chowla and Selberg. *Journal of Number Theory.*, 11(3):344–348, 1979.
- Grz55. A. Grzegorzcyk. Computable functionals. *Fund. Math.*, 42:168–202, 1955.
- GS96. H. Gillet and C. Soulé. Descent, motives and K -theory. *J. Reine Angew. Math.*, 478:127–176, 1996.
- Gun90. R. C. Gunning. *Introduction to holomorphic functions of several variables. Vol. I*. The Wadsworth & Brooks/Cole Mathematics Series. Wadsworth & Brooks/Cole Advanced Books & Software, Pacific Grove, CA, 1990. Function theory.
- Hai94. R. M. Hain. Classical polylogarithms. In *Motives (Seattle, WA, 1991)*, volume 55 of *Proc. Sympos. Pure Math.*, pages 3–42. Amer. Math. Soc., Providence, RI, 1994.
- Ham83. H. A. Hamm. Zur Homotopietyp Steinscher Räume. *J. Reine Angew. Math.*, 338:121–135, 1983.
- Ham86. H. A. Hamm. Zum Homotopietyp q -vollständiger Räume. *J. Reine Angew. Math.*, 364:1–9, 1986.
- Har75. R. Hartshorne. On the De Rham cohomology of algebraic varieties. *Inst. Hautes Études Sci. Publ. Math.*, 45:5–99, 1975.
- Har77. R. Hartshorne. *Algebraic geometry*. Springer-Verlag, New York-Heidelberg, 1977. Graduate Texts in Mathematics, No. 52.
- Har16. D. Harrer. *Comparison of the Categories of Motives defined by Voevodsky and Nori*. PhD thesis, Albert-Ludwigs-Universität Freiburg, 2016. arXiv:1609.05516.
- Hat02. A. Hatcher. *Algebraic topology*. Cambridge University Press, Cambridge, 2002.
- Hen12. R. Henderson. The algebra of multiple zeta-values, 2012. Final year project, University of Durham.
- Hir64. H. Hironaka. Resolution of singularities of an algebraic variety over a field of characteristic zero. I, II. *Ann. of Math. (2)* **79** (1964), 109–203; *ibid.* (2), 79:205–326, 1964.
- Hir75. H. Hironaka. Triangulations of algebraic sets. In *Algebraic geometry (Proc. Sympos. Pure Math., Vol. 29, Humboldt State Univ., Arcata, Calif., 1974)*, pages 165–185. Amer. Math. Soc., Providence, R.I., 1975.

- HJ14. A. Huber and C. Jörder. Differential forms in the h-topology. *Algebr. Geom.*, 1(4):449–478, 2014.
- HK06. A. Huber and B. Kahn. The slice filtration and mixed Tate motives. *Compos. Math.*, 142(4):907–936, 2006.
- HMS11. A. Huber and S. Müller-Stach. On the relation between nori motives and kontsevich periods. Preprint arXiv:1105.0865, 2011.
- HO03. M. E. Hoffman and Y. Ohno. Relations of multiple zeta values and their algebraic expression. *J. Algebra*, 262(2):332–347, 2003.
- Hof97. M. E. Hoffman. The algebra of multiple harmonic series. *J. Algebra*, 194(2):477–495, 1997.
- Hub95. A. Huber. *Mixed motives and their realization in derived categories*, volume 1604 of *Lecture Notes in Mathematics*. Springer-Verlag, Berlin, 1995.
- Hub00. A. Huber. Realization of Voevodsky’s motives. *J. Algebraic Geom.*, 9(4):755–799, 2000.
- Hub04. A. Huber. Corrigendum to: “Realization of Voevodsky’s motives” [J. Algebraic Geom. 9 (2000), no. 4, 755–799; mr1775312]. *J. Algebraic Geom.*, 13(1):195–207, 2004.
- HZ87. R. M. Hain and S. Zucker. A guide to unipotent variations of mixed Hodge structure. In *Hodge theory (Sant Cugat, 1985)*, volume 1246 of *Lecture Notes in Math.*, pages 92–106. Springer, Berlin, 1987.
- IKZ06. K. Ihara, M. Kaneko, and D. Zagier. Derivation and double shuffle relations for multiple zeta values. *Compos. Math.*, 142(2):307–338, 2006.
- Ivo14. F. Ivorra. Perverse nori motives, 2014. Preprint.
- Jan90. U. Jannsen. *Mixed motives and algebraic K-theory*, volume 1400 of *Lecture Notes in Mathematics*. Springer-Verlag, Berlin, 1990. With appendices by S. Bloch and C. Schoen.
- Jan92. U. Jannsen. Motives, numerical equivalence, and semi-simplicity. *Invent. Math.*, 107(3):447–452, 1992.
- Joh89. P. T. Johnstone. Affine categories and naturally Mal’cev categories. *J. Pure Appl. Algebra*, 61(3):251–256, 1989.
- Jör14. C. Jörder. *On the Poincaré Lemma for reflexive differential forms*. PhD thesis, Albert-Ludwigs-Universität Freiburg, 2014. arXiv:1401.7495.
- Jou73. J. P. Jouanolou. Une suite exacte de Mayer-Vietoris en K -théorie algébrique. In *Algebraic K-theory, I: Higher K-theories (Proc. Conf., Battelle Memorial Inst., Seattle, Wash., 1972)*, pages 293–316. Lecture Notes in Math., Vol. 341. Springer, Berlin, 1973.
- Jou83. J.-P. Jouanolou. *Théorèmes de Bertini et applications*, volume 42 of *Progress in Mathematics*. Birkhäuser Boston, Inc., Boston, MA, 1983.
- Kal43. L. Kalmár. Egyszerű pelda eldönthetetlen aritmetikai problémára. *Matematikai és fizikai lapok*, 50:1–23, 1943.
- KB32. B. O. Koopman and A. B. Brown. On the covering of analytic loci by complexes. *Trans. Amer. Math. Soc.*, 34(2):231–251, 1932.
- KL07. M. Kerr and J. D. Lewis. The Abel-Jacobi map for higher Chow groups. II. *Invent. Math.*, 170(2):355–420, 2007.
- Kle81. S. C. Kleene. The theory of recursive functions, approaching its centennial. *Bull. Amer. Math. Soc. (N.S.)*, 5(1):43–61, 1981.
- Kle01. T. Kleinjung. *Gerahmte gemischte Tate-Motive und die Werte von Zetafunktionen zu Zahlkörpern an den Stellen 2 und 3*. Bonner Mathematische Schriften [Bonn Mathematical Publications], 340. Universität Bonn, Mathematisches Institut, Bonn, 2001. Dissertation, Rheinische Friedrich-Wilhelms-Universität Bonn, Bonn, 2000.
- KLMS06. M. Kerr, J. D. Lewis, and S. Müller-Stach. The Abel-Jacobi map for higher Chow groups. *Compos. Math.*, 142(2):374–396, 2006.
- Kni73. C. M. Knighten. Differentials on quotients of algebraic varieties. *Trans. Amer. Math. Soc.*, 177:65–89, 1973.

- Kon99. M. Kontsevich. Operads and motives in deformation quantization. *Lett. Math. Phys.*, 48(1):35–72, 1999. Moshé Flato (1937–1998).
- KS90. M. Kashiwara and P. Schapira. *Sheaves on manifolds*, volume 292 of *Grundlehren der Mathematischen Wissenschaften [Fundamental Principles of Mathematical Sciences]*. Springer-Verlag, Berlin, 1990. With a chapter in French by Christian Houzel.
- KZ01. M. Kontsevich and D. Zagier. Periods. In *Mathematics unlimited—2001 and beyond*, pages 771–808. Springer, Berlin, 2001.
- Ler97. M. Lerch. Sur quelques formules relatives au nombre de classes. *Bull. Sci. Math.*, 21:290–304, 1897.
- Lev93. M. Levine. Tate motives and the vanishing conjectures for algebraic K -theory. In *Algebraic K-theory and algebraic topology (Lake Louise, AB, 1991)*, volume 407 of *NATO Adv. Sci. Inst. Ser. C Math. Phys. Sci.*, pages 167–188. Kluwer Acad. Publ., Dordrecht, 1993.
- Lev94. M. Levine. Bloch’s higher Chow groups revisited. *Astérisque*, (226):10, 235–320, 1994. K -theory (Strasbourg, 1992).
- Lev05. M. Levine. Mixed motives. In *Handbook of K-theory. Vol. 1, 2*, pages 429–521. Springer, Berlin, 2005.
- LW09. F. Lecomte and N. Wach. Le complexe motivique de Rham. *Manuscripta Math.*, 129(1):75–90, 2009.
- Mac71. S. MacLane. *Categories for the working mathematician*. Springer-Verlag, New York-Berlin, 1971. Graduate Texts in Mathematics, Vol. 5.
- Man68. Y. I. Manin. Correspondences, motifs and monoidal transformations. *Mat. Sb. (N.S.)*, 77 (119):475–507, 1968.
- May67. J. P. May. *Simplicial objects in algebraic topology*. Van Nostrand Mathematical Studies, No. 11. D. Van Nostrand Co., Inc., Princeton, N.J.-Toronto, Ont.-London, 1967.
- Maz02. S. Mazzanti. Plain bases for classes of primitive recursive functions. *MLQ Math. Log. Q.*, 48(1):93–104, 2002.
- Mes75. W. Messing. Differentials of the first, second and third kinds. In *Algebraic geometry (Proc. Sympos. Pure Math., Vol. 29, Humboldt State Univ., Arcata, Calif., 1974)*, pages 547–561. Amer. Math. Soc., Providence, R.I., 1975.
- Mil80. J. S. Milne. *Étale cohomology*, volume 33 of *Princeton Mathematical Series*. Princeton University Press, Princeton, N.J., 1980.
- Mil12. J. Milne. Basic theory of affine group schemes, 2012. available at <http://www.jmilne.org/math/CourseNotes/AGS.pdf>.
- MM65. J. W. Milnor and J. C. Moore. On the structure of Hopf algebras. *Ann. of Math. (2)*, 81:211–264, 1965.
- Mor78. J. W. Morgan. The algebraic topology of smooth algebraic varieties. *Inst. Hautes Études Sci. Publ. Math.*, 48:137–204, 1978.
- MSWZ12. S. Müller-Stach, S. Weinzierl, and R. Zayadeh. A second-order differential equation for the two-loop sunrise graph with arbitrary masses. *Commun. Number Theory Phys.*, 6(1):203–222, 2012.
- MSWZ14. S. Müller-Stach, S. Weinzierl, and R. Zayadeh. Picard-Fuchs equations for Feynman integrals. *Comm. Math. Phys.*, 326(1):237–249, 2014.
- Mum66. D. Mumford. Families of abelian varieties. In *Algebraic Groups and Discontinuous Subgroups (Proc. Sympos. Pure Math., Boulder, Colo., 1965)*, pages 347–351. Amer. Math. Soc., Providence, R.I., 1966.
- MVW06. C. Mazza, V. Voevodsky, and C. Weibel. *Lecture notes on motivic cohomology*, volume 2 of *Clay Mathematics Monographs*. American Mathematical Society, Providence, RI; Clay Mathematics Institute, Cambridge, MA, 2006.
- NA85. V. Navarro Aznar. Sur la théorie de Hodge des variétés algébriques à singularités isolées. *Astérisque*, 130:272–307, 1985. Differential systems and singularities (Luminy, 1983).

- Nora. M. V. Nori. Motives. Handwritten notes, distributed around 1997 in the Esnault–Viehweg seminar at Essen, unpublished, 27 pages.
- Norb. M. V. Nori. Periods. Unpublished handwritten notes titled "Periods", sent to us by M. Nori in Sept. 2011 (21 pages).
- Nor82. M. V. Nori. The fundamental group-scheme. *Proc. Indian Acad. Sci. Math. Sci.*, 91(2):73–122, 1982.
- Nor00. M. V. Nori. Lectures at TIFR, 2000. LaTeX notes by N. Fakhruddin, unpublished, 32 pages.
- Nor02. M. V. Nori. Constructible sheaves. In *Algebra, arithmetic and geometry, Part I, II (Mumbai, 2000)*, volume 16 of *Tata Inst. Fund. Res. Stud. Math.*, pages 471–491. Tata Inst. Fund. Res., Bombay, 2002.
- Pan03. I. Panin. Push-forwards in oriented cohomology theories of algebraic varieties: Ii, after I. Panin and A. Smirnov. Preprint Nr. 619, K-theory preprint archive, see <http://www.math.uiuc.edu/K-theory/0619/>, 2003.
- Pat15. D. Patel. Motivic structures on higher homotopy groups of hyperplane arrangements. *Math. Annalen*, 2015.
- Prü24. H. Prüfer. Theorie der Abelschen Gruppen. *Math. Z.*, 20(1):165–187, 1924.
- PS08. C. Peters and J. Steenbrink. *Mixed Hodge structures*, volume 52 of *Ergebnisse der Mathematik und ihrer Grenzgebiete. 3. Folge. A Series of Modern Surveys in Mathematics [Results in Mathematics and Related Areas. 3rd Series. A Series of Modern Surveys in Mathematics]*. Springer-Verlag, Berlin, 2008.
- Qui69. D. Quillen. Rational homotopy theory. *Ann. of Math. (2)*, 90:205–295, 1969.
- Ren05. L. E. Renner. *Linear algebraic monoids*, volume 134 of *Encyclopaedia of Mathematical Sciences*. Springer-Verlag, Berlin, 2005. Invariant Theory and Algebraic Transformation Groups, V.
- Ric54. H. G. Rice. Recursive real numbers. *Proc. Amer. Math. Soc.*, 5:784–791, 1954.
- Sab96. C. Sabbah. On the comparison theorem for elementary irregular D -modules. *Nagoya Math. J.*, 141:107–124, 1996.
- Sch. A. J. Scholl. Extensions of motives and higher chow groups. unpublished notes.
- Sch35. Th. Schneider. Transzendenzenuntersuchungen periodischer Funktionen II. Transzendenzeigenschaften elliptischer Funktionen. *J. Reine Angew. Math.*, 172:70–74, 1935.
- Sch57. Th. Schneider. Einführung in die transzendenten zahlen. 1957.
- Sch91. A. J. Scholl. Remarks on special values of L -functions. In *L-functions and arithmetic (Durham, 1989)*, volume 153 of *London Math. Soc. Lecture Note Ser.*, pages 373–392. Cambridge Univ. Press, Cambridge, 1991.
- Sch03. J. Schürmann. *Topology of singular spaces and constructible sheaves*, volume 63 of *Instytut Matematyczny Polskiej Akademii Nauk. Monografie Matematyczne (New Series) [Mathematics Institute of the Polish Academy of Sciences. Mathematical Monographs (New Series)]*. Birkhäuser Verlag, Basel, 2003.
- Sch07. A.J. Scholl. Integral elements of K-theory and products of modular curves II, 2007. Preprint, arXiv:0710.5453.
- Sch12a. J. Scholbach. f -cohomology and motives over number rings. *Kodai Math. J.*, 35(1):1–32, 2012.
- Sch12b. J. Scholbach. Geometric motives and the h-topology. *Math. Z.*, 272(3-4):965–986, 2012.
- SD72. B. Saint-Donat. Exp. vbis: Techniques de descent cohomologique,. In *Théorie des topos et cohomologie étale des schémas. Tome 1*, volume 270 of *Lecture Notes in Mathematics*, pages 83–162. Springer-Verlag, Berlin-New York, 1972. Séminaire de Géométrie Algébrique du Bois-Marie 1963–1964 (SGA 4), Dirigé par M. Artin, A. Grothendieck et J. L. Verdier. Avec la collaboration de N. Bourbaki, P. Deligne et B. Saint-Donat.
- Sei54. A. Seidenberg. A new decision method for elementary algebra. *Ann. of Math. (2)*, 60:365–374, 1954.

- Ser56. J.-P. Serre. Géométrie algébrique et géométrie analytique. *Ann. Inst. Fourier, Grenoble*, 6:1–42, 1955–1956.
- Sil86. J. H. Silverman. *The arithmetic of elliptic curves*, volume 106 of *Graduate Texts in Mathematics*. Springer-Verlag, New York, 1986.
- Sko62. Th. Skolem. Proof of some theorems on recursively enumerable sets. *Notre Dame J. Formal Logic*, 3:65–74, 1962.
- Spa66. E. H. Spanier. *Algebraic topology*. McGraw-Hill Book Co., New York-Toronto, Ont.-London, 1966.
- Spe49. E. Specker. Nicht konstruktiv beweisbare Sätze der Analysis. *J. Symbolic Logic*, 14:145–158, 1949.
- SR72. N. Saavedra Rivano. *Catégories Tannakiennes*. Lecture Notes in Mathematics, Vol. 265. Springer-Verlag, Berlin-New York, 1972.
- Str07. R. Street. *Quantum groups*, volume 19 of *Australian Mathematical Society Lecture Series*. Cambridge University Press, Cambridge, 2007. A path to current algebra.
- Sul77. D. Sullivan. Infinitesimal computations in topology. *Inst. Hautes Études Sci. Publ. Math.*, 47:269–331 (1978), 1977.
- Tei82. B. Teissier. Variétés polaires. II. Multiplicités polaires, sections planes, et conditions de Whitney. In *Algebraic geometry (La Rábida, 1981)*, volume 961 of *Lecture Notes in Math.*, pages 314–491. Springer, Berlin, 1982.
- Ter02. T. Terasoma. Mixed Tate motives and multiple zeta values. *Invent. Math.*, 149(2):339–369, 2002.
- Tur36. A. M. Turing. On Computable Numbers, with an Application to the Entscheidungsproblem. *Proc. London Math. Soc.*, S2-42(1):230, 1936.
- TZ10. K. Tent and M. Ziegler. Computable functions of reals. *Münster J. Math.*, 3:43–65, 2010.
- Ver72. J.-L. Verdier. Cohomologie dans les topos, exposé V. In *Théorie des topos et cohomologie étale des schémas. (SGA 4) Tome 2*, volume 270 of *Lecture Notes in Mathematics*, pages iv+418. Springer-Verlag, Berlin-New York, 1972. Séminaire de Géométrie Algébrique du Bois-Marie 1963–1964 (SGA 4), Dirigé par M. Artin, A. Grothendieck et J. L. Verdier. Avec la collaboration de N. Bourbaki, P. Deligne et B. Saint-Donat.
- Vis05. A. Vistoli. Grothendieck topologies, fibered categories and descent theory. In *Fundamental algebraic geometry*, volume 123 of *Math. Surveys Monogr.*, pages 1–104. Amer. Math. Soc., Providence, RI, 2005.
- Voe96. V. Voevodsky. Homology of schemes. *Selecta Math. (N.S.)*, 2(1):111–153, 1996.
- VSF00. V. Voevodsky, A. Suslin, and E. M. Friedlander. *Cycles, transfers, and motivic homology theories*, volume 143 of *Annals of Mathematics Studies*. Princeton University Press, Princeton, NJ, 2000.
- vW11. J. von Wangenheim. Nori-Motive und Tannaka-Theorie, 2011. Diplomarbeit Albert-Ludwigs-Universität Freiburg, arXiv:1111.5146.
- Wal08. M. Waldschmidt. Elliptic functions and transcendence. In *Surveys in number theory*, volume 17 of *Dev. Math.*, pages 143–188. Springer, New York, 2008.
- War83. F. W. Warner. *Foundations of differentiable manifolds and Lie groups*, volume 94 of *Graduate Texts in Mathematics*. Springer-Verlag, New York-Berlin, 1983. Corrected reprint of the 1971 edition.
- Wat79. W. C. Waterhouse. *Introduction to affine group schemes*, volume 66 of *Graduate Texts in Mathematics*. Springer-Verlag, New York-Berlin, 1979.
- Wed04. T. Wedhorn. On Tannakian duality over valuation rings. *J. Algebra*, 282(2):575–609, 2004.
- Wei94. C. A. Weibel. *An introduction to homological algebra*, volume 38 of *Cambridge Studies in Advanced Mathematics*. Cambridge University Press, Cambridge, 1994.
- Wei15. Th. Weißschuh. *A strictly commutative higher cycle map into Deligne-Beilinson cohomology*. PhD thesis, Universität Mainz, 2015. arXiv:1410.4686.

- Wüs12. G. Wüstholz. Leibniz' conjecture, periods & motives. In *Colloquium De Giorgi 2009*, volume 3 of *Colloquia*, pages 33–42. Ed. Norm., Pisa, 2012.
- Yam10. G. Yamashita. Bounds for the dimensions of p -adic multiple L -value spaces. *Doc. Math.*, Extra volume: Andrei A. Suslin sixtieth birthday:687–723, 2010.
- Yos08. M. Yoshinaga. Periods and elementary real numbers, 2008. arXiv:0805.0349.
- Zag94. D. Zagier. Values of zeta functions and their applications. In *First European Congress of Mathematics, Vol. II (Paris, 1992)*, volume 120 of *Progr. Math.*, pages 497–512. Birkhäuser, Basel, 1994.
- Zha00. J. Zhao. Analytic continuation of multiple zeta functions. *Proc. Amer. Math. Soc.*, 128(5):1275–1283, 2000.
- Zha02. J. Zhao. Multiple polylogarithms: analytic continuation, monodromy, and variations of mixed Hodge structures. In *Contemporary trends in algebraic geometry and algebraic topology (Tianjin, 2000)*, volume 5 of *Nankai Tracts Math.*, pages 167–193. World Sci. Publ., River Edge, NJ, 2002.
- Zha04. J. Zhao. Variations of mixed Hodge structures of multiple polylogarithms. *Canad. J. Math.*, 56(6):1308–1338, 2004.
- Zha07. J. Zhao. Analytic continuation of multiple polylogarithms. *Anal. Math.*, 33(4):301–323, 2007.

Index

- Δ -complex, 37
- 2-colimit, 145

- Abel–Jacobi class, 346
- Abel–Jacobi map, 341
- Absolute Hodge motive, 123, 127, 231
- Abstract simplicial complex, 36
- Acyclic sheaf, 11
- Admissible string, 312
- Algebraic de Rham cohomology, 74, 88
- Amplitude, 338
- Analytic space, 5
- André motive, 119, 235
- Antipode, 142
- Artin motive, 224
- Artin vanishing, 58
- Artin–Tate motive, 282
- Ayoub period power series, 283

- Base change, 136
- Basic lemma, 45, 47
- Beilinson conjecture, 335, 337

- Category of coalgebras, 170
- Category of mixed Tate motives, 130
- Category of motives, 226
- Čech cohomology, 14
- Čech complex, 13
- Chow motive, 117
- Chowla–Lerch–Selberg formula, 298
- Coalgebra, 142
- Cohomological periods, 252
- Cohomology with support, 216
- Comodule, 138
- Comparison functors, 231
- Complex, 6
- Computable function, 348

- Computable number, 348
- Constructible sheaf, 46
- Contragredient (co)module, 170
- Corestriction functor, 228
- Correspondences, 119
- Cosimplicial objects, 15
- Covering family, 19
- CW-complex, 38

- De Rham cohomology, 271
- De Rham complex, 73
- Derived category, 7
- Determinant of period matrix, 298
- Diagram, 135
- Diagram category, 138
- Diagram of pairs, 210
- Differential form, 73
- Differential of the first kind, 300
- Differential of the second kind, 300
- Differential of the third kind, 300
- Differentials of the higher kind, 299
- Dilogarithm, 319
- Discriminant, 294
- Divisor with normal crossings, 4
- Dold–Kan correspondence, 19
- Double logarithm, 319, 328
- Double shuffle, 316

- Effective good pair, 210
- Effective period, 245
- Eisenstein numbers, 299
- Elementary function, 349
- Elliptic curves, 294
- Endomorphism of a representation, 136
- Evaluation map, 274
- Exponential Nori motive, 347
- Exponential periods, 346

- Feynman periods, 338
- Feynman–Schwinger trick, 339
- Fibre functor, 107, 119, 135, 191, 271
- Filtration bête, 7
- Fine resolution, 11, 35
- Flasque sheaf, 10
- Formal Ayoub periods, 283
- Formal period, 201, 271
- Fpqc-topology, 23

- Gaussian integers, 299
- Geometric motive, 90, 92, 119, 121, 220, 231
- Godement resolution, 11
- Good pairs, 210
- Graded diagram, 176
- Griffiths intermediate Jacobian, 342
- Grothendieck motive, 117, 235
- Grothendieck period conjecture, 276, 299
- Grothendieck topology, 19
- Group scheme, 143

- h'-topology, 70
- h-topology, 70
- Heart of a t-structure, 56
- Heawood graph, 37
- Higher Chow group, 342
- Holomorphic de Rham cohomology, 97
- Holomorphic de Rham complex, 97
- Holomorphic differentials, 97
- Hopf algebra, 142
- Hypercover, 18, 21, 88
- Hyperlogarithm, 318

- Injective resolution, 10
- Intermediate Jacobian, 342

- Jacobian variety, 341

- Künneth formula for pairs, 41
- Kontsevich integral, 310
- Kontsevich–Zagier conjecture, 275
- Kontsevich–Zagier period, 245, 260, 305

- Lefschetz motive, 118, 206
- Legendre relation, 297
- Limiting mixed Hodge structure, 330
- Linear algebraic representation, 184
- Localisation of diagrams, 186
- Localised diagram, 186
- Logarithm, 289
- Logarithmic pole, 81, 300
- Loop integral, 338
- Lower elementary function, 349

- Lyndon word, 317

- Meromorphic 1-form, 280, 300
- Middle perversity, 57
- Mixed Hodge structure, 82, 124
- Mixed motive, 117, 121, 127, 231
- Mixed Nori motive, 206
- Mixed realisation complexes, 126
- Mixed realisations, 124
- Mixed Tate motive, 128, 130, 131, 305, 317
- Monoid scheme, 143
- Mordell–Weil group, 337
- Motivated cycles, 118
- Motive, 226, 231
- Motive of a Deligne–Mumford stack, 257
- Motive with support, 218
- Motivic cohomology, 120
- Motivic Galois group, 207
- Multiple polylogarithm, 305, 318, 319
- Multiple zeta values, xii, 305, 308, 318
- Mumford–Tate group, 279, 281, 282

- Naive period, 245, 259
- NC-period, 245
- Neutral Tannakian category, 142
- Non-degenerate part of simplicial variety, 18
- Non-periods, 347
- Nori motive, 206, 220, 226, 231, 271, 342
- Normal cone, 221

- Path category, 136
- Perfect duality, 189
- Period, 245, 252, 254, 256
- Period algebra, 252, 256
- Period conjecture, 280
- Period isomorphism, 110, 111, 114
- Period number, 245
- Period pairing, 110, 112, 115
- Period, naive, 259
- Periods of 0-dimensional varieties, 285
- Periods of absolute Hodge motives, 256
- Periods of curves, 299
- Periods of cycles, 340
- Periods of elliptic curves, 297, 298
- Periods of geometric motives, 256
- Periods of homotopy groups, 344
- Periods of mixed Tate motives, 317
- Periods of moduli spaces, 318
- Periods of motives, 256
- Perverse sheaf, 52
- Picard–Fuchs equation, 340
- Poincaré duality for pairs, 43
- Polylogarithm, 305

- Presheaf, 20
- Proper descent, 72
- Proper hypercover, 18
- Proper morphism, 5
- Pseudo-abelian category, 117
- Pure motive, 117, 127, 236
- Pure Nori motive, 235, 236

- Quadratic form, 292
- Quantum field theory, 338
- Quasi-isomorphism, 6
- Quasi-period, 297, 302

- Rational 1-form, 300
- Recursion, 348
- Relations among multiple zeta values, 312
- Relative cohomology, 31, 216
- Relative de Rham cohomology, 84
- Representation of a diagram, 136
- Restriction functor, 226
- Riemann's bilinear relations, 303
- Right module in \mathcal{A} , 148
- Rigid tensor category, 189
- Rigidified cover, 212
- Rigidity, 135, 142, 189, 193, 207, 220, 222, 234

- Semi-algebraic set, 60
- Sheaf, 20
- Sheaf cohomology, 10
- Sheaf of differential forms, 73
- Shuffle product, 313
- Shuffle/Stuffle relations, 312
- Siegel upper half space, 303
- Simplex, 36
- Simplicial cohomology, 38
- Simplicial complex, 36
- Simplicial objects, 15
- Simplicial set, 37
- Simplicial simplex, 16

- Singular (co)homology, 35, 71
- Singular cohomology, 271
- Singular simplex, 34
- Site, 19
- Situs, 19
- Skeletal filtration, 17
- Smooth correspondences, 4
- Standard simplex, 36
- Stuffle product, 313, 314
- Sum relation, 310

- T-structure, 56
- Tannaka duality, 142
- Tate motive, 121, 282
- Tetrahedron, 37, 39
- Topological epimorphism, 83
- Topological realisation, 37
- Topological simplex, 34
- Torsor, 22, 24, 26, 198
- Torus, 37, 39
- Transcendence basis for multiple zeta values, 317
- Triangulation, 36, 59
- Trivial filtration, 7
- Turing computability, 348

- Unipotent variation of Hodge structures, 330
- Unramified mixed Tate motive, 131, 305, 317

- Very good pair, 210
- Voevodsky category, 119

- Weakly constructible sheaf, 46
- Weights, 231, 235, 236
- Weil–Châtelet group, 297
- Whitney stratification, 46

- ζ -value, 262

Glossary

General notation

k	Field, usually characteristic zero or even embedded into \mathbb{C}	
R	Commutative ring, usually noetherian	
$k\text{-Vect}$	Category of f.d. k -vector space	
$R\text{-Mod}$	Category of f.g. R -modules	
$R\text{-Comod}$	Category of f.g. R -comodules	
$R\text{-Proj}$	Category of f.g. projective R -modules	
\mathbb{A}^n	Affine space	
\mathbb{P}^n	Projective space	
\mathbb{G}^m	Multiplicative group scheme	
$\text{Spec}(R)$	Spectrum of a ring	
$k(X)$	Function field of an irreducible variety X over k	
\mathbb{C}	Complex numbers	
\mathbb{N}	Natural numbers	
\mathbb{Q}	Rational numbers	
$\overline{\mathbb{Q}}$	Algebraic numbers	
$\widetilde{\mathbb{Q}}$	Real algebraic numbers	
\mathbb{Z}	Integers	
$\text{Sh}(X)$	Category of sheaves of abelian groups on X	
$\text{Gal}(\bar{k}/k)$	Absolute Galois group	
$R^q\pi_*$	Direct image functor	
Γ	Global section functor	
RI	Derived global section functor	
X^{an}	Analytic space associated to a variety X	5
\mathcal{I}^\bullet	Injective resolution	10
$Gd^\bullet(\mathcal{F})$	Godement resolution	11
$\text{sq}_k, \text{cosq}_k$	(Co)Skeleton filtration	17
$N(X_\bullet)$	Non-degenerate part of simplicial variety X_\bullet	18
Δ_n	Topological singular simplex	34
$(D^{\leq 0}, D^{\geq 0})$	t-structure	56
Ω_X^\bullet	Algebraic (or holomorphic) differential forms	73, 97
$\Omega_X^\bullet\langle D \rangle$	Differential forms with log poles in D	81
Ω_h^\bullet	Sheaf of differential forms in h -topology	83
\hat{X}	Formal completion	90
per	Period isomorphism	110
$N_Z X$	Normal bundle of Z in X	221
res, cores	(Co)Restriction	226, 227
Δ	Triple coproduct for torsor	290
disc	Discriminant of quadratic form	294
$\zeta(n)$	Riemann zeta-function	308
$\zeta(s_1, \dots, s_k)$	Multiple zeta-value	308
III	Shuffle product	313
*	Stuffle product	315
$\bar{M}_{g,n}$	Moduli space of stable curves	318
$\text{Li}_{m_1, \dots, m_n}$	Multiple polylogarithm	319
$\text{AJ}^{q,n}$	Higher Abel-Jacobi map	342
$\mathbb{R}_{\text{comp}}, \mathbb{C}_{\text{comp}}$	Computable real and complex numbers	348

Categories and motives

$\text{Mor}_{\mathcal{C}}(X, Y)$	Morphisms in a category \mathcal{C}	3
Var	Category of varieties	3
Sch	Category of schemes	3
Sm	Category of smooth varieties	3
Aff	Category of affine varieties	3
$\mathbb{Z}[\text{Var}]$	Linearised category of varieties	3
$\mathbb{Z}[\text{Sm}]$	Linearised category of smooth schemes	3-4
$\mathbb{Z}[\text{Aff}]$	Linearised category of affine schemes	3-4
SmCor	Category of smooth correspondences	3-4, 119
$\text{SmCor}_{\mathbb{Q}}$	SmCor with rational coefficients	3-4, 119
Cor	Finite correspondences	3-4
An	Category of analytic spaces	5
$\text{Cone}(f)$	Cone complex	6
\mathcal{C}^b	Category of bounded complexes	6
K^b	Homotopy category	6
D^b	Bounded derived category	7
$F^{\geq p}\tau_{\leq p}K^{\bullet}$	Trivial (bête) filtration	7
$\tau_{\leq p}\tau_{\leq p}K^{\bullet}$	Canonical filtration	7
$\text{Tot}(K^{\bullet, \bullet})$	Total complex of a double complex	8
$\text{Sh}(X)$	Category of sheaves of abelian groups over X	10
$D_{(k, \mathbb{Q})}^+$	Triangulated category of cohomological (k, \mathbb{Q}) -Vect complexes	108
CHM	Category of Chow motives	117
GRM	Category of Grothendieck motives	117
L	Lefschetz Chow motive	118
AM	Category of André motives	119
$\mathbb{Z}(1)$	Tate motive	120
DM_{gm}	Triangulated category of geometric motives	120
$DM_{\text{gm}, \mathbb{Q}}$	DM_{gm} with rational coefficients	120
\mathcal{MR}	Category of mixed realisations	124
MHS	Category of mixed Hodge structures	124
\mathcal{MM}_{AH}	Category of absolute Hodge motives	127
DTM	Triangulated category of mixed Tate motives	130
MTM_{gm}	Abelian category of mixed Tate motives	130
MTM^f	Subcategory of unramified mixed Tate motives	131
$\text{End}_{\mathcal{A}}(p)$	Endomorphism algebra of object p in category \mathcal{A}	148
$A_{1,2}$	Formal periods, i.e., coordinate algebra of $X_{1,2}$	194
$X_{1,2}$	Torsor of isomorphisms between de T_1 and T_2	196
$\mathcal{MM}_{\text{Nori}}$	Category of Nori motives	206
$H_{\text{Nori}}^i(X, Y)$	Nori motive associated to the pair (X, Y)	206
$G_{\text{mot}}(k, \mathbb{Z})$	Motivic Galois group over \mathbb{Z}	207
$G_{\text{mot}}(k, \mathbb{Q}) = G_{\text{mot}}(k)$	Motivic Galois group over \mathbb{Q}	207
W_{\bullet}	Weight filtration for Nori motives	236
U_{mot}	Pro-unipotent motivic Galois group	238
$G_{\text{mot}}^{\text{pure}}$	Pro-reductive motivic Galois group	238
$\mathbf{1}(n)$	Nori Tate motive	239
$MTM_{\text{Nori}, \mathbb{Q}}$	Category of Nori mixed Tate motives	239
$MTM_{\text{Nori}, \mathbb{Q}}^f$	Category of unramified Nori mixed Tate motives	240
$L(M, s)$	L-function of a motive	336
$M_{\text{B}}, M_{\text{dR}}$	Betti- and de Rham realization of a motive	337
$H^i(X, Y; f)$	Exponential Nori motive	347

Diagrams

D	Diagram (quiver, graph)	135
$V(D)$	Vertices of a diagram	135
$E(D)$	Edges of a diagram	135
$D(\mathcal{C})$	Diagram of a (small) category \mathcal{C}	136
T	Representation of a diagram	136
$\mathcal{C}(D, T)$	Diagram category for D and T	137
$A(D, T)$	Coalgebra of diagram category	138
$\text{Pairs}^{\text{eff}}$	Diagram of (effective) pairs	205
Good^{eff}	Diagram of (effective) good pairs	210
$\text{VGood}^{\text{eff}}$	Diagram of (effective) very good pairs	210

Periods

$P_{1,2}$	Formal periods	201
\mathbb{P}_{nc}	Normal crossing periods	245
\mathbb{P}	Cohomological periods	252
\mathbb{P}_{Sm}	Periods of (complexes of) smooth varieties	254
$\mathbb{P}_{\text{SmAff}}$	Periods of (complexes of) smooth affine varieties	254
\mathbb{P}_{gm}	Voevodsky periods	256
\mathbb{P}_{Nori}	Nori periods	256
\mathbb{P}_{AH}	Absolute Hodge periods	256
\mathbb{P}_{nv}	Naive periods	259
\mathbb{P}_{KZ}	Kontsevich–Zagier periods	260
$\tilde{\mathbb{P}}$	Formal periods	271
$\mathcal{O}_{k\text{-alg}}(\bar{\mathbb{D}}^\infty)$	Ayoub power series	283
$\tilde{\mathbb{P}}_{\text{Ay}}^\dagger$	Ayoub power series of periods	284
$\omega_1, \omega_2, \eta_1, \eta_2$	(Quasi-)Periods of elliptic curve	297

Cohomology groups

$H^i(X, Y)$	Relative cohomology	31
$H_Z^i(X, Y)$	Relative cohomology with supports	33
$S_n(X)$	Singular n -chains	34
$S^n(X)$	Singular n -cochains	34
$S_n^\infty(X)$	Differentiable singular n -chains	34
$S_\infty^n(X)$	Differentiable singular n -cochains	34
H_*^{sing}	Singular homology	35
$H_*^{\text{sing}, \infty}$	Differentiable singular homology	35
H_{sing}^*	Singular cohomology	35
$H_{\text{sing}, \infty}^*$	Differentiable sSingular cohomology	35
$H_{h'}^i(X, \mathcal{F})$	Cohomology in h' -topology	70
H_{dR}^*	(Algebraic) De Rham cohomology	73

Motivic cohomology groups

$H_{\mathcal{M}}^p(X, \mathbb{Z}(q))$	Motivic cohomology	121
$Ch^q(X, n)$	Higher Chow group	121
$K_n(X)^{(q)}$	Adams eigenspace of algebraic k -group	121